



CMD69423P

2-Port MIMO Ceiling Mount Antenna

698-960 MHz/1300-4200 MHz

The CMD69423P, using patent pending technology, is an indoor, low PIM, 2-port, omni-directional, ceiling mount antenna. The antenna is designed to deliver best-in-class performance for indoor requirements, operating between 698-960 MHz and 1300-4200 MHz. The individual antenna elements are designed with linear, vertical, and horizontal components and are optimized to radiate a specifically shaped pattern for optimal performance when installed on a ceiling.

FEATURES AND BENEFITS

- Wide bandwidth: 698-960 MHz and 1300-4200 MHz
- Services CBRS and 5G spectrum to 4200 MHz
- Low profile aesthetically-neutral housing
- Full Plenum rating
- Low port-to-port correlation, ensuring optimal MIMO performance
- Low PIM

ELECTRICAL SPECIFICATION

Operating Frequency (MHz)	698-806	824 – 960	1350 – 1550	1690 – 2180	2300 – 2700	3300 - 4200
Number of Ports	2 x 2 MIMO					
VSWR - Max	2:1					
Gain (dBi) - Max	3.9	5.3	6.0	6.1	6.8	6.7
PIM - 2x20W (dBc)	< -150					
Isolation Port 1 - 2 (dB) - Max	-15	-15	-15	-16	-26	-20
Nominal Impedance (Ohms)	50					
Max Power - Ambient 25°C (W)	50					
Polarization	Linear, vertical and horizontal					
Vertical Plane 3 dB Beamwidth Port N	See radiation patterns					
Horizontal Plane 3 dB Beamwidth Port N	See radiation patterns					

MECHANICAL SPECIFICATION

Dimensions - diameter x height - mm (inches)	218.7 x 43.5 (8.6 x 1.71)
Weight - g (lbs.)	430 (0.95)
Cable Length cm (in)	30 (11.8)
Radome Material	PC + ABS
Mounting	Ceiling mount (flush mount with screws and anchors)

ENVIRONMENTAL SPECIFICATION

Operating Environment (Indoor or Outdoor)	Indoor
Operating Temperature - °C (°F)	-30 to +70°C (-22 to +158°F)
Storage Temperature - °C (°F)	-40 to +85°C (-22 to +158°F)
Flammability Rating	UL94-V0
Material Substance Compliance	RoHS
Standard for Safety: Information Technology Equipment	UL/CSA/EN/IEC/CB-Scheme 60950-1 Listed
Standard for Safety: Fire and Smoke (Plenum)*	UL 2043 Certified

CONFIGURATION

PART NUMBER	CABLE LENGTH	CONNECTOR	PACKAGING
CMD69423P-30D43F	Dual 30 cm	Dual Female 4.3-10	Unit-packed
CMD69423P-30NF	Dual 30 cm	Dual Female N	Unit-packed
CMD69423P-B30D43F	Dual 30 cm	Dual Female 4.3-10	Bulk-packed
CMD69423P-B30NF	Dual 30 cm	Dual Female N	Bulk-packed

PACKAGING INFORMATION

PART NUMBER	DESCRIPTION
161-00155	Master carton
161-00070-B	Carton insert
161-00070-A	Unit carton

PACKAGED DIMENSION	CARTON	AIR PALLET	OCEAN PALLET
Number of Antennas	3	72	90
Height - cm (in.)	31.7 (12.48)	141.0 (55.51)	173.0 (68.11)
Length - cm (in.)	53.4 (21.02)	120.0 (47.24)	120.0 (47.24)
Width - cm (in.)	26.5 (10.43)	80.0 (31.50)	80.0 (31.50)
Shipping Weight - kg (lb.)	-	122 (270.0)	145 (320.0)

PACKAGED DIMENSION -BULK	CARTON	AIR PALLET	OCEAN PALLET
Number of Antennas	8	192	240
Height - cm (in.)	31.7 (12.48)	141.0 (55.51)	173.0 (68.11)
Length - cm (in.)	53.4 (21.02)	120.0 (47.24)	120.0 (47.24)
Width - cm (in.)	26.5 (10.43)	80.0 (31.50)	80.0 (31.50)
Shipping Weight - kg (lb.)	-	155 (341.7)	185 (407.9)

MECHANICAL DRAWING

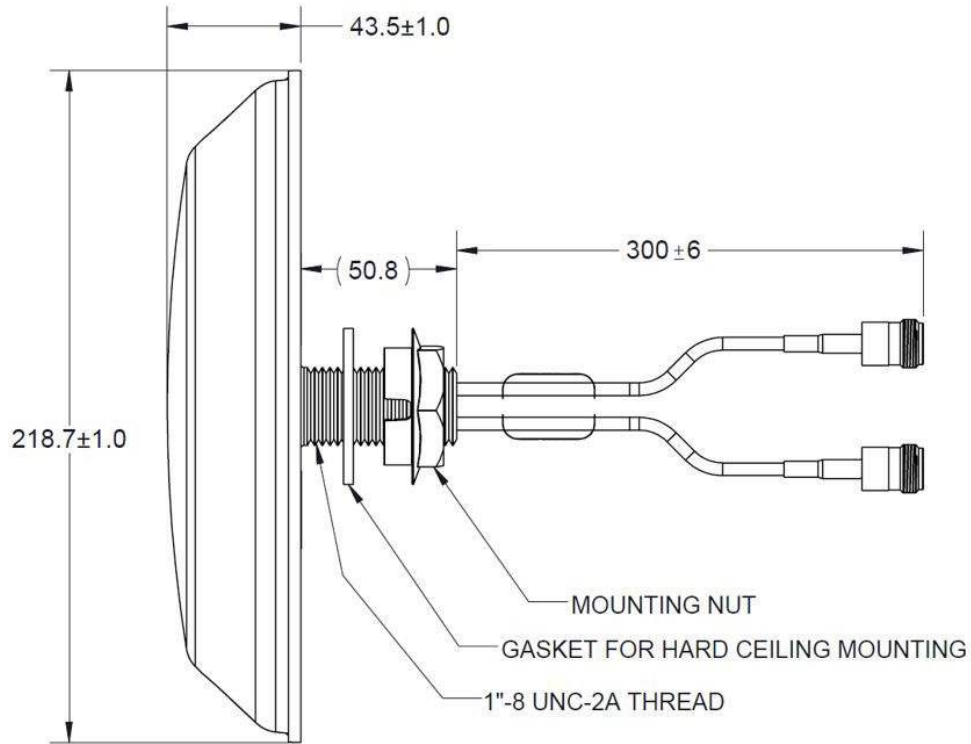

RADIATION PATTERNS

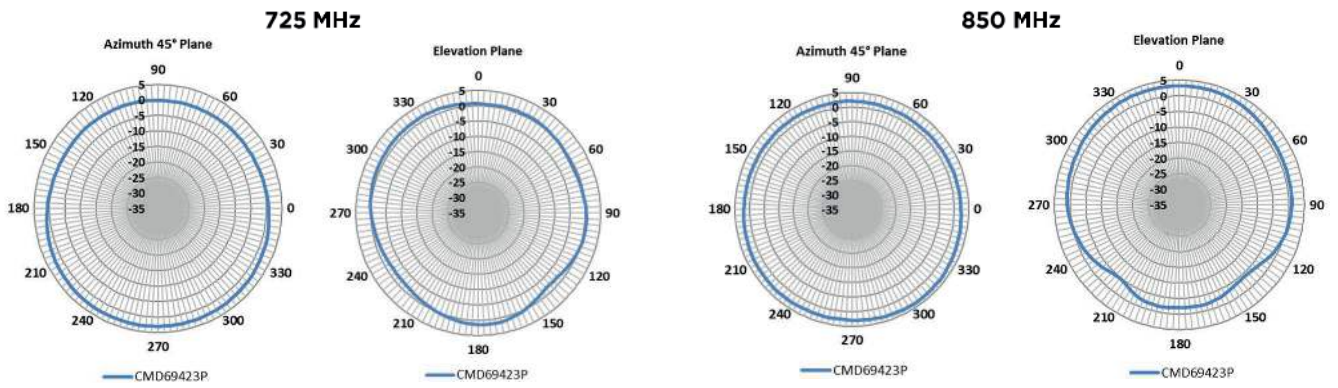

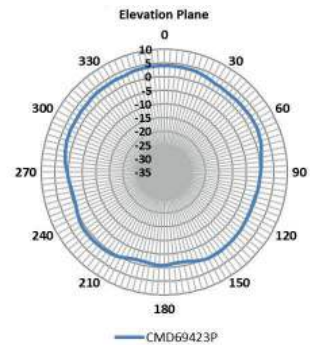
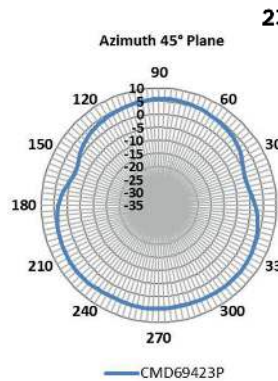
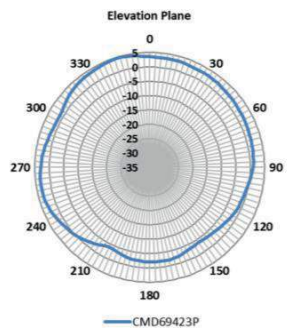
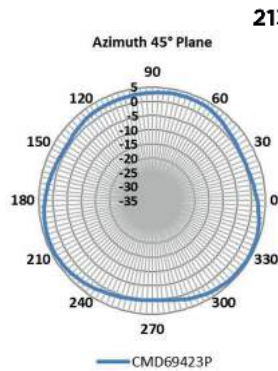
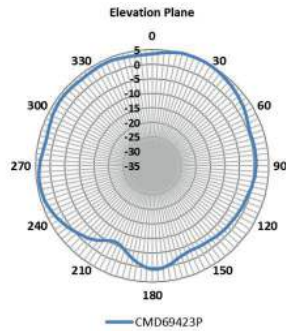
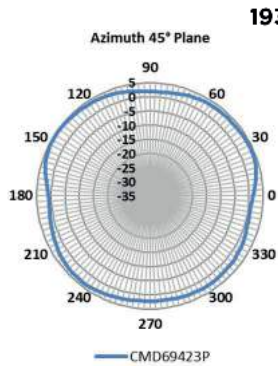
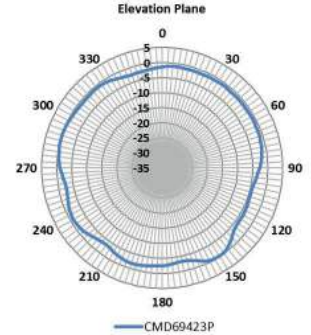
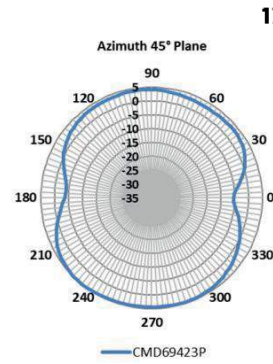
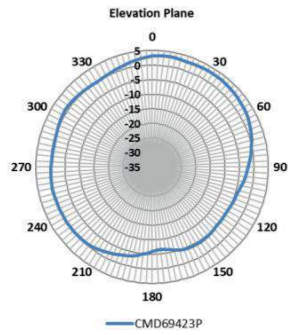
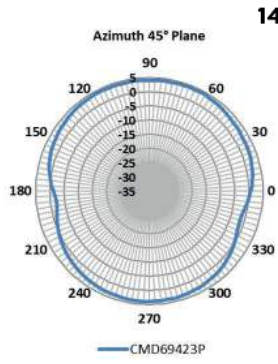

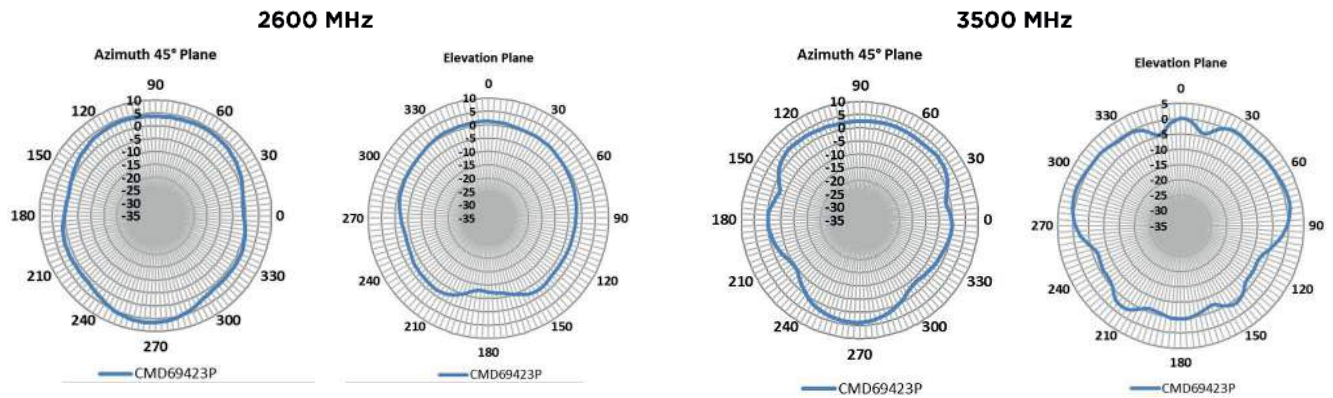

TE TECHNICAL SUPPORT CENTER

USA:	+1 (800) 522-6752
Canada:	+1 (905) 475-6222
Mexico:	+52 (0) 55-1106-0800
Latin/S. America:	+54 (0) 11-4733-2200
Germany:	+49 (0) 6251-133-1999
UK:	+44 (0) 800-267666
France:	+33 (0) 1-3420-8686
Netherlands:	+31 (0) 73-6246-999
China:	+86 (0) 400-820-6015

te.com

TE Connectivity, TE Connectivity (logo) and Every Connection Counts are trademarks. All other logos, products and/or company names referred to herein might be trademarks of their respective owners.

The information given herein, including drawings, illustrations and schematics which are intended for illustration purposes only, is believed to be reliable. However, TE Connectivity makes no warranties as to its accuracy or completeness and disclaims any liability in connection with its use.

TE Connectivity's obligations shall only be as set forth in TE Connectivity's Standard Terms and Conditions of Sale for this product and in no case will TE Connectivity be liable for any incidental, indirect or consequential damages arising out of the sale, resale, use or misuse of the product. Users of TE Connectivity products should make their own evaluation to determine the suitability of each such product for the specific application.

TE warrants to the original end user customer of its products that its products are free from defects in material and workmanship. Subject to conditions and limitations TE will, at its option, either repair or replace any part of its products that prove defective because of improper workmanship or materials. This limited warranty is in force for the useful lifetime of the original end product into which the TE product is installed. Useful lifetime of the original end product may vary but is not to exceed five (5) years from the original date of the end product purchase.

©2021 TE Connectivity. All Rights Reserved.

12/21 Original

