

Notification about the transfer of the semiconductor business

The semiconductor business of Panasonic Corporation was transferred on September 1, 2020 to Nuvoton Technology Corporation (hereinafter referred to as "Nuvoton"). Accordingly, Panasonic Semiconductor Solutions Co., Ltd. became under the umbrella of the Nuvoton Group, with the new name of Nuvoton Technology Corporation Japan (hereinafter referred to as "NTCJ").

In accordance with this transfer, semiconductor products will be handled as NTCJ-made products after September 1, 2020. However, such products will be continuously sold through Panasonic Corporation.

Publisher of this Document is NTCJ.

If you would find description "Panasonic" or "Panasonic semiconductor solutions", please replace it with NTCJ.

※ Except below description page

"Request for your special attention and precautions in using the technical information and semiconductors described in this book"

Nuvoton Technology Corporation Japan

DATA SHEET

Part No.	MN63Y1213
Package Code No.	HS0N008-A-0202

About this manual

■ Organization

These specifications provide important information for users of the MN63Y1213, including an overview and descriptions of functions.

■ Manual Configuration

Each section of this manual consists of a title, main text, and notes. The layout and definition of each section are shown below.

1.1 UART

This section describes the UART specification.

1.1.1 Communication Specifications

Table 1-1 shows the UART specification of this RFID.

Table 1-1 UART Communication Specification

Data transfer method	Asynchronous, half-duplex (Only IRQ notification allows full-duplex)
Data rate	200 bps, 2400 bps, 8000 bps, 9600 bps, 19200 bps, 38400 bps
Character transmission	<ul style="list-style-type: none"> ·LSB-first ·Data (8 bits) ·Start bit (1bit) ·Parity bit (1bit, even) ·Stop bit (1bit) See Note below.
Other	No flow control signal (RTS/CTS)

Note: In order to ensure the timing margin, when sending consecutive data from the host, use a 2-bit stop bit or set the interval between stop bit and next start bit to 1 bit or more.

Middle title

Small title

Text

Note

This is the Note.
Please read.

■ Finding Desired Information

This manual provides two methods for finding desired information quickly and easily.

1. Consult the table of contents at the front of the manual to locate desired titles.
2. Chapter names are located at the top outer corner of each page, and section titles are located at the bottom outer corner of each page.

Chapter 1 Overview

1

Chapter 2 Pin Descriptions

2

Chapter 3 Memory Map

3

Chapter 4 RF Communication Mode

4

Chapter 5 Serial Communication Mode

5

Chapter 6 Interrupt Generation Function

6

Chapter 7 Tunnel Mode

7

Chapter 8 Annex

8

Chapter 9 Electrical characteristics

9

Contents

Chapter 1 Overview	9
1.1 Features.....	10
1.2 Block Diagram.....	11
1.3 Operation Mode.....	12
1.4 Encrypted Communication Function.....	13
Chapter 2 Pin Descriptions	15
2.1 List of Pins.....	16
2.2 Pin Descriptions.....	18
2.3 Connection Example.....	19
Chapter 3 Memory Map.....	21
3.1 Block Configuration	22
3.2 Physical Memory Map.....	23
3.3 System Area.....	24
3.3.1 Parameter Specifications	24
3.3.2 Enabling System Area	31
3.4 Address Correspondence	32
Chapter 4 RF Communication Mode	33
4.1 RF Communication Mode Sequence.....	34
4.2 JISX6319-4 Specification.....	35
4.2.1 Communication Specifications.....	35
4.2.2 Frame Format	35
4.2.3 State Transition Diagram.....	36
4.2.4 Flow Chart.....	36
4.2.5 Various Settings	37
4.2.5.1 System Code	37
4.2.5.2 PICC (Proximity IC Card) Identifier	37
4.2.5.3 Response Time Descriptor	37
4.2.5.4 Anticollision.....	38
4.2.5.5 Service.....	38
4.2.5.6 Block	39
4.2.5.7 Block List.....	41
4.2.5.8 Status Flag.....	43
4.2.6 Command	44
4.2.6.1 REQ.....	45
4.2.6.2 READ.....	46
4.2.6.3 WRITE.....	48
4.2.7 NDEF.....	49

4.2.7.1 MEMORY MAP	49
4.2.7.2 Setup of System Code (SC)	50
4.2.7.3 Setup of Attribute Information Block	50
4.2.7.4 NDEF FILE	51
4.3 ISO/IEC14443 TypeB Specification	52
4.3.1 Communication Specification	52
4.3.2 Frame Format	52
4.3.3 Protocol Control	53
4.3.4 Block Control	55
4.3.5 Upper Command Format	56
4.3.6 State Transition Diagram	57
4.3.7 Flow Chart	58
4.3.8 Various Settings	59
4.3.8.1 AFI (Application Family Identifier)	59
4.3.8.2 PUPI (Pseudo-Unique PICC Identifier)	59
4.3.8.3 FWI (Frame Waiting Time Integer)	60
4.3.8.4 File System	60
4.3.8.5 Address	60
4.3.8.6 Data	62
4.3.8.7 Status Word	63
4.3.9 Command	64
4.3.9.1 REQB/WUPB	65
4.3.9.2 ATTRIB	67
4.3.9.3 HLTB	69
4.3.9.4 SELECT	70
4.3.9.5 READ	72
4.3.9.6 WRITE	73
4.3.10 NDEF	74
4.3.10.1 Memory Map	74
4.3.10.2 NDEF Tag Application Selection	75
4.3.10.3 CC File	75
4.3.10.4 NDEF File	76

Chapter 5 Serial Communication Mode..... 77

5.1 Serial Communication Mode Sequence	78
5.2 I2C	79
5.2.1 Communication Specifications	79
5.2.2 Frame Format	79
5.2.3 Specifying Slave Address	80
5.2.4 Status	80
5.2.5 Command	81
5.2.5.1 READ	82
5.2.5.2 WRITE	83
5.2.5.3 RREG	84
5.2.5.4 WREG	85
5.2.5.5 STATUS	86
5.2.6 Time Chart	87

Chapter 6 Interrupt Generation Function	89
6.1 Interrupt Source	90
Chapter 7 Tunnel Mode	91
7.1 Tunnel Mode Sequence	92
7.2 Communication between Reader/Writer and RFID	93
7.2.1 Using JISX6319-4	93
7.2.2 Using ISO/IEC14443	93
7.3 Communication between Host and RFID	94
7.3.1.1 Communication Specification	94
7.3.1.2 IRQ Notification	94
7.3.2 Response to QUERY Command	95
7.3.3 Timeout	96
7.3.3.1 Wait Time for QUERY Command	97
7.3.3.2 Wait Time for ANSWER Command	98
7.4 Command	99
7.4.1 Read in Tunnel Mode	100
7.4.2 Write in Tunnel Mode	104
Chapter 8 Annex	109
8.1 Exclusive Control	110
8.2 State Transition Diagram in Operation Mode	112
8.3 Flow Chart in Tunnel Mode	113
Chapter 9 Electrical characteristics	115

Chapter 1 Overview



1.1 Features

The MN63Y1213 is an LSI for RFID (Radio Frequency Identification), which features the following:

- Built-in 4-Kbit FeRAM non-volatile memory with fast write and low power consumption.
- RF interface compliant with JISX6319-4 (212 kbps / 424 kbps) and ISO/IEC14443 TypeB (106 kbps / 212 kbps) of the 13.56-MHz contactless IC card standards.
- Serial interface compatible with I2C (100 kHz)
- Batteryless RF communication
- Three communication modes of RF, serial, and tunnel (Tunnel mode allows communications between reader/writer and host CPU via this LSI.)
- Encryption communication function that uses AES (128 bits) private-key cryptosystem
- Supply voltage range: 1.7 V to 3.6 V

1.2 Block Diagram

Figure 1-1 shows a block diagram.

This RFID provides RF interface for contactless communication with external reader/writer, serial interface for contact communication with external host, control logic for command processing and various controls, 2-Kbit transmit/receive buffer for RF communication, 4-Kbit FeRAM non-volatile memory, and AES cryptosystem.

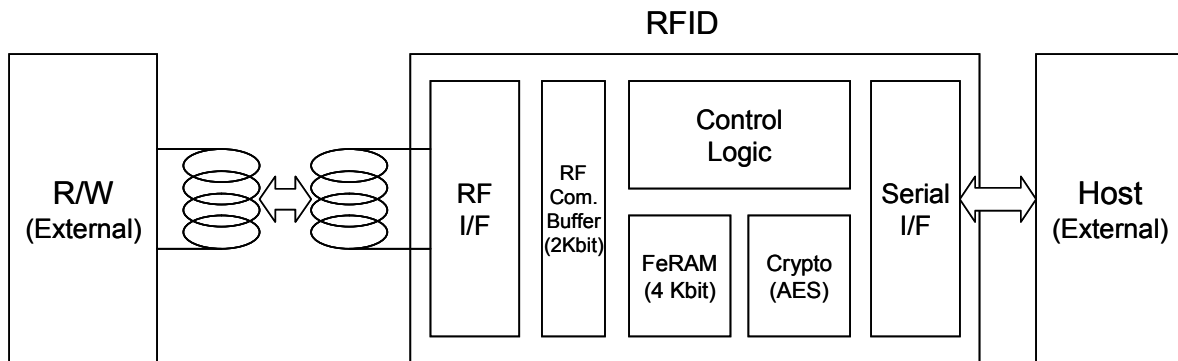

Figure 1-1 Block Diagram

1.3 Operation Mode

This RFID provides three operation modes of RF communication, serial communication, and tunnel.

Figure 1-2 gives the overview of each operation mode.

■ RF communication mode

This mode is used for communication between reader/writer and RFID. Reader/writer is the master and RFID is the slave. Key commands are read and write commands to FeRAM of RFID. This mode allows batteryless operations that use only the power supplied from the antenna of reader/writer.

For more information about RF communication mode, see Chapter 4 RF Communication Mode.

■ Serial communication mode

This mode is used for communication between host and RFID. Host is the master and RFID is the slave. Key commands are read and write commands to FeRAM of RFID. This mode requires a power supply to the supply voltage pin (VDDEX) of RFID.

For more information about serial communication mode, see Chapter 5 Serial Communication Mode.

■ Tunnel mode

This mode is used for communication between reader/writer and host via RFID. Reader/writer is the master and host is the slave. Key commands are read and write commands to host. This mode requires a power supply to the supply voltage pin (VDDEX) of RFID.

For more information about serial communication mode, see Chapter 7 Tunnel Mode.

Additionally, for state transition diagram in each operation mode, see Section 8.2 State Transition Diagram in Operation Mode.

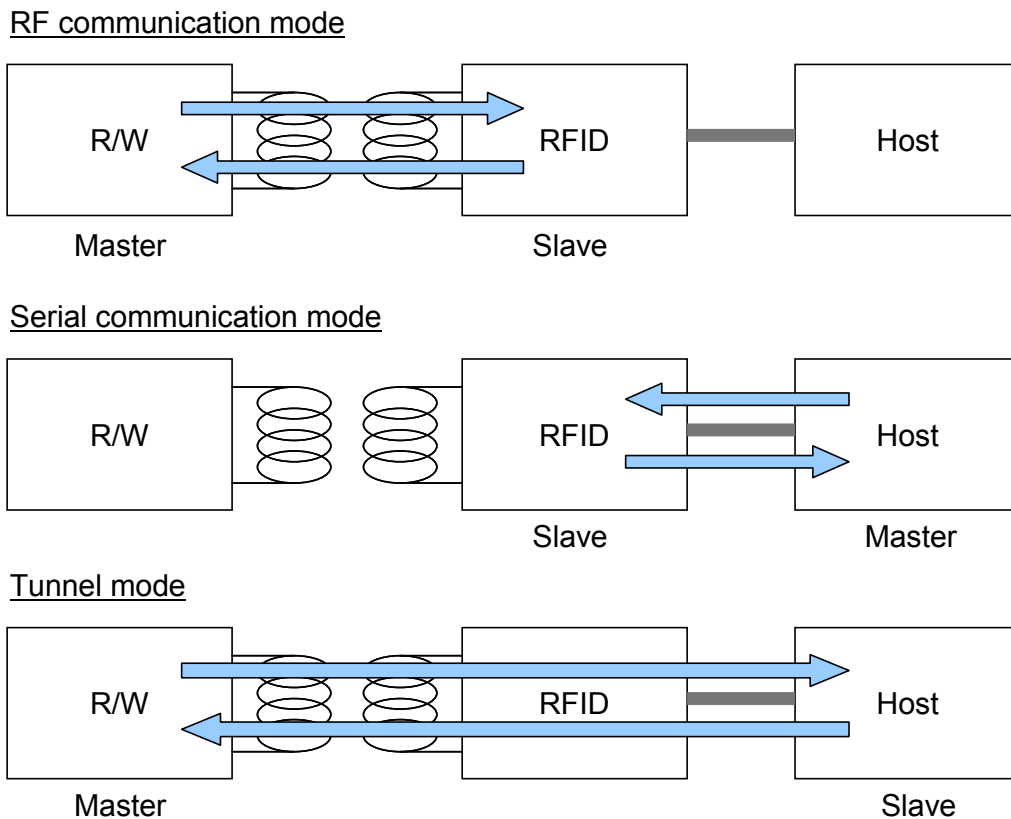

Figure 1-2 Operation Mode

1.4 Encrypted Communication Function

This RFID provides an encrypted communication function.

Figure 1-3 depicts its functionality in each operation mode.

For communication between reader/writer and RFID, RF communication mode allows both encrypted and plaintext (unencrypted) communications while serial communication mode allows only plaintext communication.

Tunnel mode enables both encrypted and plaintext communications between reader/writer and RFID. However, for communication between RFID and host, the mode enables only plaintext communication, regardless of communication form (encrypted or plaintext) between reader/writer and RFID.

Encrypted communication uses Message Authentication Code (MAC) to detect falsified communication data and to prevent access from illegal readers/writers.

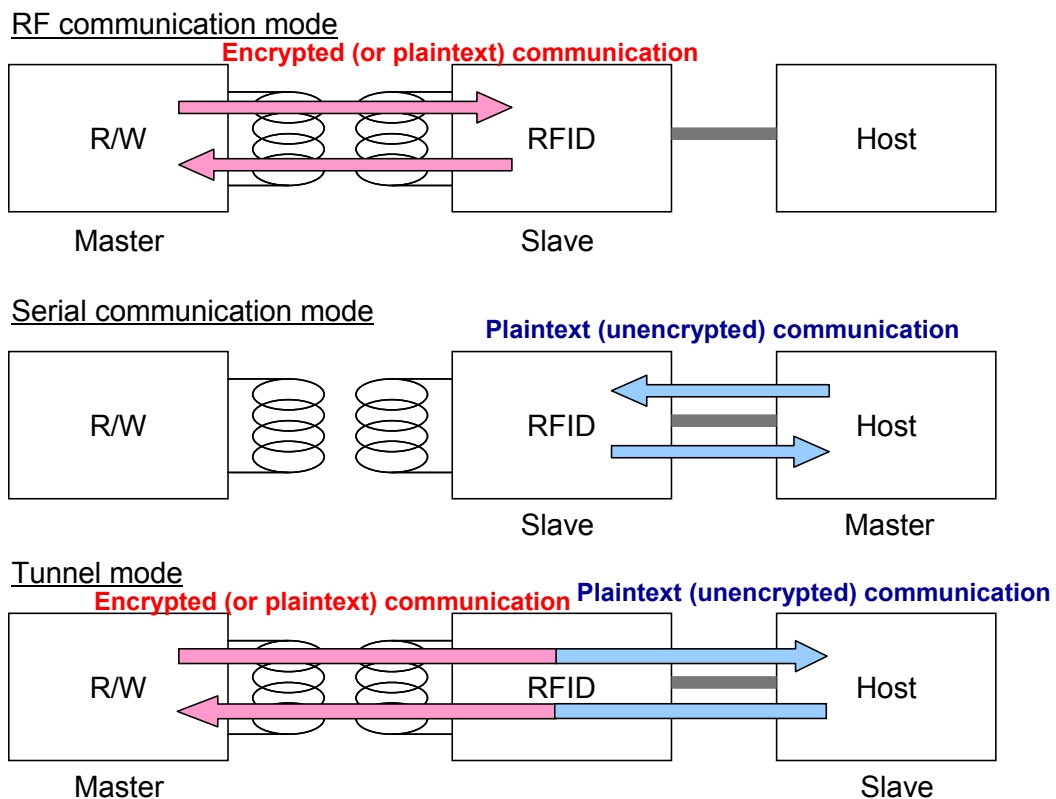

Figure 1-3 Encrypted Communication Function

Chapter 2 Pin Descriptions

2.1 List of Pins

Table 2-1 shows a list of pins of this RFID and Figure 2-1 illustrates the pin assignments of this RFID.

Table 2-1 List of Pins

Pin No.	Name	I/O	Output type	Description
1	VB	I/O	-	Connected to coil
2	VDDEX	-	Power	Contact power supply (Apply 1.7 V through 3.6 V.)
3	VSS	-	GND	Ground
4	VA	I/O	-	Connected to coil
5	NIRQ	Output	Open Drain	Interrupt request output
6	SCL	Input	-	Host interface (I2C: 100 kHz)
7	SDA	I/O	Open Drain	Host interface (I2C: 100 kHz)
8	VDDA	-	Power	Internal analog power supply (Connect a capacitor between this pin and VSS.)

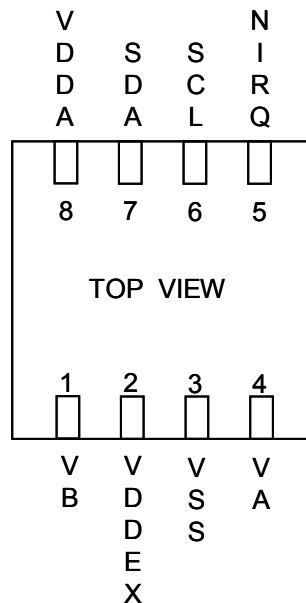
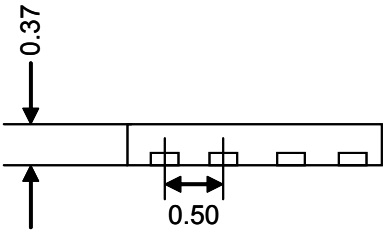
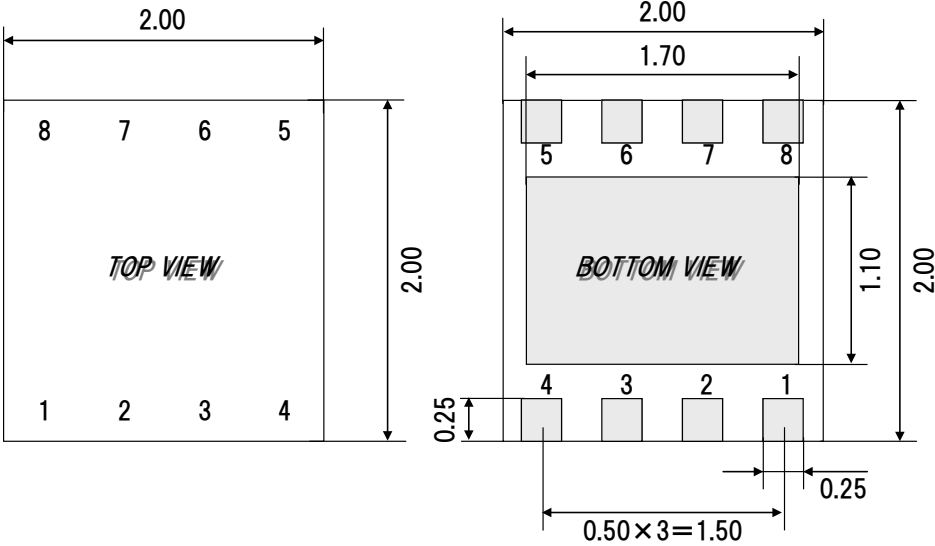

Figure 2-1 Pin Assignments (SON8)



Unit : mm

Figure 2-2 Outside drawing (SON8)

2.2 Pin Descriptions

■ Coil connection pins (VA, VB)

Used for connecting an antenna coil. Also connect a resonance capacitor for adjusting resonance frequency.

■ Ground (VSS)

A reference power supply pin. Connect to the ground of the host CPU.

■ Internal analog power supply (VDDA)

An internal analog power supply pin. Connect a capacitor (see the Product Standards for its value) between VDDA and VSS pins as close as possible to the RFID. It is unnecessary to apply an external power to this pin.

■ Contact power supply (VDDEX)

A contact power supply pin. Apply a "high" voltage to this pin when communicating data between the host CPU and RFID. Connect a capacitor (see the Product Standards for its value) between VDDEX and VSS pins as close as possible to the RFID.

Additionally, the RFID has a built-in clamp circuit for 5-V operation. When using the circuit, apply a 5-V supply voltage to this pin through a given resistor (see the Product Standards for its value).

■ Host interface I2C (SDA, SCL)

I2C is an N-ch open drain pin, so should be pulled up to VDDEX externally. It is available between the frequencies 20 kHz and 100 kHz. Start the access t_{Boot} after applying VDDEX. For more information about t_{Boot} , see the Product Standards.

■ Interrupt request (NIQR)

An N-ch open drain pin to request an interrupt to the host and should be pulled up externally.

2.3 Connection Example

Figure 2-3 gives a connection example.

This example shows that the host's GPIO controls the RFID's VDDEX. In this case, when not using serial communication, turning VDDEX off allows the consumption current of the RFID to be turned off. In addition, it is also possible to supply a voltage to VDDEX directly from the power supply, not from the host's GPIO.

The SDA(IO) and NIRQ pins are open-drain output. Pull up these pins to the same voltage level as the power supply of the host.

Please arrange the capacity between power supplies of VDDA near the PKG as much as possible.

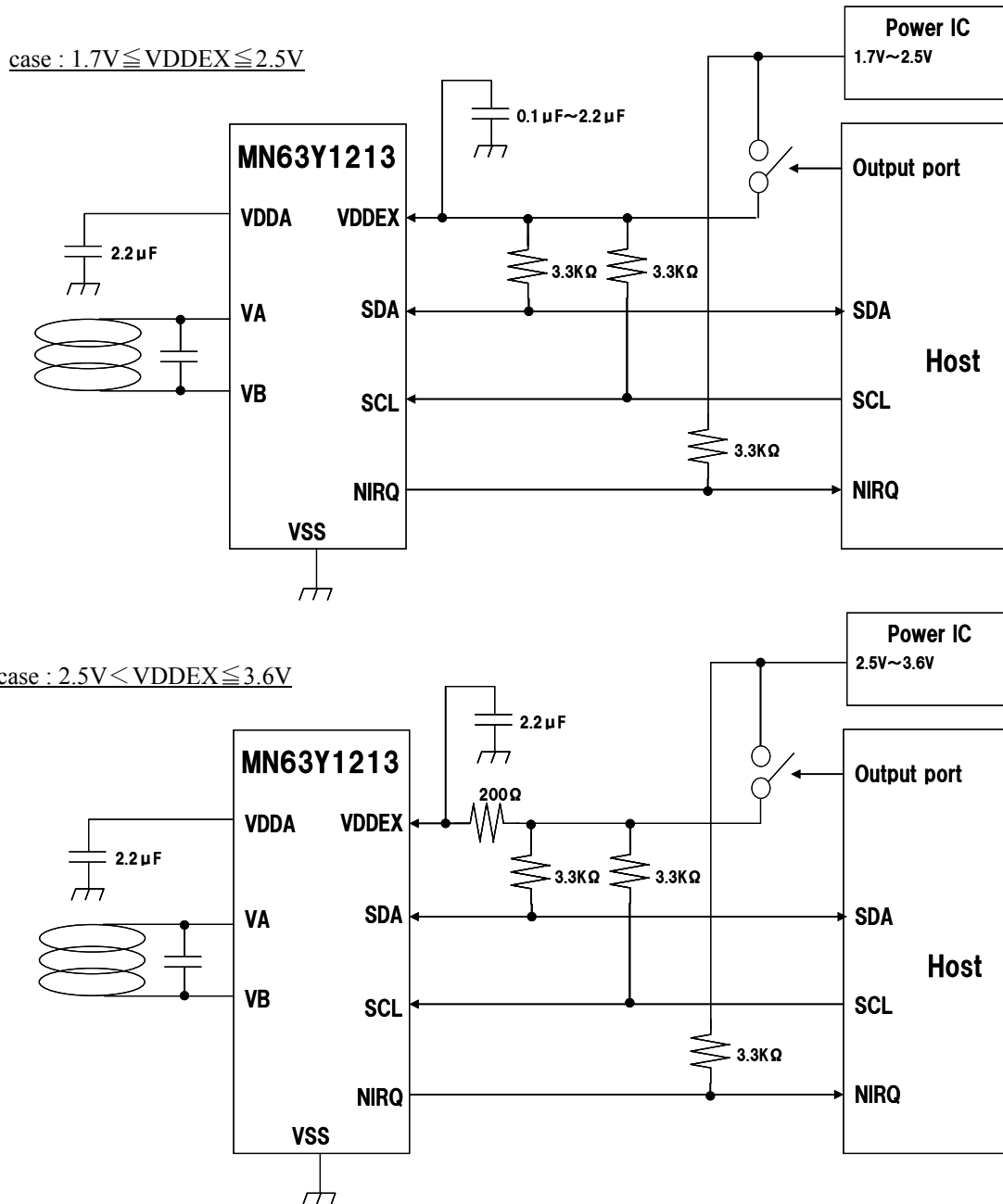

Figure 2-3 Connection Example

Chapter 3 Memory Map

3.1 Block Configuration

Figure 3-1 illustrates the block configuration of 4-Kbit FeRAM.

This LSI consists of 32 FeRAM blocks. The size of a block is 16 bytes.

The memory consists of two areas: user and system areas.

The system area stores RF-communication-related parameters and memory-access-control-related data, etc.

Block	Area	Type
0	16-byte FeRAM	User area
1	16-byte FeRAM	
2	16-byte FeRAM	
3	16-byte FeRAM	
...	...	
24	16-byte FeRAM	
25	16-byte FeRAM	
26	16-byte FeRAM	
27	16-byte FeRAM	
28	16-byte FeRAM	
29	16-byte FeRAM	System area
30	16-byte FeRAM	
31	16-byte FeRAM	

Figure 3-1 4-Kbit FeRAM Block Configuration

3.2 Physical Memory Map

Figure 3-2 presents the physical memory map.

Block	Address	0x0	0x1	0x2	0x3	0x4	0x5	0x6	0x7	0x8	0x9	0xA	0xB	0xC	0xD	0xE	0xF
0	0x0000	User Area															
1	0x0010	User Area															
2	0x0020	User Area															
3	0x0030	User Area															
4	0x0040	User Area															
5	0x0050	User Area															
6	0x0060	User Area															
7	0x0070	User Area															
8	0x0080	User Area															
9	0x0090	User Area															
10	0x00A0	User Area															
11	0x00B0	User Area															
12	0x00C0	User Area															
13	0x00D0	User Area															
14	0x00E0	User Area															
15	0x00F0	User Area															
16	0x0100	User Area															
17	0x0110	User Area															
18	0x0120	User Area															
19	0x0130	User Area															
20	0x0140	User Area															
21	0x0150	User Area															
22	0x0160	User Area															
23	0x0170	User Area															
24	0x0180	User Area															
25	0x0190	User Area															
26	0x01A0	User Area															
27	0x01B0	CONFIG															
28	0x01C0	CONFIG															
29	0x01D0	CONFIG															
30	0x01E0	SC	IDM						PMM	AFI	FWI	HW1					
31	0x01F0	RORF				ROSI				SECURITY				TNPRM	HW2	CONFIG	

Figure 3-2 Physical Memory Map

3.3 System Area

This section describes the system area.

3.3.1 Parameter Specifications

Each parameter of the system area is shown below.

All addresses and block numbers used in this section correspond to the physical address in Figure 3-2.

■ RORF (4 bytes)

RORF and SECURITY are an area to specify whether read/write or read-only is to be used in accessing the block by memory access commands in RF communication mode. Tabel 3-1 describes RORF and SECURITY setting, and shows RORF setting bits and corresponding block numbers. By default, all values are 0. Set all reserved bits to 0.

Tabel 3-1 RORF and SECURITY Setting

Value		Meaning -	
SECURITY	RORF	Plaintext communication	Encryption communication
0	0	READ/WRITE	READ/WRITE
0	1	Prohibition	READ/WRITE
1	0	READ ONLY	READ ONLY
1	1	READ ONLY	READ/WRITE

Tabel 3-2 RORF Setting Bits and Corresponding Block Numbers

Address	Bit 7	Bit 6	Bit 5	Bit 4	Bit 3	Bit 2	Bit 1	Bit 0
0x01F0	Block7	Block6	Block5	Block4	Block3	Block2	Block1	Block0
0x01F1	Block15	Block14	Block13	Block12	Block11	Block10	Block9	Block8
0x01F2	Block23	Block22	Block21	Block20	Block19	Block18	Block17	Block16
0x01F3	Reserved	Reserved	Reserved	Reserved	Reserved	Block26	Block25	Block24

■ ROSI (4 bytes)

ROSI is an area to specify whether read/write or read-only is to be used in accessing the block by memory access commands in serial communication mode. Table 3-1 describes ROSI setting, and Table 3-2 shows ROSI setting bits and corresponding block numbers. By default, all values are 0. Set all reserved bits to 0.

Table 3-1 ROSI Setting

Value	Meaning
0	Read/Write
1	Read only

Table 3-2 ROSI Setting Bits and Corresponding Block Numbers

Address	Bit 7	Bit 6	Bit 5	Bit 4	Bit 3	Bit 2	Bit 1	Bit 0
0x01F4	Block7	Block6	Block5	Block4	Block3	Block2	Block1	Block0
0x01F5	Block15	Block14	Block13	Block12	Block11	Block10	Block9	Block8
0x01F6	Block23	Block22	Block21	Block20	Block19	Block18	Block17	Block16
0x01F7	Reserved	Reserved	Reserved	Reserved	Reserved	Block26	Block25	Block24

■ SECURITY (4 bytes)

RORF and SECURITY are an area to specify whether to enable plaintext (unencrypted) communication access by memory access commands in RF communication mode. This setting is valid only in RF communication mode.

Table 3-5 describes RORF and SECURITY setting, and Table 3-5 shows SECURITY setting bits and corresponding block numbers. By default, all values are 0. Set all reserved bits to 0.

Table 3-5 SECURITY Setting Bit and Corresponding Block Number

Address	Bit 7	Bit 6	Bit 5	Bit 4	Bit 3	Bit 2	Bit 1	Bit 0
0x01F8	Block7	Block6	Block5	Block4	Block3	Block2	Block1	Block0
0x01F9	Block15	Block14	Block13	Block12	Block11	Block10	Block9	Block8
0x01FA	Block23	Block22	Block21	Block20	Block19	Block18	Block17	Block16
0x01FB	Reserved	Reserved	Reserved	Reserved	Reserved	Block26	Block25	Block24

■ HW1 (2 bytes)

HW1 is an area to store various setting data related to the hardware of this RFID.

Table 3-6 describes the HW1 parameter. For the setting of the RF communication protocol RFTYPE, see Table 3-7. For the setting of IDM data selection IDMSEL, see Table 3-8. For the setting of the I2C slave address setting I2C_SLV, see Table 3-9.

Table 3-6 HW1 Parameter

Address	Bit 7	Bit 6	Bit 5	Bit 4	Bit 3	Bit 2	Bit 1	Bit 0
0x01EE	Reserved		RFTYPE		Reserved			IDMSEL
0x01EF	Reserved	I2C_SLV						

Table 3-7 RFTYPE Setting for Selecting RF Communication Protocol

Bit 5	Bit 4	Meaning
0	0	Use both JISX6319-4 and ISO/IEC14443 TypeB. (Automatic protocol detection) (default)
0	1	Use JISX6319-4 only. (ISO/IEC14443 TypeB interface disabled)
1	0	Use ISO/IEC14443 TypeB only. (JISX6319-4 interface disabled)
1	1	Reserved (When this field is specified, a default setting will be applied.)

Table 3-8 IDMSEL Setting for Selecting IDM Data

Bit 0	Meaning
0	Use the fixed values (All-0) as JISX6319-4 PICC identifier or ISO/IEC14443 TypeB PICC. Values written in the system area are not used. (default)
1	Use the values written in the system area as JISX6319-4 PICC identifier or ISO/IEC14443 TypeB PICC.

Table 3-9 I2C_SLV Setting for Specifying I2C Slave Address

Address	Bit 6	Bit 5	Bit 4	Bit 3	Bit 2	Bit 1	Bit 0
Default value	1	0	1	0	1	0	0

■ TNPRM (1 byte)

TNPRM is an area to store various setting data related to timeout.

For more information about this parameter, see Section 7.3.3 Timeout.

Table 3-10 describes the TNPRM parameter.

Table 3-10 TNPRM Parameter

Address	Bit 7	Bit 6	Bit 5	Bit 4	Bit 3	Bit 2	Bit 1	Bit 0
0x01FC	QWT				AWT			

■ QWT

QWT specifies the maximum wait time until the RFID receives a QUERY command from the host after it sends an IRQ to the host during tunnel mode operation.

QWT is determined using the following formula.

$$\text{Maximum wait time for QUERY command} = T \times 2^{\text{QWT}}$$

T: Typ. 1024 μs (±25%)

QWT: 0 to 8 (default: 4; typ. approximately 16 ms)

When this field is set to a value other than 0 to 8, a default value will be applied.

■ AWT

AWT specifies the maximum wait time until the RFID receives an ANSWER command from the host after it sends a response to the QUERY command to the host during tunnel mode operation.

AWT is determined using the following formula.

$$\text{Maximum wait time for ANSWER command} = T \times 2^{\text{AWT}}$$

T: typ. 1024 μs (±25%)

AWT: 0 to 12 (default: 7; typ. approximately 131 ms)

When this field is set to a value other than 0 to 12, a default value will be applied.

Note: T includes an error of ±25%. Set the QWT and AWT values in consideration of the error.

■ HW2 (1 byte)

HW2 is an area to store various setting data related to the hardware of this RFID.

Table 3-11 describes the HW2 parameter. INTWT and RESWT are parameters related to timeout in I2C communication. For the setting of IRQSEL for IRQ notification, see Table 3-12.

Table 3-11 HW2 Parameter

Address	Bit 7	Bit 6	Bit 5	Bit 4	Bit 3	Bit 2	Bit 1	Bit 0
0x01FC	INTWT		RESWT		Reserved	IRQSEL		

■ INTWT

INTWT specifies the maximum wait time between characters in I2C communication.

INTWT is determined using the following formula.

$$\text{Maximum wait time between characters} = T \times 2^{\text{INTWT}}$$

T: Typ. 942 μs (±25%)

INTWT: 0 to 3 (default: 3; typ. approximately 7.5ms)

When this field is set to a value other than 0 to 8, a default value will be applied.

■ RESWT

RESWT specifies the maximum wait time from the start of response to the command (NIRQ = L) until slave transmission request input in I2C communication.

RESWT is determined using the following formula.

$$\text{Maximum wait time for starting response} = T \times 2^{\text{RESWT}}$$

T: Typ. 1.88ms(±25%)

RESWT: 0 to 3: (default: 3, typ. approximately 15 ms)

When this field is set to a value other than 0 to 12, a default value will be applied.

Note: T includes an error of ±25%. Set the INTWT and RESWT values in consideration of the error.

■ IRQSEL

IRQSEL is used for IRQ notification to add the condition of generating an interrupt to the NIRQ pin.

Setting IRQSEL allows an additional interrupt to be generated in addition to a normal host command processing complete interrupt.

There are two user-selectable additional interrupt sources, RF communication detection or reader/writer magnetic-field detection. In addition, RF communication detection is selected from FeRAM write completion by RF command and RF response before sending.

For more information about interrupt source, see Chapter 6 Interrupt Generation Function.

The IRQSEL settings are as follows.

Table 3-12 IRQSEL Setting for IRQ Notification

Bit 2	Bit 1	Bit 0	Meaning
0	0	X	Do not generate an interrupt when RF response before transmission or when a write to FeRAM with the RF command is completed.
0	1	X	Reserved
1	0	X	Generate an interrupt when RF response before transmission.
1	1	X	Generate an interrupt when a write to FeRAM with the RF command is completed.
X	X	0	Do not generate an interrupt when a magnetic field is detected.
X	X	1	Generate an interrupt when a magnetic field is detected.

By default, value of each bit of IRQSEL is 0.

■ SC (2 bytes)

SC is used as the JISX6319-4 system code (2 bytes). For more information about system code, see Section 4.2.5.1 System Code.

Table 3-13 SC Parameter

Address	0x01E0	0x01E1
JISX6319-4 system code (2 bytes)	D0	D1
Default	0xAA	0xFF

■ IDM (8 bytes)

IDM is used as JISX6319-4 PICC (Proximity IC Card) identifier (8 bytes). The PUPI (Pseudo-Unique PICC Identifier) (4 bytes) of ISO/IEC14443 TypeB is shared with the lower 4 bytes of the JISX6319-4 PICC identifier. For information about JISX6319-4 PICC identifier, see Section 4.2.5.2 PICC (Proximity IC Card) Identifier, and for information about ISO/IEC14443 TypeB PUPI, see Section 4.3.8.2 PUPI.

Table 3-14 IDM Parameter

Address	0x01E2	0x01E3	0x01E4	0x01E5	0x01E6	0x1E7	0x1E8	0x01E9
JISX6319-4 PICC identifier (8 bytes)	D0	D1	D2	D3	D4	D5	D6	D7
Default	0x02	0xFE	0x00	0x00	0x00	0x00	0x00	0x00
ISO/IEC14443TypeB PUPI (4 bytes)	Reserved				D0	D1	D2	D3
Default	-	-	-	-	0x00	0x00	0x00	0x00

Note: In order to validate the value written in the system area IDM, the HW parameter's IDMSEL must be set to 1. See Table 3-8.

■ PMM (2 bytes)

Of the JISX6319-4 response time descriptor (8 bytes), PMM is an area (2 bytes) to specify maximum wait time for the response to READ/WRITE commands. See Section 4.2.5.3 .

Table 3-15 PMM Parameter

Address	0x01EA	0x01EB
JISX6319-4 Response time descriptor (2 bytes)	D5	D6
Default	0xFF	0xFF

■ AFI (1 byte)

AFI is an area to specify AFI (Application Family Identifier) of ISO/IEC14443 TypeB. See Section 4.3.8.1 AFI.

Table 3-16 AFI Parameter

Address	0x01EC
ISO/IEC14443 TypeB AFI (1 byte)	D0
Default	0x00

■ FWI (1 byte)

FWI is an area to specify FWI (Frame Waiting time Integer) of ISO/IEC14443 TypeB. See Section 4.3.8.3 FWI.

Table 3-17 FWI Parameter

Address	0x01ED
ISO/IEC14443 TypeB FWI (1 byte)	D0
Default	0xE0

■ CONFIG

See the Administrator's Manual.

3.3.2 Enabling System Area

In order to enable parameters in the system area, CFEN and BCC (see the Administrator's Manual) of the system area must be set to valid values. If CFEN and BCC are not set to valid values, default values defined by each parameter will be applied.

Table 3-18 lists the setting application timings after rewriting parameters in the system area while CFEN and BCC are enabled. New parameter setting is applied to RORF, ROSI, and SECURITY immediately after rewriting, and applied to other parameters after turning power supply ON from OFF or applied to other parameters after the self-reset by the WREG command of the serial communication.

Table 3-18 Parameter Application Timing

	A timing at which new parameter setting is applied after rewriting parameters when CFEN is enabled.
RORF	Apply immediately after rewrites.
ROSI	Apply immediately after rewrites.
SECURITY	Apply immediately after rewrites.
HW1	Apply after turning power ON from OFF following rewrites.
TNPRM	Apply after turning power ON from OFF following rewrites.
HW2	Apply after turning power ON from OFF following rewrites.
SC	Apply after turning power ON from OFF following rewrites.
IDM	Apply after turning power ON from OFF following rewrites.
PMM	Apply after turning power ON from OFF following rewrites.
AFI	Apply after turning power ON from OFF following rewrites.
FWI	Apply after turning power ON from OFF following rewrites.
CONFIG	See the Administrator's Manual.

Note: Power OFF means power supplies from both VDDEX and RF interface are OFF.

3.4 Address Correspondence

Figure 3-3 presents the physical address and the corresponding address of each communication mode.

Physical address		Serial communication mode	RF communication mode		
			JISX6319-4		ISO/IEC14443
Block0	0x0000	0x0000	Block No. 0	D0	0x0000
	0x0001	0x0001		D1	0x0001
	0x0002	0x0002		D2	0x0002
	0x0003	0x0003		D3	0x0003
	0x0004	0x0004		D4	0x0004
	0x0005	0x0005		D5	0x0005
	0x0006	0x0006		D6	0x0006
	0x0007	0x0007		D7	0x0007
	0x0008	0x0008		D8	0x0008
	0x0009	0x0009		D9	0x0009
	0x000A	0x000A		Da	0x000A
	0x000B	0x000B		Db	0x000B
	0x000C	0x000C		Dc	0x000C
	0x000D	0x000D		Dd	0x000D
	0x000E	0x000E		De	0x000E
	0x000F	0x000F		Df	0x000F
Block1	0x0010	0x0010	Block No. 1	D0	0x0010
	0x0011	0x0011		D1	0x0011

	0x001E	0x001E		De	0x001E
	0x001F	0x001F		Df	0x001F
...					
Block31	0x01F0	0x01F0	Block No. 31	D0	0x01F0
	0x01F1	0x01F1		D1	0x01F1

	0x01FE	0x01FE		De	0x01FE
	0x01FF	0x01FF		Df	0x01FF

Figure 3-3 Address Correspondence

Chapter 4 RF Communication Mode

4.1 RF Communication Mode Sequence

Figure 4-1 illustrates the sequence in RF communication mode. Each sequence is described below.

SNo.1: A reader/writer sends an RF communication mode command to the RFID.

SNo.2: Once the RFID receives the RF communication mode command described in SNo.1, it processes the command and then sends the result to the reader/writer as the response to the command.

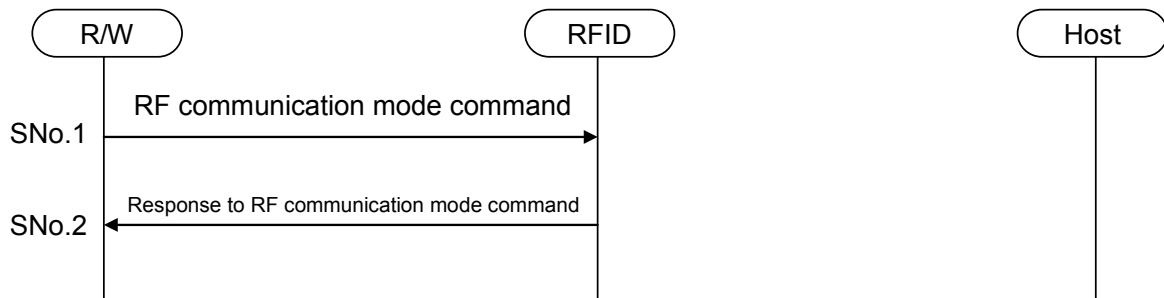

Figure 4-1 RF Communication Mode Sequence

4.2 JISX6319-4 Specification

This section describes the JISX6319-4 specification of this RFID.

4.2.1 Communication Specifications

Table 4-1 shows the JISX6319-4 specification of this RFID.

Table 4-1 JISX6319-4 Communication Specification

Carrier frequency		13.56 MHz
Modulation mode, Bit encoding	R/W→RFID	ASK10%, Manchester encoding
	RFID→R/W	Load modulation, Manchester encoding
Data rate		212 kbps / 424 kbps
Character transmission		<ul style="list-style-type: none"> • MSB-first • Data (8 bits) • No start bit • No parity bit • No stop bit • No spare time between characters

4.2.2 Frame Format

Figure 4-2 illustrates the JISX6319-4 frame format and Table 4-2 defines the fields.

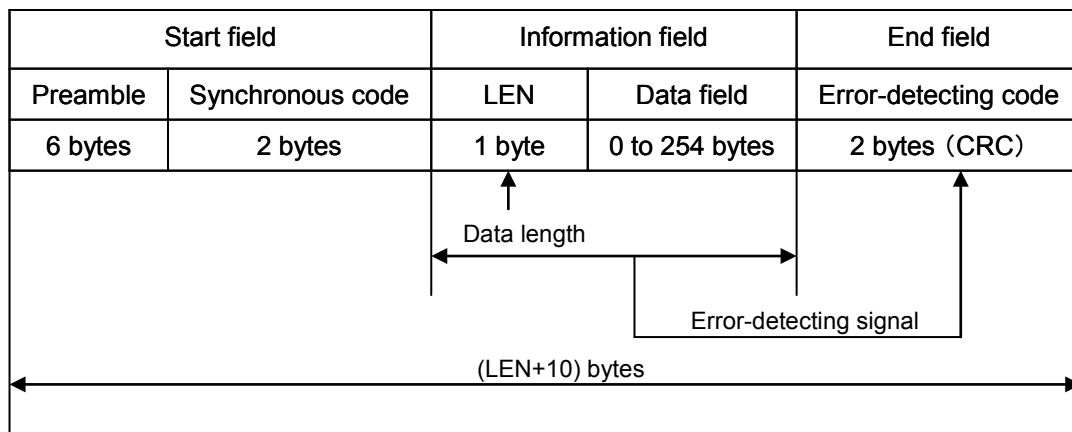

Figure 4-2 JISX6319-4 Frame Format

Table 4-2 JISX6319-4 Field Definition

Field name	Byte length	Definition
Preamble	6	0x000000000000
Synchronous code	2	0xB24D
LEN	1	n (data field length) + 1
Data field	n	Command message or Response message
Error-detecting code	2	Initial value: 0000, Generating polynomial: CRC of $X^{16}+X^{12}+X^5+1$

4.2.3 State Transition Diagram

Figure 4-3 shows the state transition diagram for the JIX6319-4 PICC of this RFID.

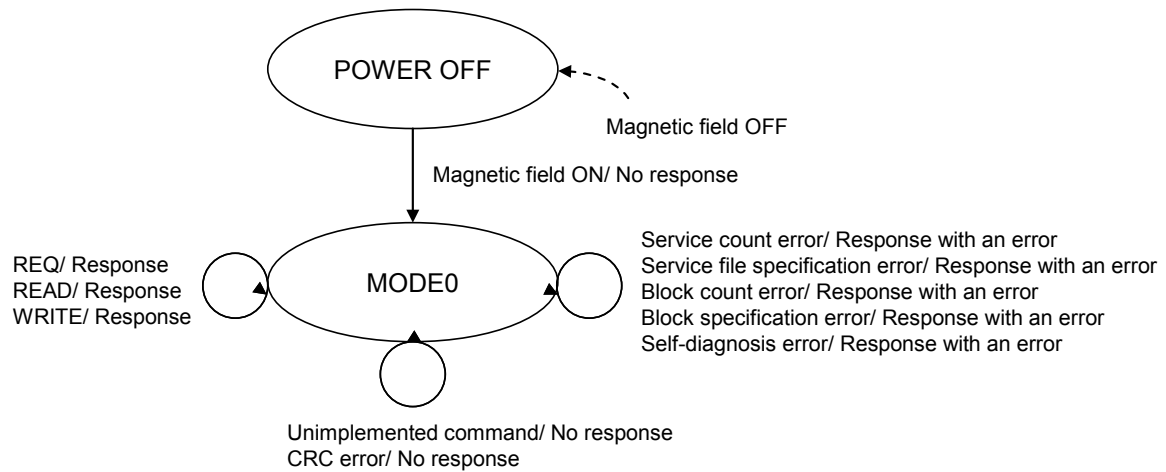

Figure 4-3 State Transition Diagram of JISX6319-4 PICC

4.2.4 Flow Chart

Figure 4-4 gives the flow chart for JIX6319-4 command processing of this RFID.

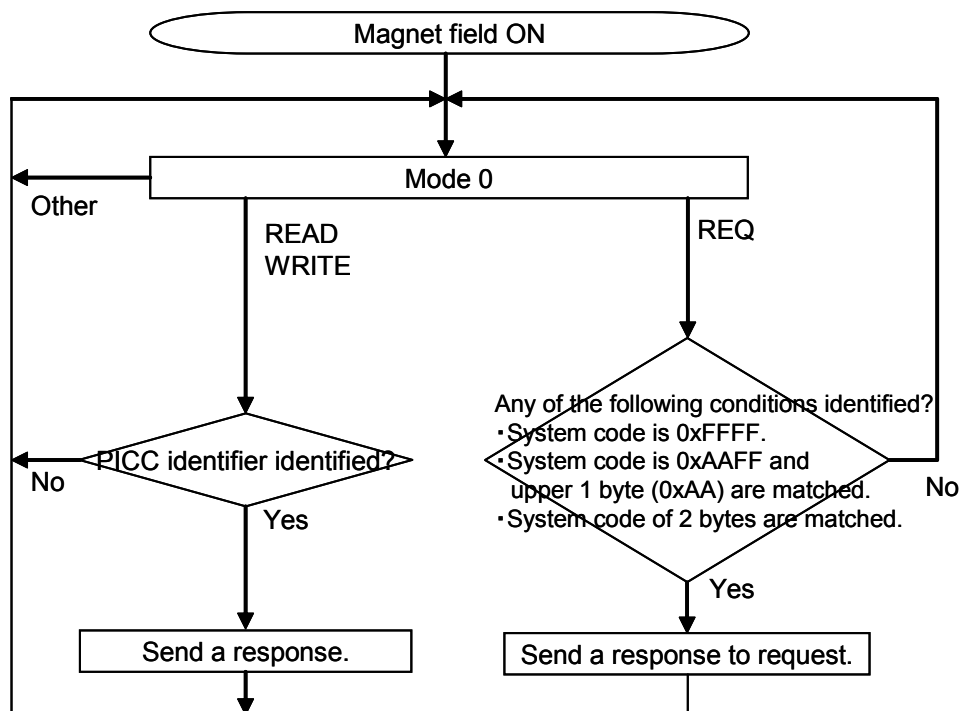

Figure 4-4 JISX6319-4 Flow Chart of Command Processing

4.2.5 Various Settings

This section describes the parameter settings and operation specifications based on JISX6319-4 for this RFID.

4.2.5.1 System Code

System code is a parameter specified by the REQ command that is used to identify the RFID. Figure 4-5 shows the system code. The system code is set by the value of the system area SC for FeRAM.

The response operation to the REQ command by system code is shown in Table 4-3.

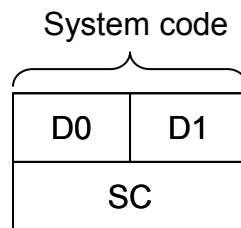

Figure 4-5 System Code

Table 4-3 Response to REQ Command by System Code

REQ command System code setting value	RFID's response to REQ command
0xFFFF	Responds regardless of the system area SC setting
0xA AFF	When the value of the upper 1 byte of the SC system area is 0xAA, the RFID responds regardless of the value of the lower 1 byte.
Other	Responds only when the setting value of the REQ command's system code matches the value specified in the system area SC (and does not respond in other cases).

4.2.5.2 PICC (Proximity IC Card) Identifier

The PICC (Proximity IC Card) identifier is a data used to identify RFID, and is included in the response to the REQ command. Figure 4-6 illustrates the PICC identifier's format. The PICC identifier (8 bytes) is set in the system area IDM.

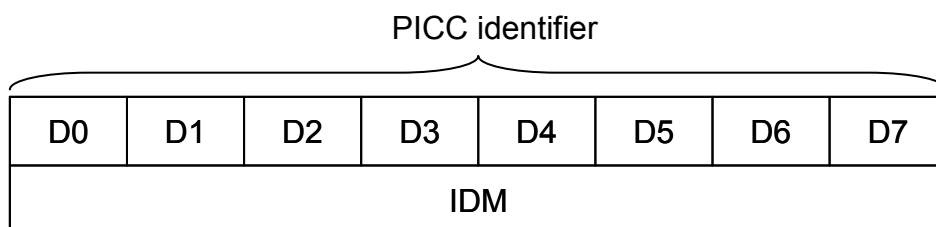

Figure 4-6 PICC Identifier Format

4.2.5.3 Response Time Descriptor

The response time descriptor is used to specify the maximum wait time until the RFID sends a response after reader/writer sends a command, and is included in the response to the REQ command. Figure 4-7 illustrates

the response time descriptor's format. In hardware, D0, D1, and D7 bytes are set to FFh and D2 to D4 bytes are set to 00h. The response time calculation parameters D5 and D6 bytes are the values of the system area. Table 4-4 shows the response time calculation parameter and corresponding command.

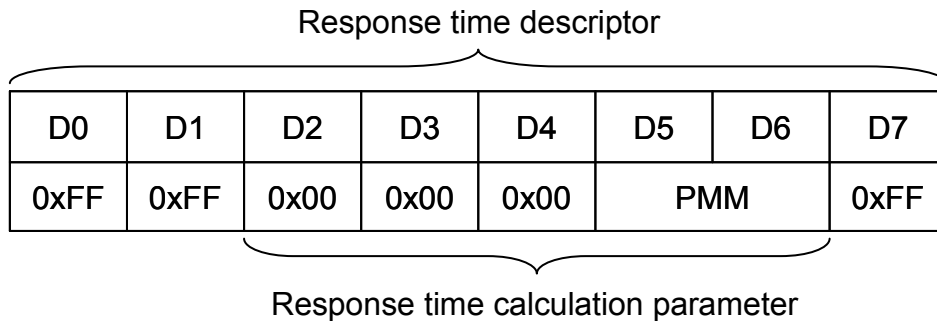

Figure 4-7 Response Time Descriptor Format

Table 4-4 Response Time Calculation Parameter and Corresponding Command

Response time calculation parameter	Command
D5	READ
D6	WRITE

Figure 4-8 shows the response time calculation parameter's format.

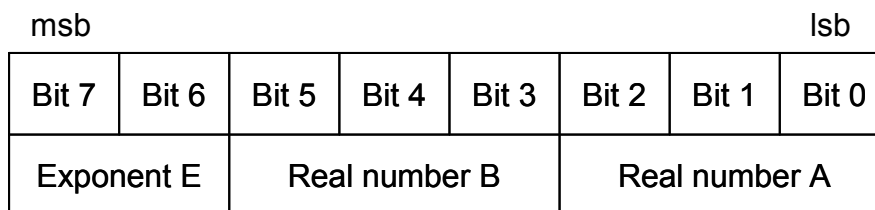

Figure 4-8 Response Time Calculation Parameter Format

The response time is calculated by the following formula:

$$\text{Response time} = T \times [(B + 1) \times n + (A + 1)] \times 4^E$$

T: $256 \times 16/f_c$ (approx. 0.302 ms)

n: No. of blocks or No. of files of command parameter.

4.2.5.4 Anticollision

JISX6319-4 uses the time slot method for anti-collision (prevention of collision). This RFID always responds according to the first slot.

4.2.5.5 Service

This RFID does not implement the concept of service based on JISX6319-4.

However, it is possible to specify multiple services using a command service list. Table 4-5 shows the available maximum number of services. When specifying multiple services in the service list, the values of service list must be set to the same value.

Table 4-5 Maximum Number of Services

Command	Maximum No. of services
READ	15
WRITE	11

Note: The RFID responds with an error when multiple services are not set to the same service file value.

4.2.5.6 Block

JISX6319-4 uses data of 16-byte blocks. Block number is used to specify each block. Figure 4-9 shows the block element of 2 bytes and Figure 4-10 shows the block element of 3 bytes. All of bits 6 to 4 of byte D0 for access mode setting should be set to 0 in this RFID; otherwise the RFID responds with an error.

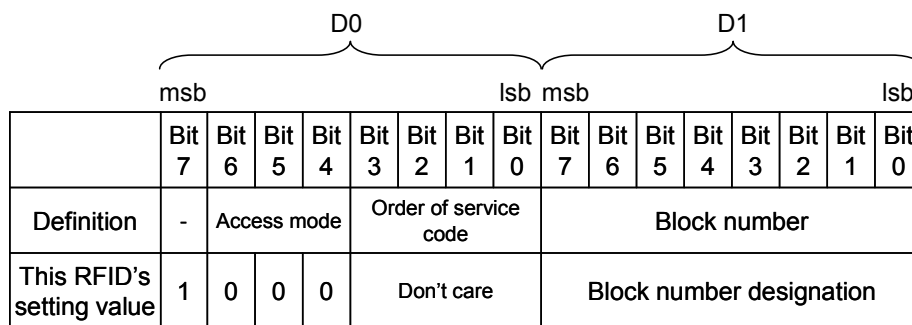

Figure 4-9 Block Element of 2 Bytes

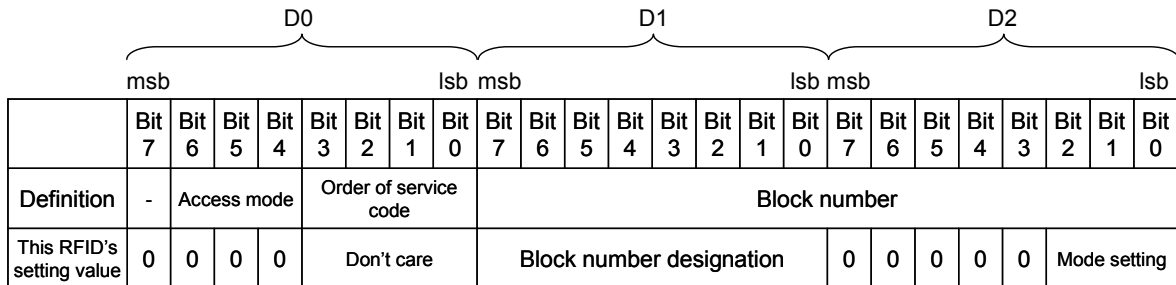

Figure 4-10 Block Element of 3 Bytes

This RFID uses a block number to specify tunnel mode and encrypted communication. Table 4-6 shows the mode settings for tunnel mode and encrypted communication. Bits 2 to 0 of byte D2 in 3-byte block element format are used. All of bits 7 to 3 of byte D2 should be set to 0; otherwise the RFID responds with an error.

Table 4-6 Mode Settings

Block element format	Byte D2 of block No.			Meaning	
	Bit 2	Bit 1	Bit 0	Communication mode	Encrypted communication
2 bytes	-	-	-		
3 bytes	0	0	0	RF communication mode	Plaintext (unencrypted) communication
	0	1	0		Encrypted communication (private key)
	0	1	1		Encrypted communication (family key)
	0	0	1	Reserved (Setting this field causes an error.)	
	1	0	0	Tunnel mode	Plaintext (unencrypted) communication
	1	1	0		Encrypted communication (private key)
	1	1	1		Encrypted communication (family key)
	1	0	1	Reserved (Setting this field causes an error.)	

Table 4-7 shows the available maximum number of blocks. For READ command, the number is 15 for plaintext (unencrypted) communication in RF communication mode. The maximum number of blocks for WRITE command depends on the number of services.

Table 4-7 Maximum Number of Blocks

Command	Communication mode	Encrypted communication	No. of services	Maximum No. of blocks
READ	RF communication mode	Plaintext (unencrypted) communication	1 to 15	15
		Encrypted communication	1 to 15	15
Tunnel mode	Plaintext (unencrypted) communication, Encrypted communication			
WRITE	RF communication mode, Tunnel mode	Plaintext (unencrypted) communication, Encrypted communication	1 to 8	12
			9 to 11	11

Note: Encrypted communication uses 2 blocks for its parameter, so the available number of blocks for data is "the value listed in Table 4-7 – 2."

4.2.5.7 Block List

For encrypted communication in tunnel mode, how to specify block list is slightly different from the JISX6319-4 specification. Figure 4-11 shows the block list referenced from this RFID.

(1) Plaintext (unencrypted) communication in RF communication mode: The block number of block list can be set freely. The RFID references to all block numbers.

(2) Plaintext (unencrypted) communication in tunnel mode: The block number of block list should be set in ascending order. The RFID checks that the block number is set in ascending order and if not, it responds with an error.

(3) Encrypted communication in RF communication mode or tunnel mode: The block number to access is specified using the block numbers between first and (m-2)th in the block list. The last two block numbers are dummy. The block number of block list should be set in ascending order. The RFID checks that the block number is set in ascending order and if not, it responds with an error.

Note: When specifying multiple blocks, communication mode (RF communication mode/ tunnel mode) and encrypted communication for all blocks should be configured to the same setting; if not, the RFID responds with an error.

Note: When setting block numbers in ascending order, set to 0x00 following the block number 0xFF (and set to 0x01 following 0x00). Mode setting (bits 2 to 0 of byte D2) for all blocks should be set to the same value.

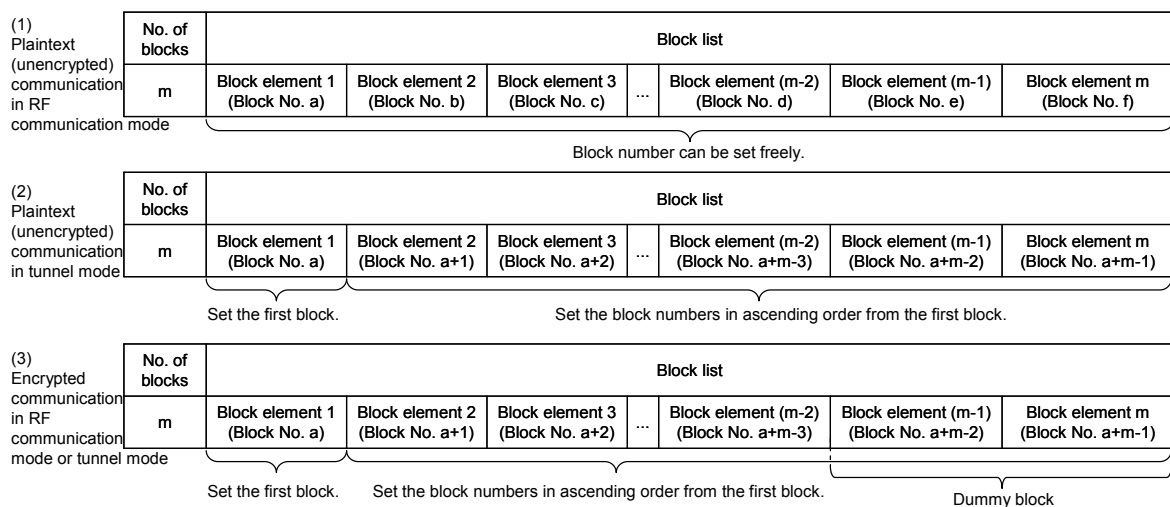

Figure 4-11 Block List Referenced from this RFID

In addition, for encrypted communication, the structure of data is also slightly different from the JISX6319-4 specification. Figure 4-12 shows the block data structure.

(1) Plaintext (unencrypted) communication treats all block data as actual data.

(2) In encrypted communication, of the number of blocks m , the first block data is IV (Initial Vector) to be used for encryption, data from second to $(m-1)$ th blocks are actual data, and the last block data is MAC value for Message Authentication Code (MAC).

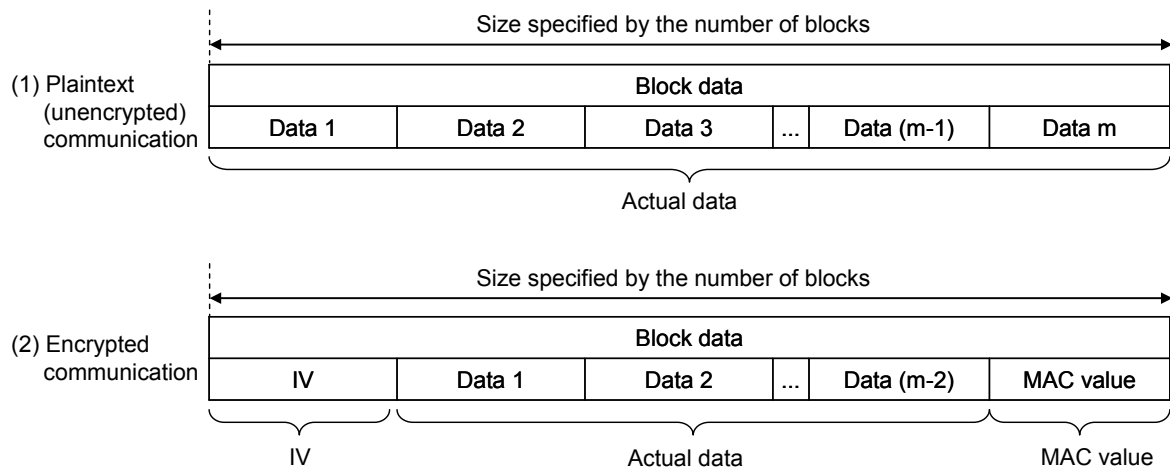

Figure 4-12 Block Data Structure

4.2.5.8 Status Flag

Table 4-8 lists the meanings of status flags.

Table 4-8 Status Flag

Status flag 1	Status flag 2	Meaning	Description
0x00	0x00	Normal end	Terminated normally.
0xFF	0x50	Tunnel mode error	No response from the host
0xFF	0x51	Tunnel mode error	The host responded with an error.
0xFF	0xA1	Service count specification error	The number of service files was out of the specification.
0xFF	0xA2	Block count specification error (*)	The number of blocks was out of the specification.
0xFF	0xA3	Service count specification error	Some settings for multiple service were different from the specification.
0xFF	0xA5	Block specification error	<ul style="list-style-type: none"> • Illegal access mode setting (except All-0) • Illegal mode setting (RFU setting) • Block number was specified outside FeRAM. • Ascending order was not used to specify block numbers in tunnel mode or encrypted communication.
0xFF	0x60	Self-diagnosis error (*)	<ul style="list-style-type: none"> • Write access to FeRAM-Read-Only area (RORF setting) • Plaintext (unencrypted) command access to Encrypted-communication-enable-only area (SECURITY setting)

(*) For more information about these errors, see the Administrator's Manual.

4.2.6 Command

Table 4-9 lists the JISX6319-4 commands supported by this RFID.

Subsequent sections describe each command in detail.

Table 4-9 JISX6319-4 Command List

Name	Code	Description
REQ	0x00	Reader/writer identifies RFID with this command.
READ	0x06	Reads data of RFID from reader/writer or, in tunnel mode, reads data of the host from reader/writer.
WRITE	0x08	Writes data to RFID from reader/writer or, in tunnel mode, writes data to the host from reader/writer.

4.2.6.1 REQ

■ Purpose

Reader/writer identifies RFID with this command.

■ Command message

● Format

Command code	System code	Request code	Timeslot
1 byte	2 bytes	1 byte	1 byte

● Data field

Field	Setting	Remarks
Command code	0x00	
System code	<ul style="list-style-type: none"> 0xFFFF: Identifies all RFIDs. 0xA AFF: Identifies RFID compliant with JIXS6319-4, regardless of category. Other: The RFID corresponding to the specified system code responds. 	
Request code	<ul style="list-style-type: none"> 0x00: No request 0x01: Additional system code request 0x02: Additional transmission protocol capability request 	When values other than the values on the left column are set, the RFID treats this field as 0x00 (no request)
Timeslot	0x00: One slot	This RFID always treats this field as 0x00.

■ Response message

● Format

Response code	PICC identifier	Response time descriptor	Request data
1 byte	8 bytes	8 bytes	0 or 2 bytes

● Data field

Field	Output value	Remarks
Response code	0x01	
PICC identifier	See 4.2.5.2 PICC (Proximity IC Card) Identifier.	
Response time descriptor	See 4.2.5.3 Response Time Descriptor	
Request data	<ul style="list-style-type: none"> Request code 0x00: Request data 0 bytes (No additional data) Request code 0x01: Adds system code. Request code 0x02: 0x0083 (212 kbps, 424 kbps, automatic data rate detection supported) 	

4.2.6.2 READ

■ Purpose

Reads data of RFID from reader/writer or, in tunnel mode, reads data of the host from reader/writer.

■ Command message

● Format

Command code	PICC identifier	No. of service file identifiers (k)	List of service file identifiers	No. of blocks (m)	Block list
1 byte	8 bytes	1 byte	2×k bytes	1 byte	2×m or 3×m bytes

● Data field

Field	Setting	Remarks
Command code	0x06	
PICC identifier	PICC identifier acquired by REQ command described in Section 4.2.6.1 REQ.	
No. of service file identifiers (k)	Number of service files Setting range: 0x01(1) to 0x0F(15)	When the range other than the range on the left column is set, the RFID responds with an error.
List of service file identifiers	Don't care (Setting example: 0x0900)	When specifying multiple services, the RFID responds with an error if all service files are not set to the same value.
No. of blocks (m)	Number of blocks specified in block list Setting range: · Plaintext (unencrypted) communication in RF communication mode: 0x01(1) to 0x0F(15) · Other: 0x01(1) to 0x0F(15)	When the range other than the range on the left column is set, the RFID responds with an error.
Block list	Block list of data to be read For information about how to set, see the following: · 4.2.5.6 · 4.2.5.7	

■ Response message

● Format

Response code	PICC identifier	Status flag 1	Status flag 2	No. of blocks (m)	Block data
1 byte	8 bytes	1 byte	1 byte	1 byte	16×m byte

● Data field

Field	Output value	Remarks
Response code	0x07	
PICC identifier	See 4.2.5.2 PICC (Proximity IC Card) Identifier.	
Status flag 1	See 4.2.5.8 Status Flag	
Status flag 2	See 4.2.5.8 Status Flag.	
No. of blocks (m)	Number of blocks specified by the command	Omitted when the status is not "Normal end"
Block data	See 4.2.5.7 Block List.	Omitted when the status is not "Normal end"

4.2.6.3 WRITE

■ Purpose

Writes data to RFID from reader/writer or, in tunnel mode, writes data to the host from reader/writer.

■ Command message

● Format

command code	PICC identifier	No. of service file identifiers (k)	List of service file identifiers	No. of blocks (m)	Block list	Block data
1 byte	8 bytes	1 byte	2×k bytes	1 byte	2×m or 3×m bytes	16×m bytes

● Data field

Field	Setting	Remarks
Command code	0x08	
PICC identifier	PICC identifier acquired by REQ command described in Section 4.2.6.1	
No. of service file identifiers (k)	Number of service files Setting range: 0x01(1) to 0x0B(11)	When the range other than the range on the left column is set, the RFID responds with an error.
List of service file identifiers	Don't care (Setting example: 0x0900)	When specifying multiple services, the RFID responds with an error if all service files are not set to the same value.
No. of blocks (m)	Number of blocks specified in block list Setting range: · No. of service files is 1 to 8: 0x01(1) to 0x0C(12) · No. of service files is 9 to 11: 0x01(1) to 0x0B(11)	When the range other than the range on the left column is set, the RFID responds with an error.
Block list	Block list of data to be written For information about how to set, see the following: · 4.2.5.6 Block · 4.2.5.7 Block list	
Block data	See 4.2.5.7 Block list	

■ Response message

● Format

Response code	PICC identifier	Status flag 1	Status flag 2
1 byte	8 bytes	1 byte	1 byte

● Data field

Field	Output value	Remarks
Response code	0x09	
PICC identifier	See 4.2.5.2 PICC (Proximity IC Card) Identifier.	
Status flag 1	See 4.2.5.8 Status Flag.	
Status flag 2	See 4.2.5.8 Status Flag.	

4.2.7 NDEF

This RFID is based on Type3 Tag and Type4B Tag of NFC Forum and supports data exchange of a NDEF format.

This section explains Type3 Tag.

In addition, 4.3.10 NDEF explains Type4B Tag of NFC Forum.

Data exchange of NDEF can be performed by performing a predetermined setup to the user area of FeRAM.

Please refer to the applicable written standards of NFC Forum for the details of NDEF.

4.2.7.1 MEMORY MAP

The memory map at the time of NDEF use is shown in Fig. 4-13

Attribute Information Block is arranged to Block0.

NDEF file is arranged from Block1 to Block23.

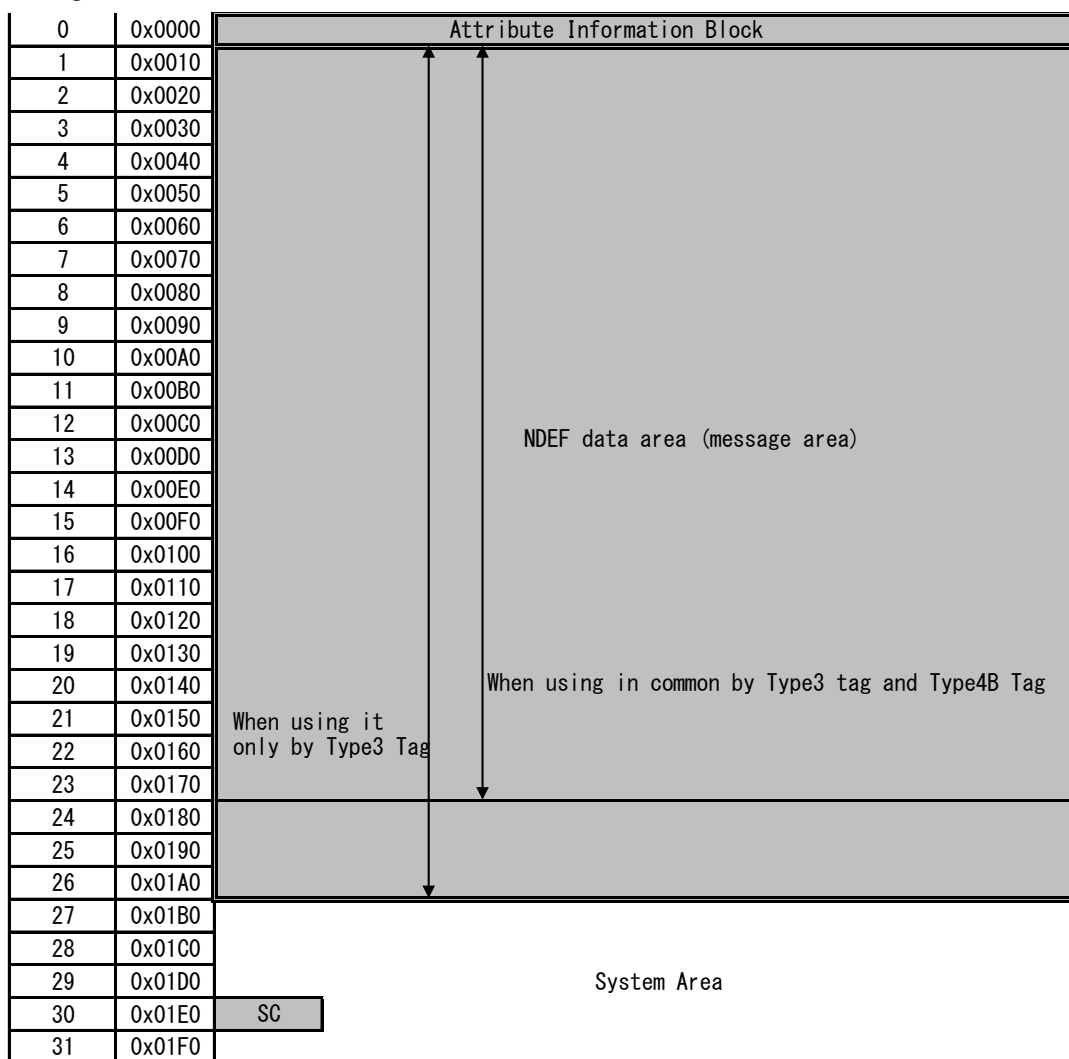

Fig 4-13 The memory map at the time of NDEF use. (NFC Forum Type3 Tag)

4.2.7.2 Setup of System Code (SC)

In order to use NDEF of Type3 Tag, It is necessary to set value "0x12FC." on a system code(SC).

4.2.7.3 Setup of Attribute Information Block

Attribute Information Block(AIB) is arranged to Block0.

Explanation and the example of a setting of Attribute Information Block (AIB) are shown in Table 4-10.

Table 4-10 The example of a setting of Attribute Information Block (AIB)

Physical address	Size	Value	Contents	Supplement
0x0000	1Byte	0x10	Mapping Version	Please set up according to the NDEF standard version to apply.
0x0001	1Byte	0x0F	Nbr (The number of the maximum block of one read command)	Please set up 0x0F in this RFID.
0x0002	1Byte	0x0B	Nbw (The number of the maximum block of one write command)	Please set up 0x0B in this RFID.
0x0003 ~0x0004	2Byte	0x0017	Nmaxb (The number of maximum block of NDEF data which can handle this RFID)	(Note:)
0x0005 ~0x0008	4Byte	0x00000000	Intact area	Please set 4 bytes of 0x00 to all.
0x0009	1Byte	0x00	WriteF 0x00 : Write-in completion 0x0F : Under a write-in advance	Please set "0x0F" before the writing of a NDEF message, and Please set "0x00" after all the writing of a NDEF message completed.
0x000A	1Byte	0x01	RW-Flag 0x00 : AIB is read-only. 0x01 : Read and write are possible for AIB.	
0x000B ~0x000D	3Byte	0x000003	Ln (NDEF message length)	0x000003 = 3Byte (The value to a setting example of a setting of Table 4-11)
0x000E ~0x000F	2Byte	0x0046	Checksum	The sum of data level to address 0x0000 - 0x000D

Note: When sharing a NDEF message by Type3 Tag and Type4B Tag, the maximum of Nmaxb is 0x0017.

When using it only by Type3 Tag, the maximum of Nmaxb is 0x001A.

However, the maximum of Nmaxb may be set to 0x0018 depending on the directions for encryption communication. Refer to the administrator manual for the details of encryption communication.

4.2.7.4 NDEF FILE

An empty NDEF file is shown in Table 4-11 as an example of a setting of a NDEF file.

Table 4-11 The example of a setting of a NDEF file (An empty NDEF file)

Physical address	Size	Value	Contents	Supplement
0x0010 ~0x0012	3Byte	0xD00000	NDEF Message	A mentioned value is a value which shows an empty message.

4.3 ISO/IEC14443 TypeB Specification

This section describes the ISO/IEC14443 TypeB specification.

4.3.1 Communication Specification

Table 4-12 provides the communication specifications of this RFID based on ISO/IEC14443 TypeB.

Table 4-12 ISO/IEC14443 TypeB Communication Specification

Carrier frequency		13.56 MHz
Moduration mode, Bit coding	R/W→RFID	ASK10%, NRZ coding
	RFID→R/W	Load modulation, BPSK coding (848 kHz subcarrier)
Data rate		106 kbps / 212 kbps
Character transmission		<ul style="list-style-type: none"> • LSB-first • Data (8 bits) • Start bit (1 bit) • Stop bit (1 bit)

4.3.2 Frame Format

Figure 4-14 illustrates the ISO/IEC14443 TypeB frame format. SOF(Start Of Frame) and EOF(End Of Frame) are added to a data field. The maximum size of data field is 256 bytes in this RFID.

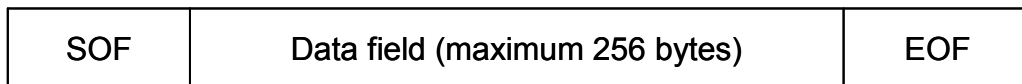

Figure 4-14 ISO/IEC14443 TypeB Frame Format

Additionally, the ISO/IEC14443-4 block format shown in Figure 4-15 is applied to the data field shown in Figure 4-14. This RFID does not support CID and NAD of the first field, so adding them is prohibited.

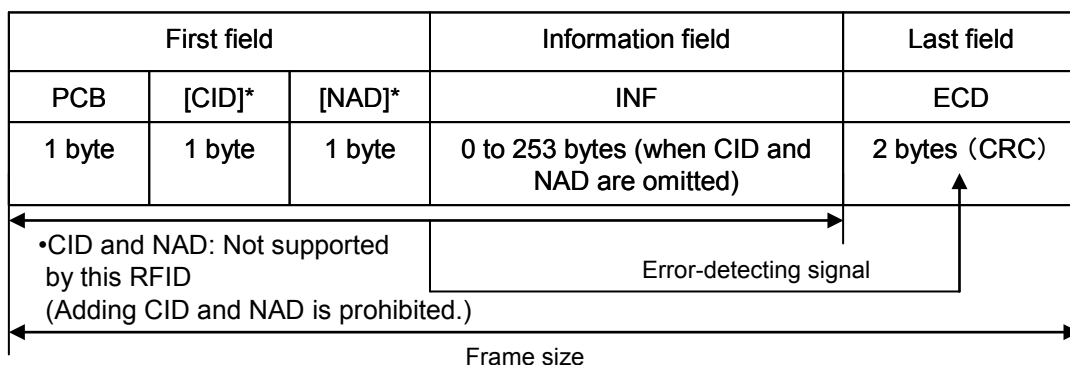

Figure 4-15 ISO/IEC14443-4 Block Format

Table 4-13 ISO/IEC14443-4 Field Definition

Field name	Byte length	Definition
PCB	1	Protocol Control Byte. See 4.3.3 Protocol Control
CID	1	Card Identifier (optional) Used to identify RFID. (Not supported by this RFID; not added.)
NAD	1	Node Address (optional). Used to establish a logical channel. (Not supported by this RFID; not added.)
INF	n	Command message or response message
ECD	2	See CRC_B ISO/IEC14443-3.

4.3.3 Protocol Control

PCB (Protocol Control Byte) shown in Figure 4-15 and Table 4-13 is provided for ISO/IEC14443-4 protocol control, and used to send information necessary for data transmission control. This protocol has 3 block types. Table 4-14 lists the definition of block type. This RFID's protocol control specification is given in Table 4-15.

Figure 4-16, Figure 4-17, and Figure 4-18 illustrate I-block, R-block, and S-block codings, respectively.

Table 4-14 Block Type

Block name	Definition
I-block	Used to send the information of application layer.
R-block	Used to send ACK (Acknowledge) or NAK (NegativeAcknowledge). R-block does not include INF field. An R-block corresponding to the last reception block will be sent.
S-block	Used to send a control information. The following 2 types are provided: 1. Wait time extension request (WTX) 2. DESELECT command

Table 4-15 Protocol Control Specification

Item	Description	By this RFID
CID (Card Identifier)	First field parameter of ISO/IEC14443-4 frame (optional). Used to identify RFID.	Not supported
NAD (Node Address)	First field parameter of ISO/IEC14443-4 frame (optional). Used to establish a logical channel.	Not supported
Chaining	Used to transmit/receive divided data	Supported (however, the size of divisible frame size is 64 bytes or more.)
ACK/NCK response	Used to send ACK (Acknowledge) or NAK (NegativeAcknowledge).	Supported
WTX	Used to extend the wait time for response from RFID	Not supported
DESELECT command	Used to deselect the RFID.	Supported

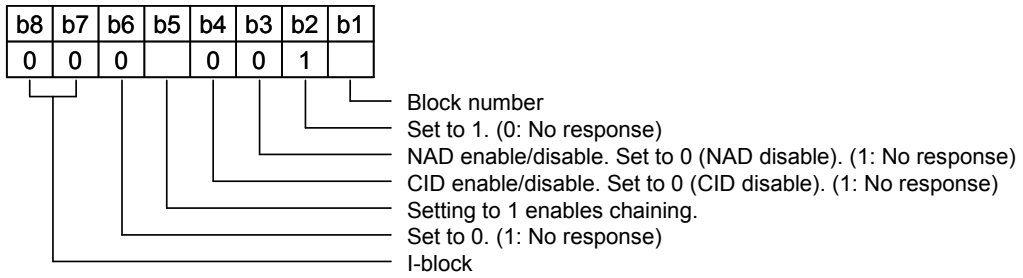

Figure 4-16 I-block Coding

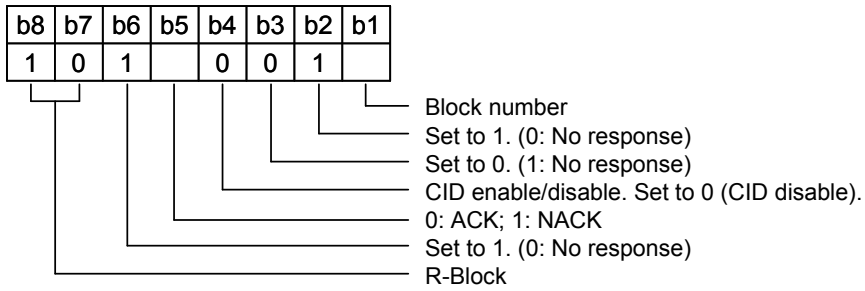

Figure 4-17 R-block Coding

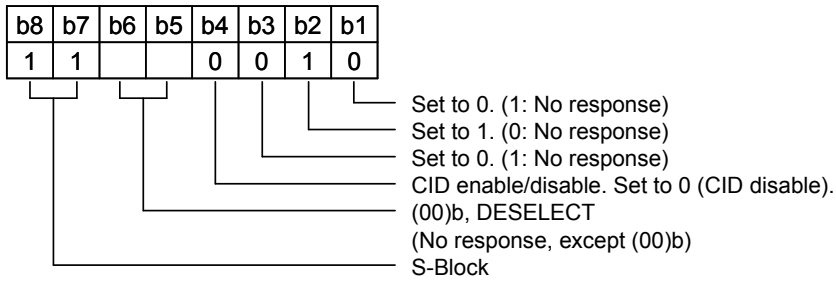

Figure 4-18 S-block Coding

4.3.4 Block Control

The block number rule for ISO/IEC14443-4 I-block is given in Table 4-16. The block control rule and whether to be supported by this RFID are shown in Table 4-17.

Table 4-16 Block Number Rule

Applied to	No.	Rule
Reader/ Writer	RuleA	Set the initial value of reader/writer block number to 0 whenever activating RFID.
	RuleB	When I-block or R(ACK) block whose block number is equal to the current one is received, toggle the current block number before sending the block number to RFID.
RFID	RuleC	Set the initial value of RFID block number to 1 whenever activating RFID.
	RuleD	When I-block is received, toggle the current block number before sending the block.
	RuleE	When R(ACK) block whose block number is not equal to the current one is received, RFID toggles the current block number before sending the block. When R(NAK) is received, do not toggle the block number.

Table 4-17 Block Control Rule

Applied to	No.	Rule	By this RFID
Reader/ Writer and RFID	Rule1	Send the first block from reader/writer.	Supported
	Rule2	When I-block indicating chaining is received, send an affirmative response to the block, with R(ACK) block.	Supported
	Rule3	S-block is used only for pair. Send a response to S(...)block whenever S(...)block is requested.	Only DESELECT supported
Reader/ Writer	Rule4	When an illegal block is received or FWT timeout occurs, send R(NAK) block (except while RFID is in chaining or when S(DESELECT) is executed).	-
	Rule5	When an illegal block is received or FWT timeout occurs while RFID is in chaining, send R(ACK) block.	-
	Rule6	When R(ACK) block is received and its block number is not equal to the block number of reader/writer, re-send the last I-block.	-
	Rule7	When R(ACK) block is received and its block number is equal to the block number of reader/writer, continue chaining.	-
	Rule8	When a response to S(DESELECT) is not sent with no error, re-send S(DESELECT) or ignore the RFID.	-
RFID	Rule9	RFID can send S(WTX) block, instead of I-block or R(ACK) block.	Not supported
	Rule10	When I-block not indicating chaining is not received, send an affirmative response.	Supported
	Rule11	When R(ACK) or R(NAK) block is received and its block number is equal to the block number of RFID, re-send the last I-block.	Supported
	Rule12	When R(NAK) block is received and its block number is not equal to the block number of RFID, send R(ACK).	Supported
	Rule13	When R(ACK) block is received and its block number is not equal to the block number of RFID and RFID is in chaining, continue chaining.	Supported

4.3.5 Upper Command Format

The upper commands (SELECT, READ, WRITE) are compliant with the APDU (Application Protocol Data Unit) format of ISO/IEC7816-4.

Figure 4-19 shows the command APDU format. Table 4-18 shows the command APDU field definition. Figure 4-20 gives the response APDU format. Table 4-19 gives the response APDU field definition.

The command APDU format shown in Figure 4-19 and the response APDU format shown in Figure 4-20 are configured in the information field INF of the ISO/IEC14443-4 block format shown in Figure 4-15.

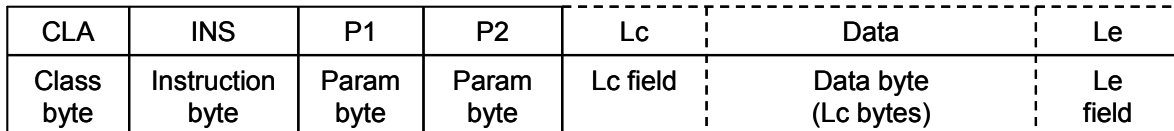

Figure 4-19 Command APDU Format

Table 4-18 Command APDU Field Definition

Field name	Byte length	Definition
Class byte	1	Fixed to 0x00
Instruction byte	1	Instruction code
Param byte 1	1	Command parameter
Param byte 2	1	Command parameter
Lc field	1	If a data byte exists in the command APDU, set the byte length of n; if not, omit the data byte.
Data byte	n	Data block (can be omitted)
Le field	1	If a data byte exists in the response APDU, set the byte length; if not, omit the data byte.

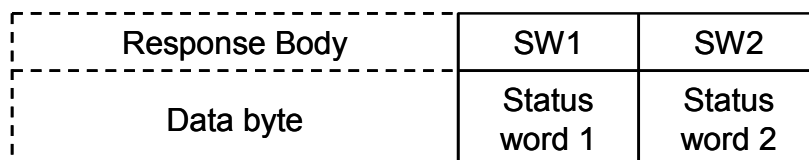

Figure 4-20 Response APDU Format

Table 4-19 Response APDU Field Definition

Field name	Byte length	Definition
Data byte	n	Data block (can be omitted)
Status word 1	1	Status information
Status word 2	1	Status information

4.3.6 State Transition Diagram

Figure 4-21 provides the state transition diagram for this RFID's operation based on ISO/IEC14443 TypeB.

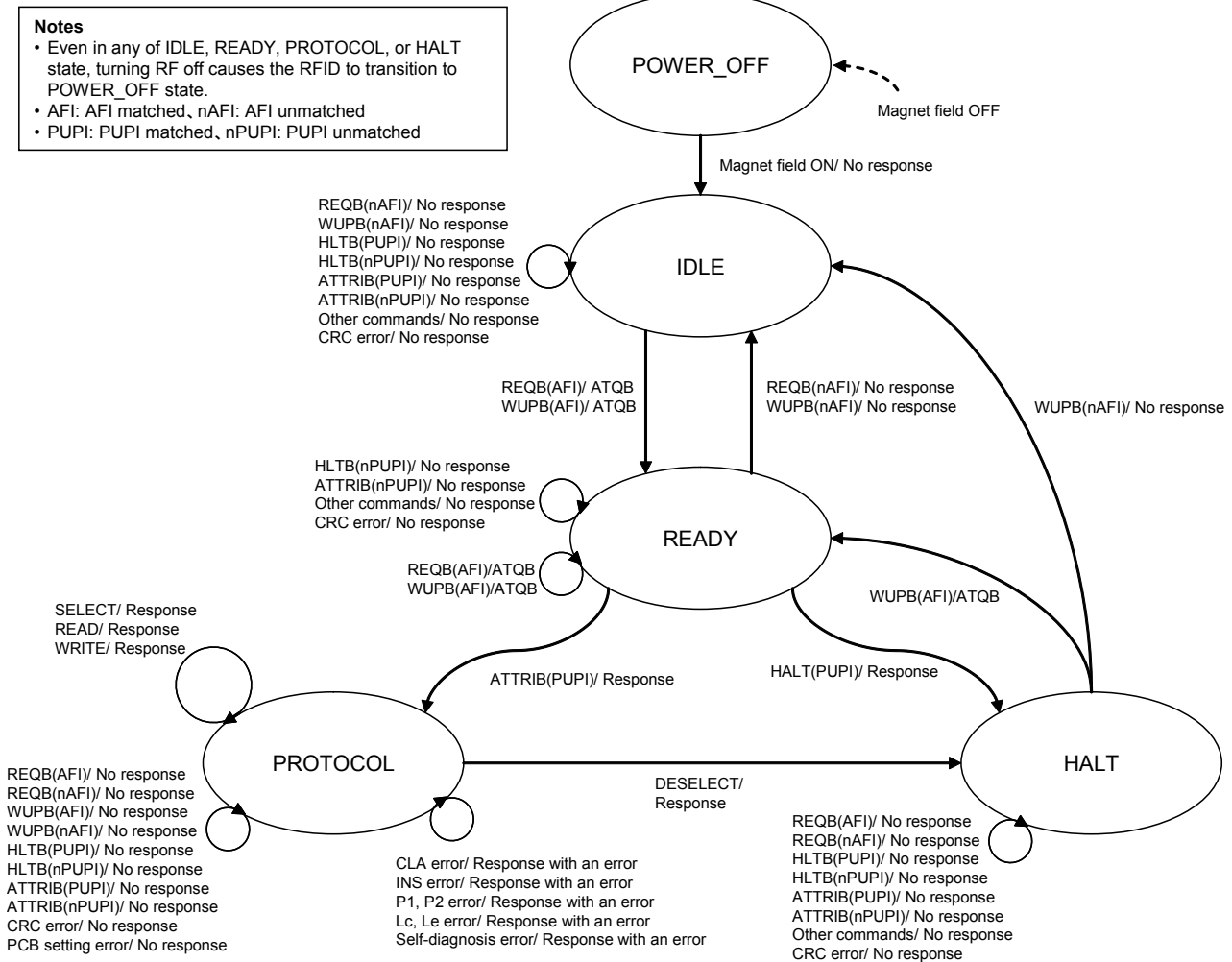

Figure 4-21 State Transition Diagram for Operation Based on ISO/IEC14443 TypeB

4.3.7 Flow Chart

Figure 4-22 illustrates the flow chart for this RFID's command processing based on ISO/IEC14443 TypeB.

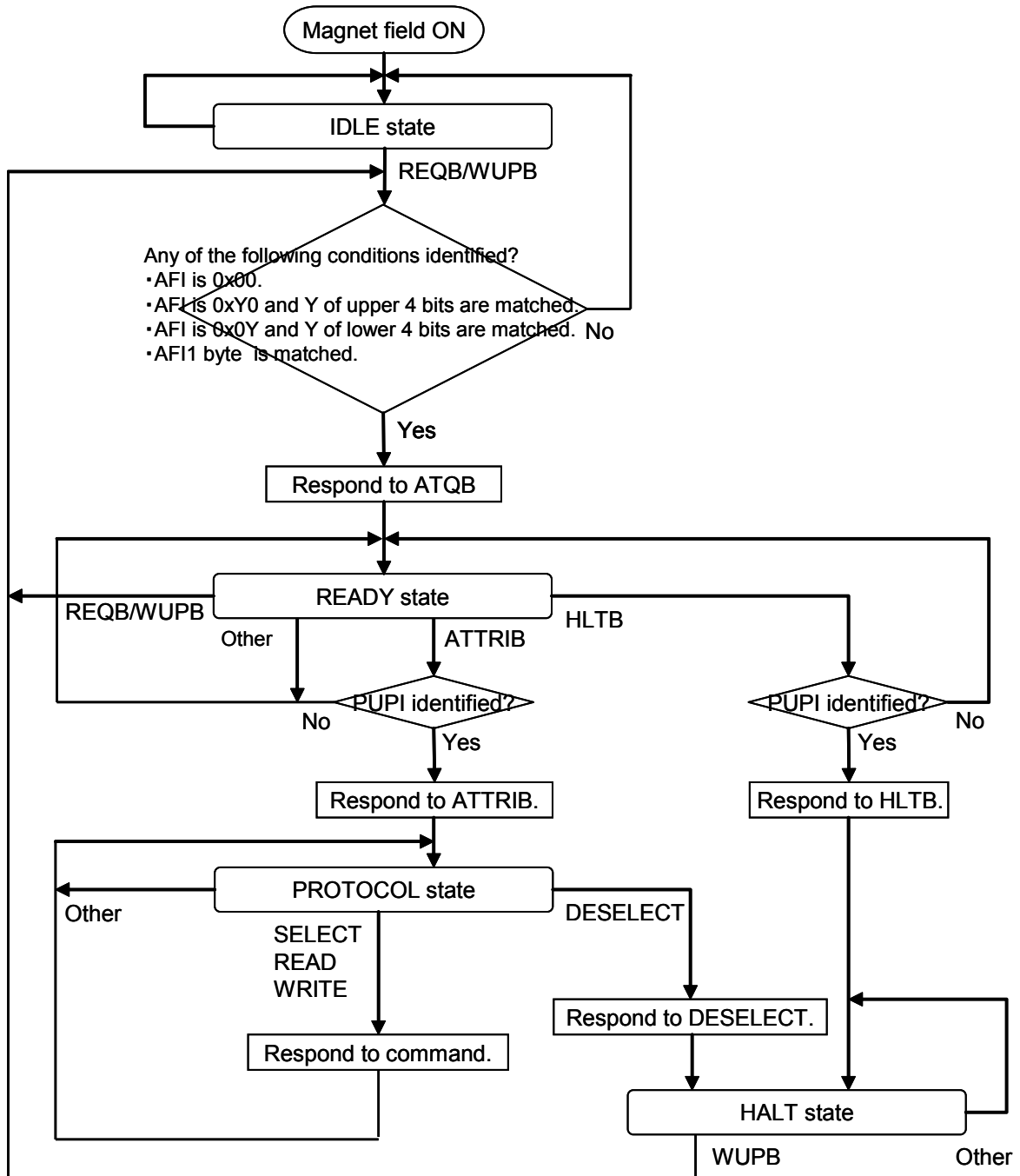

Figure 4-22 Flow Chart of Command Processing Based on ISO/IEC14443 TypeB

4.3.8 Various Settings

This section describes the parameter settings and operation specifications based on ISO/IEC14443 TypeB for this RFID.

4.3.8.1 AFI (Application Family Identifier)

Figure 4-23 shows the format of AFI (Application Family Identifier). The value of AFI is set in the system area AFI.

AFI is a parameter specified by the REQB command. The response operation to REQB command in this RFID is shown in Table 4-20. For information about the setting values for AFI, see ISO/IEC14443-3.



Figure 4-23 AFI Format

Table 4-20 REQB Command Response Operation

REQB command AFI setting value	RFID's response to REQB command
0x00	Responds regardless of the system area AFI setting.
0xY0	Responds when the value Y of the upper 4 bits of the REQB command's AFI is matched.
0x0Y	Responds when the value Y of the lower 4 bits of the REQB command's AFI is matched.
Other	Responds only when the setting value of the REQB command's AFI matches the value specified in the system area AFI.

4.3.8.2 PUPI (Pseudo-Unique PICC Identifier)

Figure 4-24 shows the format of PUPI (Pseudo-Unique PICC Identifier). PUPI is an identifier of PICC (Proximity IC Card). The value of PUPI is set in the lower 4 bytes of the system area IDM.

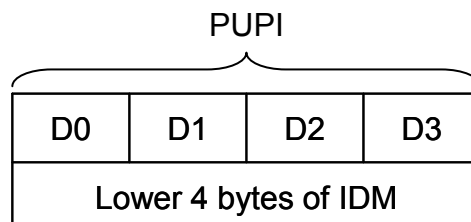

Figure 4-24 PUPI Format

4.3.8.3 FWI (Frame Waiting Time Integer)

Figure 4-25 shows the format of FWI (Frame Waiting time Integer). FWI is used to specify the maximum wait time until the PICC sends a response after receiving a command.

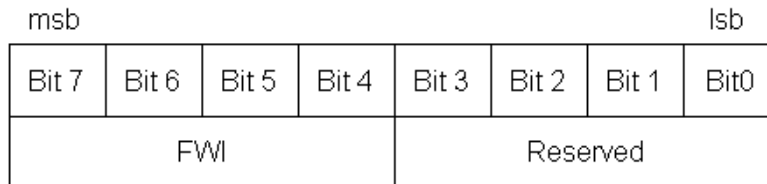

Figure 4-25 FWI Format

The maximum wait time is calculated by the following formula:

$$\text{Maximum wait time} = T \times 2^{\text{FWI}}$$

$$T: 256 \times 16/fc \text{ (} fc = 13.56 \text{ MHz, approx. } 0.302 \text{ ms)}$$

$$\text{FWI: } 0 \text{ to } 14 \text{ (integer)}$$

The maximum wait time ranges from approximately 0.302 ms (min.; FWI = 0) to approximately 4949 ms (max; FWI = 14).

4.3.8.4 File System

This RFID is compliant with the command specification of ISO/IEC7816-4 standards, but does not implement the file system functionality of the standards. However, in order to ensure the compatibility with communication to reader/writer, the SELECT command to select files is set to "Normal response" when specifying the given parameters. For information about how to set the parameters of the SELECT command, see 4.3.9.4 SELECT.

4.3.8.5 Address

In ISO/IEC14443 TypeB (command is compliant with ISO/IEC7816-4), the addresses of READ and WRITE commands are specified by bytes P1 and P2 of the command APDU. (See Section 4.3.5 Upper Command Format)

Figure 4-26 shows the address specification format. Set bit 7 of byte P1 to 0; setting to 1 causes an error.

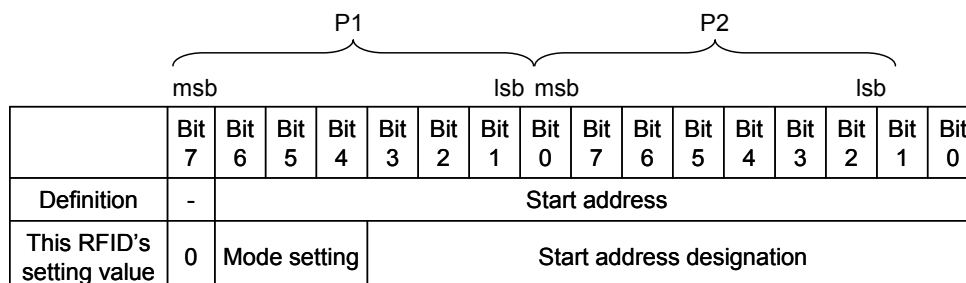

Figure 4-26 Address Specification

This RFID uses address to specify encrypted communication in tunnel mode. Table 4-21 shows mode settings including encrypted communication in tunnel mode with bits 6 to 4 of byte P1.

Table 4-21 Mode Settings

Byte P1			Meaning	
Bit 6	Bit 5	Bit 4	Communication mode	Encrypted communication
-	-	-	RF communication mode	Plaintext (unencrypted) communication
0	0	0		Encrypted communication (private key)
0	1	0		Encrypted communication (family key)
0	1	1	Reserved (Setting this field causes an error.)	
0	0	1	Reserved (Setting this field causes an error.)	
1	0	0	Tunnel mode	Plaintext (unencrypted) communication
1	1	0		Encrypted communication (private key)
1	1	1		Encrypted communication (family key)
1	0	1	Reserved (Setting this field causes an error.)	

In addition, Table 4-22 shows the setting unit for address by communication mode.

Table 4-22 Setting Unit for Address

Communication mode	Setting unit for address (n: integer)
Plaintext (unencrypted)	1×n bytes
Encrypted	16×n bytes

Note: Setting the address to a value other than $16 \times n$ bytes in encrypted communication causes the RFID to respond with an error.

4.3.8.6 Data

For encrypted communication, the structure of data block for READ and WRITE commands is slightly different from the ISO/IEC7816-4 command specification. Figure 4-27 shows the data block structure.

(1) Plaintext (unencrypted) communication treats all block data as actual data.

(2) In encrypted communication, the first 16 bytes of data is IV (Initial Vector) used for encryption, following $16 \times n$ bytes of data is actual data, and the last 16 bytes is MAC value for Message Authentication Code (MAC).

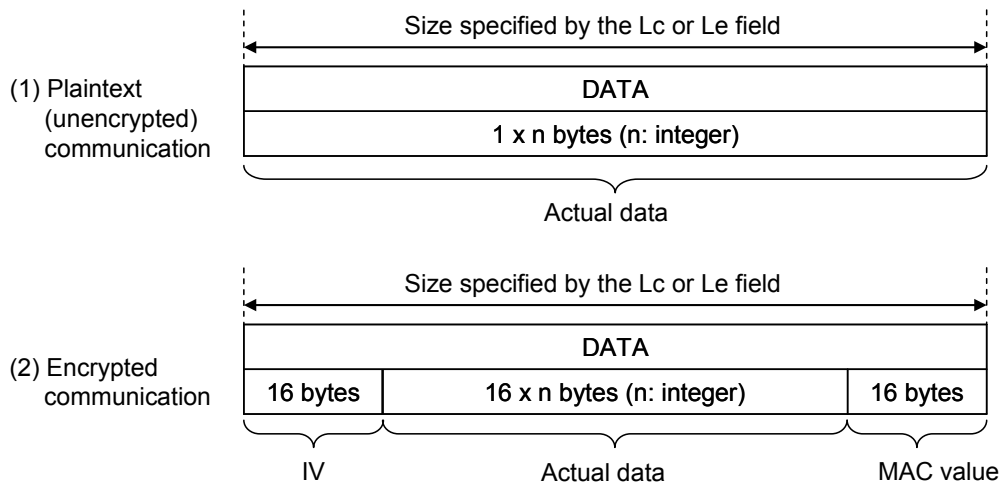

Figure 4-27 Data Block Structure

Note: Setting the data length to a value other than $16 \times n$ bytes in encrypted communication causes the RFID to respond with an error.

4.3.8.7 Status Word

Table 4-23 lists the meaning of statuses.

Table 4-23 Status Word

SW1	SW2	Meaning	Description
0x90	0x00	Normal end	Terminated normally.
0x50	0x00	Tunnel mode error	No response from the host
0x51	0x00	Tunnel mode error	The host responded with an error.
0x67	0x00	Lc/Le specification error (*1)	<ul style="list-style-type: none"> • Lc and Le were out of the specification. • In encrypted communication, Lc and Le were not 16×n bytes.
0x6A	0x86	P1-P2 specification error	<ul style="list-style-type: none"> • Bit 7 of P1 was not 0. (*2) • Illegal mode setting (RFU setting) • Specified outside FeRAM • In encrypted communication, the address was not specified in 16×n byte units.
0x6D	0x00	INS specification error	Illegal INS setting (Specified an unimplemented command)
0x6E	0x00	CLA specification error	Illegal CLA setting (except 0x00)
0x6F	0x00	Self-diagnosis error (*1)	<ul style="list-style-type: none"> • Write access to FeRAM-Read-Only area (RORF setting) • Plaintext (unencrypted) command access to Encrypted-communication-enable-only area (SECURITY setting)

(*1) For more information about these errors, see the Administrator's Manual.

(*2) In the case of SELECT command, it may become "Lc, Le error 0x6700" depending on the combination of values of P1,P2.

4.3.9 Command

The commands based on ISO/IEC14443 TypeB supported by this RFID fall into two types:

Commands defined in ISO/IEC14443-3, and APDU commands defined in ISO/IEC7816-4 to be sent in the ISO/IEC14443-4 format.

These commands are shown in Table 4-24 and Table 4-25.

For information about the command format, see Section 4.3.2 Frame Format and Section 4.3.5 Upper Command Format.

Additionally, protocol control such as chaining, ACK/NAK response (R-Block), and DESELECT (S-Block) are also supported. For its detail, see Section 4.3.3 Protocol Control.

Subsequent sections describe each command in detail.

Table 4-24 ISO/IEC14443-3 TypeB Command List

Name	Code	Description
REQB/WUPB	0x05	Identifies the RFID. Used by reader/writer.
ATTRIB	0x1D	Exchanges protocol signal information between reader/writer and RFID, and causes the RFID to transition to the state in which command processing is enabled.
HLTB	0x50	Transitions the RFID to a HALT state. Used by reader/writer.

Table 4-25 APDU Command List

Name	INS	Description
SELECT	0xA4	Selects the file. (No processing is performed in this RFID.)
READ	0xB0	Reads the data of RFID from reader/writer. While in tunnel mode, reads the data of the host from reader/writer.
WRITE	0xD6	Writes a data to RFID from reader/writer. While in tunnel mode, writes a data to the host.

4.3.9.1 REQB/WUPB

■ Purpose

Identifies the RFID. Used by reader/writer

- REQB is used when the RFID is in IDLE state.
- WUPB is used when the RFID is in HALT state. (It can be also used in IDLE state.)

■ Command message

● Format

Command code	AFI	PARAM	CRC_B
1 byte	1 byte	1 byte	2 bytes

● Data field

Field	Setting	Remarks	
Command code	0x05		
AFI	0x00: Identifies all RFIDs. 0xY0: RFID whose upper 4 bits are identified responds. 0x0Y: RFID whose lower 4 bits are identified responds. Other than 0x00: RFID corresponding to the specified system code responds.	See 4.3.8.1 AFI (Application Family Identifier).	
PARAM	0x00: REQB 0x08: WUPB	This RFID always operates as follows: <ul style="list-style-type: none"> • Ignores the setting of bits 7-5. • Recognizes the number N of Slots is 1 (always responds with ATQB) even when bits 2-0 are set to any of the values (including PFU). 	
	Bits 7-5		RFU (Set to 000b.)
	Bit 4		0: Extension ATQB not supported 1: Extension ATQB supported
	Bit 3		0: REQB 1: WUPB
	Bits 2-0	000b: Slot count N = 1 001b: Slot count N = 2 010b: Slot count N = 4 011b: Slot count N = 8 100b: Slot count N = 16 101b: RFU 110b: RFU	
CRC_B	See CRC_B ISO/IEC14443-3.		

■ Response message

● Format

Response code	PUPI	Application data	Protocol info	CRC_B
1 byte	4 bytes	4 bytes	3 bytes	2 bytes

● Data field

Field	Output value	Remarks	
response code	0x50 (ATQB)		
PUPI	See 4.2.5.2 PICC (Proximity IC Card) Identifier.		
Application Data	0x00000000	Reserved (treated as proprietary data.)	
Protocol Info	1st byte: 0x91	For more information about parameters, see ISO/IEC14443-3.	
	Bits 7-0		Data rate setting: 0x91 <ul style="list-style-type: none"> • R/W→RFID: 106K, 212K bps • RFID→R/W: 106K, 212K bps • R/W→RFID, RFID→R/W (same data rate)
	2nd byte: 0x81		
	Bits 7-4		Maximum frame size of RFID 1000b: 256 bytes
	Bits 3-0		Protocol type: 0001b <ul style="list-style-type: none"> • RFID is ISO/IEC14443-4 compliant • Minimum reader/writer command wait time (TR2) after RFID responds: 10etu + 32/fs (fs = 848 kHz)
	3rd byte: 0xX0 (X is a value of FWI.)		
	Bits 7-4		FWI (Frame Waiting time Integer) See 4.3.8.3 FWI (Frame Waiting Time Integer).
	Bits 3-2		ADC (Application Data Coding) 00b: Proprietary Application Data
Bits 1-0	FO (Frame Option) 00b: NAD, CID not supported		
CRC_B	See CRC_B ISO/IEC14443-3.		

4.3.9.2 ATTRIB

■ Purpose

Exchanges protocol signal information between reader/writer and RFID, and causes the RFID to transition to the state in which command processing is enabled.

■ Command message

● Format

Command code	Identifier	Param1	Param2	Param3	Param4	CRC_B
1 byte	4 bytes	1 byte	1 byte	1 byte	1 byte	2 bytes

● Data field

Field	Setting	Remarks	
Command code	0x1D		
Identifier	Sets PUPI for ATQB response.		
Param1	0x00	This RFID operates with: • bits 1-0 ignored • bits 7-6 set to 00b (when these bits are set to 11b) • bits 5-4 set to 00b (when these bits are set to 11b) This RFID operates with: • Minimum TR0: 64/fs • Minimum TR1: 80/fs • EOF not omitted • SOF not omitted	
	Bits 7-6		Minimum value of RFID response time to reader/writer command (TR0): (fs = 848 kHz) 00b: 64/fs (106 Kbps), 64/fs (212 Kbps) 01b: 48/fs (106 Kbps), 32/fs (212 Kbps) 10b: 16/fs (106 Kbps), 8/fs (212 Kbps) 11b: RFU
	Bits 5-4		Minimum value of the time (TR1) until RFID starts data transmission after subcarrier is generated: (fs = 848 kHz) 00b: 80/fs (106 Kbps), 80/fs (212 Kbps) 01b: 64/fs (106 Kbps), 32/fs (212 Kbps) 10b: 16/fs (106 Kbps), 8/fs (212K bps) 11b: RFU
	Bit 3		0: Do not omit EOF. 1: Omit EOF.
	Bit 2		0: Do not omit SOF. 1: Omit SOF.
	Bits 1-0	RFU (Set to 00b.)	
Param2	0xXX (For XX, see the settings below.)		
	Bits 7-6	RFID→PCD data rate 00b: 106 Kbps 01b: 212 Kbps	
	Bits 5-4	PCD→PICC data rate 00b: 106 Kbps 01b: 212 Kbps	
	Bits 3-0	Maximum receivable frame size of	

		reader/writer 1000b: 256 bytes 0111b: 128 bytes 0110b: 96 bytes 0101b: 64 bytes	PCD→RFID, the RFID will generate no response.
Param3	0x01		If parameters other than those on the left are set, the RFID will generate no response.
	Bits 7-4	RFU (Set to 0000b.)	
	Bits 3-0	Set to the same value as that for the protocol type (4 bits) of the ATQB parameter's second byte.	
Param4	0x00		The RFID operates with: · bits 7-4 ignored · no response generated except when bits 3-0 are set to 0000b
	Bits 7-4	RFU (Set to 0000b.)	
	Bits 3-0	0000b: RFID does not support CID.	
CRC_B	See CRC_B ISO/IEC14443-3.		

■ Response message

● Format

Response code	CRC_B
1 byte	2 bytes

● Data field

Field	Output value		Remarks
response code	1st byte: 0x10		For more information about parameters, see ISO/IEC14443-3.
	Bits 7-4	MBLI (Maximum Buffer Length Integer) 0001b: 1x of RFID frame size (256 bytes)	
	Bits 3-0	0000b: RFID does not support CID.	
CRC_B	See CRC_B ISO/IEC14443-3.		

4.3.9.3 HLTB

- Purpose

Causes the RFID to transition to a HALT state. Used by reader/writer.

- Command message

- Format

Command code	Identifier	CRC_B
1 byte	4 bytes	2 bytes

- Data field

Field	Setting	Remarks
Command code	0x50	
Identifier	Sets the PUPI of the RFID to be set to a HALT state.	
CRC_B	See CRC_B ISO/IEC14443-3.	

- Response message

- Format

Response code	CRC_B
1 byte	2 bytes

- Data field

Field	Output value	Remarks
Response code	0x00	
CRC_B	See CRC_B ISO/IEC14443-3.	

4.3.9.4 SELECT

■ Purpose

Selects the file.

This RFID conforms to the NDEF Ver. 2.0 of NFC forum Type 4B tag and therefore is capable of performing the following selections: EF file, NDEF application, CC file, or NDEF file.

For operations at CC or NDEF file selections, see Section 4.3.10.3 CC File and Section 4.3.10.4 NDEF File.

■ Command message

● Format

CLA	INS	P1	P2	Lc	Data	Le
1 byte	1 byte	1 byte	1 byte	1 byte	n bytes	1 byte

● Data field

Field	Setting	Remarks
CLA	0x00	Responds with an error, except 0x00.
INS	0xA4	
P1	0x00: Selection by a file identifier 0x02: EF file selection 0x04: Selection by DF name (Selection by an application identifier)	A combination except follows is an error reply P1,P2=0x020C : EF file choice
P2	0x00: Designate the corresponding file. 0x0C: FCI generates no response.	P1,P2=0x0400 : NDEF tag application choice P1,P2=0x000C : EF file, CC file or NDEF file choice
Lc	Sets the byte length of the Data block. · Setting range: NDEF tag application selection (when P1, P2 = x0400): 0x07(7) Other than the above: 0x02(2)	Responds with an error, except the setting range on the left column.
Data	NDEF tag application selection (when P1, P2 = x0400): 0xD2760000850101 CC file selection (when P1, P2 = 000C): 0xE103 NDEF file selection (when P1, P2 = 000C): 0x0103 EF file selection (when P1, P2 = 020C): Don't care (This field is set by EF-ID.)	Responds with an error, except the settings on the left column.
Le	Sets the byte length of the Data block for response. · Setting range: 0x00 (with field only for NDEF tag application selection)	Responds with an error, except the setting range on the left column.

- Setting examples

- EF file selection

CLA	INS	P1	P2	Lc	Data
0x00	0xA4	0x02	0x0C	0x02	0XXXXX

In case of the P1,P2=0x020C setting, any value of Data(EF-ID) is settable.

CLA	INS	P1	P2	Lc	Data
0x00	0xA4	0x02	0x0C	0x02	0XXXXX

In case of the P1,P2=0x000C setting, please set Data(EF-ID) any place other than 0xE103 and 0x0103.

- NDEF tag application selection

CLA	INS	P1	P2	Lc	Data	Le
0x00	0xA4	0x04	0x00	0x07	0xD2760000850101	0x00

In case of the NDEF tag application choice, only the value mentioned above is settable.

- CC file selection

CLA	INS	P1	P2	Lc	Data
0x00	0xA4	0x00	0x0C	0x02	0xE103

In case of the CC file application choice, only the value mentioned above is settable.

- NDEF file selection

CLA	INS	P1	P2	Lc	Data
0x00	0xA4	0x00	0x0C	0x02	0x0103

In case of the NDEF file application choice, only the value mentioned above is settable.

ID(File ID) of the NDEF file in this RFID is 0x0103 fixation.

- Response message

- Format

SW1	SW2
1 byte	1 byte

- Data field

Field	Output value	Remarks
SW1	See 4.3.8.7 Status Word.	
SW2	See 4.3.8.7 Status Word.	

4.3.9.5 READ

■ Purpose

Reads the data of RFID from reader/writer. While in tunnel mode, reads the data of the host from reader/writer.

■ Command message

● Format

CLA	INS	P1	P2	Le
1 byte	1 byte	1 byte	1 byte	1 byte

● Data field

Field	Setting	Remarks
CLA	0x00	Responds with an error, except 0x00.
INS	0xB0	
P1	Sets the start address to be read. · See 4.3.8.5 Address.	
P2	Sets the start address to be read. · See 4.3.8.5 Address	
Le	Sets the byte length of data to be read. · Setting range: 0x01(1) to 0xFB(251) · Sets to 16×n (n: integer) for encrypted communication.	Maximum value of n is 15 for encrypted communication.

■ Response message

● Format

Data	SW1	SW2
1 to 251 bytes	1 byte	1 byte

● Data field

Field	Output value	Remarks
Data	Sets the data to be read. · See 4.3.8.6 Data.	Omitted except when status word ends normally.
SW1	See 4.3.8.7 Status Word.	
SW2	See 4.3.8.7 Status Word.	

4.3.9.6 WRITE

■ Purpose

Writes a data to RFID from reader/writer. While in tunnel mode, writes a data to the host.

■ Command message

● Format

CLA	INS	P1	P2	Lc	Data
1 byte	1 byte	1 byte	1 byte	1 byte	1 to 248 bytes

● Data field

Field	Setting	Remarks
CLA	0x00	Responds with an error, except 0x00.
INS	0xD6	
P1	Sets the start address of data to be written. · See 4.3.8.5 Address	
P2	Sets the start address of data to be written. · See 4.3.8.5 Address	
Lc	Sets the byte length of the Data block. · Setting range: 0x01(1) to 0xF8(248) · Sets to 16×n (n: integer) for encrypted communication.	Maximum value of n is 15 for encrypted communication.
Data	Sets the data to be written. · See 4.3.8.6 Data.	

■ Response message

● Format

SW1	SW2
1 byte	1 byte

● Data field

Field	Output value	Remarks
SW1	See 4.3.8.7 Status Word.	
SW2	See 4.3.8.7 Status Word.	

4.3.10 NDEF

This RFID is based on Type3 Tag and Type4B Tag of NFC Forum and supports data exchange of a NDEF format. This section explains Type4B Tag.

In addition, 4.2.7 NDEF explains Type3 Tag of NFC Forum.

Data exchange of NDEF can be performed by performing a predetermined setup to the user area of FeRAM.

Please refer to the applicable written standards of NFC Forum for the details of NDEF.

4.3.10.1 Memory Map

Fig 4-28 shows the memory map in NDEF format.

CC file is assigned to Block 24.

NDEF file is assigned to part of Block 0, and Blocks 1 to 23.

Block	Address	0x0	0x1	0x2	0x3	0x4	0x5	0x6	0x7	0x8	0x9	0xA	0xB	0xC	0xD	0xE	0xF
0	0x0000																
1	0x0010	NDEF Data Area (Message)															
2	0x0020																
3	0x0030																
4	0x0040																
5	0x0050																
6	0x0060																
7	0x0070																
8	0x0080																
9	0x0090																
10	0x00A0																
11	0x00B0																
12	0x00C0																
13	0x00D0																
14	0x00E0																
15	0x00F0																
16	0x0100																
17	0x0110																
18	0x0120																
19	0x0130																
20	0x0140																
21	0x0150																
22	0x0160																
23	0x0170																
24	0x0180	CC File Area															
25	0x0190	User Area															
26	0x01A0	User Area															
27	0x01B0	System Area															
28	0x01C0																
29	0x01D0																
30	0x01E0																
31	0x01F0																

Fig 4-29 Memory map when NDEF is used

4.3.10.2 NDEF Tag Application Selection

This selection requires a SELECT command.

4.3.10.3 CC File

This selection requires a SELECT command.

While in CC file selection, CC file starts from the beginning of Block 24 (physical address 0x0180).

See Table 4-24 shows a setting example of the CC file.

Table 4-26 Example of the CC file

Select address	Physical address	Size	Value	Contents	Remarks
0x0000 ~0x0001	0x0180 ~0x0181	2Byte	0x000F	CCLEN (Length of CC file)	
0x0002	0x0182	1Byte	0x20	Mapping Version	Please set 0x20 in this RFID.
0x0003 ~0x0004	0x0183 ~0x0184	2Byte	0x003B	MLe (The biggest response length of the Read command)	
0x0005 ~0x0006	0x0185 ~0x0186	2Byte	0x0034	Mlc (The biggest response length of the Write command)	
0x0007	0x0187	1Byte	0x04	T field of the NDEF File Control TLV	
0x0008	0x0188	1Byte	0x06	L field of the NDEF File Control TLV	
0x0009 ~0x000A	0x0189 ~0x018A	6Byte	0x0103	V field of the NDEF File Control TLV	File ID Please set 0x 0103 in this RFID.
0x000B ~0x000C	0x018B ~0x018C		0x0032		The biggest NDEF size
0x000D	0x018D		0x00		Read access condition
0x000E	0x018E		0x00		Write access condition

4.3.10.4 NDEF File

This selection requires a SELECT command.

Table 4-25 shows empty NDEF file as a setting example of the NDEF file.

Table 4-25 Setting example of the NDEF file (when NDEF file is empty)

Select address	Physical address	Size	Value	Contents	Remarks
0x0000 ~0x0001	0x000C ~0x000D	2Byte	0x0003	NLEN (NDEF message length)	The size of NLEN is 2Byte fixation.
0x0002 ~0x0004	0x0010 ~0x0012	3Byte	0xD00000	NDEF message	The value shows an empty message

The access to the NDEF file in the NDEF file choice state, I link NLEN and NDEF message and, only other than only NLEN or NDEF message, can access it by 1 command.

In the NDEF file choice state, physical address 0x000C of Block0 the NDEF file top, the top (physical address 0x0010) becomes address 0x0002 of the NDEF file.) of Block1. In other words, the NLEN field of the NDEF file is placed in 0x000C - 0x000D of the physical address, and the NDEF message field is placed by 0x0010 of the physical address.

Chapter 5 Serial Communication Mode

5.1 Serial Communication Mode Sequence

This RFID provides a serial communication function via I2C interface.

The host is the master and the RFID operates as the slave.

Figure 5-1 illustrates the sequence in serial communication mode. Each sequence is described below.

SNo.1 (slave reception): The host sends a serial communication mode command to the RFID.

SNo.2 (slave transmission): Once the RFID receives the serial communication mode command described in SNo.1, it processes the command and then sends the result to the host as the response to the command.

It is also possible to read the status of the RFID by omitting SNo.1 and performing only SNo.2.

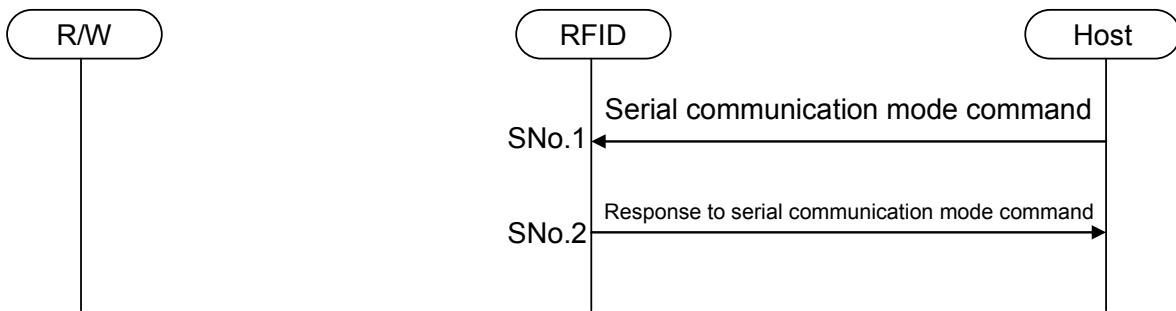

Figure 5-1 Serial Communication Mode Sequence

5.2 I2C

This section describes the I2C specification.

5.2.1 Communication Specifications

Table 5-1 shows the I2C specification of this RFID.

Table 5-1 I2C Communication Specification

Data transfer method	I2C-format, Slave communication
Data rate	20 kHz to 100 kHz
Character transmission	<ul style="list-style-type: none"> · Slave address (7 bits) · Data (8 bits)

5.2.2 Frame Format

Figure 5-2 illustrates the I2C frame format, Table 5-2 defines the field.

Address field	Data field
1 byte	0 to 255 bytes

Figure 5-2 Frame Format

Table 5-2 Field Definition

Field name	Byte length	Definition
Address field	1	Slave address (7 bits) and data direction bit (R/W)
Data field	n	Command message or Response message

When the slave address is identified and the data direction bit is 0, a command is input from the host as slave reception.

When the slave address is identified and the data direction bit is 1, a response is sent to the host as slave transmission.

5.2.3 Specifying Slave Address

The slave address of I2C is specified by I2C_SLV in the system area HW1 of FeRAM.

For more information, see Section 3.3 ■ HW1 (2 bytes) in Section System Area.

5.2.4 Status

Table 5-3 and Table 5-4 show the field format and the meaning of of the RFID's response status, respectively.

Table 5-3 Field Format of RFID Response Status

Field name	Bit position	Description
(Reserved)	Bits 7-6	Unused (Always reads 0.)
RFCMD_IRQ	Bit 5	Indicates whether an RF command interrupt is generated. 0: Not generated 1: Generated
RFDET_IRQ	Bit 4	Indicates whether an magnetic-field detect interrupt is generated. 0: Not generated 1: Generated
CMD_RES	Bits 3-0	Indicates the results of command processing. (See Table 5-4 RFID Response Status (CMD_RES Field).)

Table 5-4 RFID Response Status (CMD_RES Field)

Value	Meaning	Description
0x0	No information	Response has been sent, indicating no information
0x1	Tunnel Read Request (*1)	The tunneling mode Read detection by the RF communication
0x3	Tunnel Read Request (*1)	The tunneling mode Write detection by the RF communication
0x5	Normal end	Terminated normally
0x8	Unimplemented command error Tunnel mode error	The command was an unimplemented one. QUERY and ANSWER commands were issued in IDLE state.
0xA	Command parameter error (*2)	<ul style="list-style-type: none"> • Address was specified outside FeRAM. • Data length was out of the specification.
0xB	Self-diagnosis error	Write access to FeRAM-Read-Only area (ROSI setting)
0x7	BUSY	RFID command processing in progress

(*1) For more information about these errors, see the Administrator's Manual.

(*2) Please refer to the manager manual for this error.

5.2.5 Command

Table 5-5 lists the serial communication mode commands supported by this RFID.

Subsequent sections describe each command in detail.

Table 5-5 Command List in Serial Communication Mode

Name	Code	Description
READ	0x08	Reads an RFID data from the host.
WRITE	0x18	Writes a data to RFID from the host.
RREG	0x68	Reads an RFID control data and interrupt source from the host.
WREG	0x78	Writes a control data to RFID from the host.
STATUS	-	Reads an RFID status information from the host.

5.2.5.1 READ

■ Purpose

Reads an RFID data from the host.

■ Command message

● Format

Command code	Start address	Data length n
1 byte	2 bytes	1 byte

● Data field

Field	Setting	Remarks
Command code	0x08	
Start address	Address at which to start reads	· Byte units · Big endian format
Data length n	Size of data to be read · Setting range: 0x01(1) to 0xFE(254)	Byte units

■ Response message

● Format

Status	Data
1 byte	1 to 254 bytes

● Data field

Field	Output value	Remarks
Status	See 5.2.4 Status.	
Data	Data to be read	See Note below.

Note: If the status of a response message from RFID is not normal (error or busy), data will be omitted.

5.2.5.2 WRITE

- Purpose

Writes a data to RFID from the host.

- Command message

- Format

Command code	Start address	Data length n	Data
1 byte	2 bytes	1 byte	1 to 251 bytes

- Data field

Field	Setting	Remarks
Command code	0x18	
Start address	Address at which to start writes	· Byte units · Big endian format
Data length n	Size of data to be written · Setting range: 0x01(1) to 0xFB(251)	Byte units
Data	Data to be written	

- Response message

- Format

Status
1 byte

- Data field

Field	Output value	Remarks
Status	See 5.2.4 Status.	

5.2.5.3 RREG

■ Purpose

Reads an RFID control data and interrupt source from the host.

■ Command message

● Format

Command code
1 byte

● Data field

Field	Setting	Remarks
Command code	0x68	

■ Response message

● Format

Status	Data
1 byte	1 byte

● Data field

Field	Output value		Remarks
Status	See 5.2.4 Status.		
Data	Bit 7	Reserved (Indefinite)	The output of this bit takes either "0" or "1".
	Bit 6	Masks RF communication detect interrupt.	Set by the WREG command.
	Bit 5	Masks magnet-field detect interrupt.	Set by the WREG command.
	Bit 4	Stops RF communication.	Set by the WREG command.
	Bit 3	Detects magnetic field. 0: Not detected (with no RF carrier) 1: Detected (with RF carrier)	This bit is valid when magnetic-field detect interrupt is enabled with the system area HW2 parameter's IRQSEL specified.
	Bits 2-1	Reserved (Fixed at 0)	
	Bit 0	BCC error 0: None 1: BCC error	Reads the BCC check results for values of the system area. For BCC check, see the Administrator's Manual.

5.2.5.4 WREG

■ Purpose

Writes a data to RFID from the host.

■ Command message

● Format

Command code	Data
1 byte	1 byte

● Data field

Field	Setting		Remarks
Command code	0x78		
Data	Bit 7	Reserved (set to 0.)	
	Bit 6	Masks RF communication detect interrupt. 0: Disable (default) 1: Enable	Setting to 1 masks RF communication detect interrupt (including write detect interrupts), regardless of the system area HW2 parameter's IRQSEL setting.
	Bit 5	Masks magnet-field detect interrupt. 0: Disable (default) 1: Enable	Setting to 1 masks magnet-field detect interrupt, regardless of the system area HW2 parameter's IRQSEL setting.
	Bit 4	Stops RF communication. 0: Disable (default) 1: Enable	Setting to 1 disables RF communication temporarily.
	Bits 3-1	Reserved (Set to 0.)	
	Bit 0	Requests a reset. 0: Normal operation (default) 1: Enable	Self-reset the LSI after sending a response to WREG command

■ Response message

● Format

Status
1 byte

● Data field

Field	Output value	Remarks
Status	See 5.2.4 Status.	

5.2.5.5 STATUS

■ Purpose

Reads an RFID status information from the host.

■ Command message

The STATUS command has no command message.

A slave transmission request serves as a STATUS command.

■ Response message

● Format

Status
1 byte

● Data field

Field	Output value	Remarks
Status	See 5.2.4 Status.	

Note: The response message to the STATUS command immediately after RREG response is 0xXb (self-diagnosis error) or 0xX7 (BUSY) in under RF processing
4 bits (CMD_RES field) of low ranks of the response message to the STATUS command immediately after RREG response should be disregarded.

5.2.6 Time Chart

Figure 5-3 shows the time chart when I2C is used.

t0: The host inputs a start condition and then inputs a slave address and R/W bit (L). The RFID returns an ACK if the slave address is identified. Subsequently, if the host inputs a command data, the RFID returns an ACK in byte units. The host inputs a stop condition last. Pull up the NIRQ pin to high.

t1: The host stops the clock input to the SCK pin after inputting command data. The RFID executes command processing internally.

t2: Once the internal command processing is completed, the RFID outputs low to the NIRQ pin to send a response.

t3: The host detects the low output of the NIRQ pin and inputs a start condition, and then inputs a slave address and R/W bit (H). The RFID returns an ACK and stops the low output of the NIRQ pin if the slave address is identified. Subsequently, if the host inputs a clock to the SCK pin, the RFID returns an ACK in byte units. The host inputs an ACK in byte units, and inputs an NACK and stop condition last.

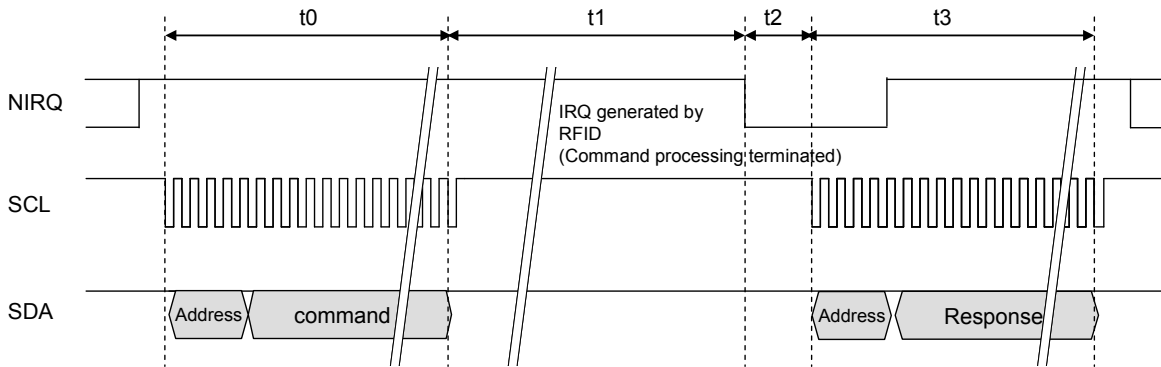

Figure 5-3 Time Chart

Chapter 6 Interrupt Generation Function

6.1 Interrupt Source

This RFID provides an NIRQ pin for interrupt output. A low output to the pin enables IRQ notification to notify the host of generation of an interrupt.

Interrupt sources are described below.

- Serial communication interrupt

An IRQ that is caused by serial communication and issued when processing of the command input from the host is completed.

Serial communication interrupt cannot be masked.

- RF communication detect interrupt

An IRQ that is caused by RF communication and issued either when RF response before transmission or when a write to FeRAM with the RF command is completed.

The system area HW2 parameter's IRQSEL selects whether interrupt is generated and the interrupt source. Bit 2 selects whether interrupt is generated and bit 1 selects the interrupt source.

In addition, even when interrupt generation is enabled, the WREG command for serial command can mask the IRQ.

- Magnetic-field detect interrupt

An IRQ that is caused by RF magnetic-field detection and issued when an RF magnetic field by reader/writer is detected.

Bit 0 of the system area HW2 parameter's IRQSEL selects whether interrupt is generated.

In addition, even when interrupt generation is enabled, the WREG command for serial command can mask the IRQ.

While the contact power supply VDDEX is not applied, an IRQ is issued by starting a power supply due to RF magnetic field. However, when RF magnetic field disappears, power supply will be stopped and low output of the NIRQ pin will be stopped.

Any of the IRQs described above are canceled when the slave address is identified by a slave transmission request from the host, and low output of the NIRQ pin will be stopped.

Note: If the internal voltage VDDD has not reached the reference voltage, an internal reset occurs.

Internal voltage can be generated from the higher voltage either the VDDA and VDDEX.

Therefore, it is possible to set to 1.84V or higher VDDEX at least, generation of the internal reset will be avoided.

7.1 Tunnel Mode Sequence

This section describes the sequence of tunnel mode, which is shown in Figure 7-1.

SNo.1: Reader/writer sends a tunnel mode command to RFID.

SNo.2: RFID receives the tunnel mode command and issues an interrupt request (IRQ) to the host.

SNo.3: If VDDEX is not applied, the host applies VDDEX.

SNo.4: The host sends a QUERY command (inquiry) to RFID.

SNo.5: RFID sends a response to the QUERY command to the host. The response includes data of the tunnel mode command in step SNo.1.

SNo.6: The host sends an ANSWER command (notification of the result) to RFID. The command includes data to be sent to reader/writer.

SNo.7: RFID receives the ANSWER command and sends a response (processing result; Normal end or Error) to the command to the host.

SNo.8: After sending the response to the ANSWER command in step SNo.7, RFID sends the data of the ANSWER command to reader/writer as a response to the tunnel mode command.

For more information about tunnel mode operation, see Section 8.2 State Transition Diagram in Operation Mode, Section 8.3 Flow Chart in Tunnel Mode, or other related sections.

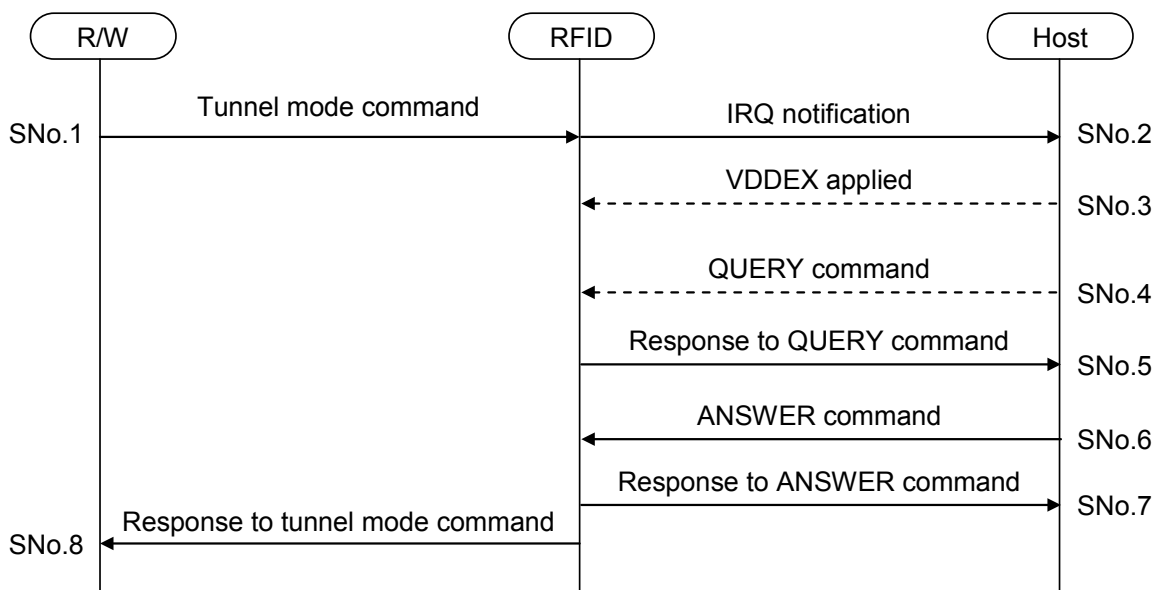

Figure 7-1 Tunnel Mode Sequence

7.2 Communication between Reader/Writer and RFID

This section describes the communication between Reader/Writer and RFID in tunnel mode, based on JISX6319-4 and ISO/IEC14443 TypeB.

7.2.1 Using JISX6319-4

READ and WRITE commands, same as those of RF communication mode, are used.

Use the given bits of block number to set the tunnel mode commands. For more information, see Section 4.2.5.6 SectionBlock.

For information on how to set block list and block data, see Section 4.2.5.7 Block List.

7.2.2 Using ISO/IEC14443

READ and WRITE commands, same as those of RF communication mode, are used.

Use the given bits of address (P1, P2) to set the tunnel mode commands. For more information, see Section 4.3.8.5 Address.

For information on how to set data, see Section 4.3.8.6 Data.

7.3 Communication between Host and RFID

This section describes the I2C communication between the host and RFID in tunnel mode.

7.3.1.1 Communication Specification

The specification for I2C communication is the same as that for serial communication mode. See Section 5.2 I2C.

QUERY and ANSWER commands are provided only for tunnel mode. For more information about commands, see Section 7.4 Command.

7.3.1.2 IRQ Notification

Once this RFID receives a tunnel mode command from reader/writer, it sends an IRQ to the host.

IRQ is output from the NIRQ pin. The NIRQ pin also outputs IRQs in other modes than tunnel mode by setting the system area HW2 parameter's IRQSEL. For more information about IRQSEL, see Section 3.3 ■HW1 (2 bytes) in Section System Area.

When the host receives an IRQ and detects that the supply voltage VDDEX is not applied, it applies VDDEX and sends a QUERY command to the RFID. The RFID can receive I2C commands at the falling edge of NIRQ.

In addition, if the RFID does not receive a QUERY command from the host even when the maximum wait time for QUERY command specified in the system area QWT elapses after the NIRQ pin outputs low, it detects a timeout. For more information, see Section 8.3 Flow Chart in Tunnel Mode.

7.3.2 Response to QUERY Command

When a response to QUERY command in tunnel mode is sent, the RFID reports the content of the command from reader/writer to the host.

The address setting for response to QUERY is shown in Figure 7-2.

Bit 7 of upper byte is fixed to 0 and bit 6 is fixed to 1. Setting bit 6 to 1 indicates the RFID is in tunnel mode. Bits 5 and 4 indicate mode.

Table 7-1 shows the meaning of mode of upper byte bits 5 and 4. These bits indicate whether the communication in tunnel mode is plaintext (unencrypted) or encrypted (private or family key).

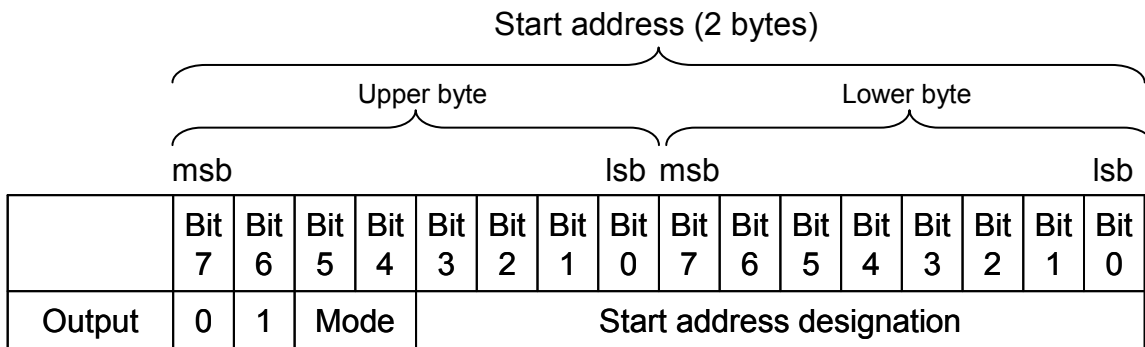

Figure 7-2 Address Setting for Response to QUERY Command

Table 7-1 QUERY Response Mode

Upper byte		Meaning
Bit 5	Bit 4	
0	0	Plaintext (unencrypted) communication
1	0	Encrypted communication (private key)
1	1	Encrypted communication (family key)
0	1	Reserved

Note: Encrypted communication in tunnel mode should be controlled by the host (e.g., plaintext communication is enabled or disabled) using the information of upper byte bits 5 and 4 of start address for the response to QUERY.

7.3.3 Timeout

In tunnel mode command processing for communication between host and RFID, a timeout processing is applied if the host sends no response to QUERY and ANSWER commands.

Figure 7-3 shows the wait time for commands in tunnel mode.

Subsequent section describes the wait time for QUERY and ANSWER commands.

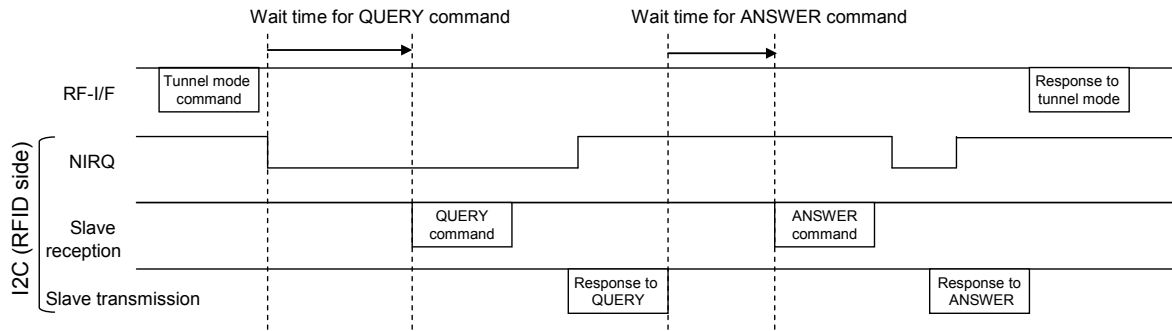

Figure 7-3 Wait Time for Commands

Note: In timeout measurement processing for I2C, the start of command is detected at the start of ACK transmission to a slave address input, not start condition.

7.3.3.1 Wait Time for QUERY Command

The time sequence for timeout of waiting for QUERY command (no response from the host) is shown in Figure 7-4. The measurement of timeout starts when the IRQ state of NIRQ pin changes to low from high. A timeout time is QWT setting time.

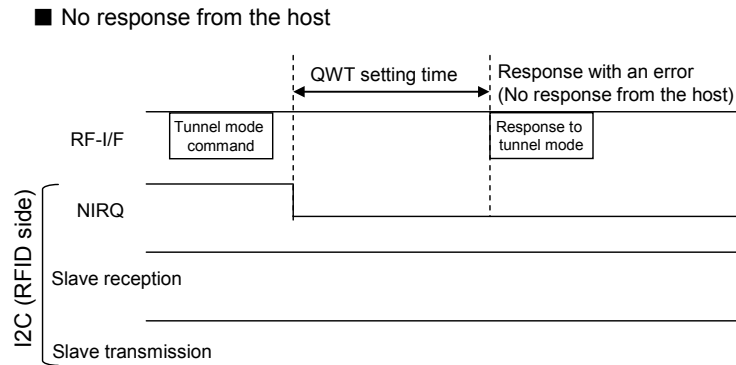

Figure 7-4 Timeout of Waiting for QUERY Command (No Response from the Host)

Next, the time sequence when the RFID receives a command other than QUERY from the host while it waits for a QUERY command is shown in Figure 7-5. Note that the timeout measurement time does not include the time from serial communication command issue to the response to the command.

For more information, see Section 8.3 Flow Chart in Tunnel Mode.

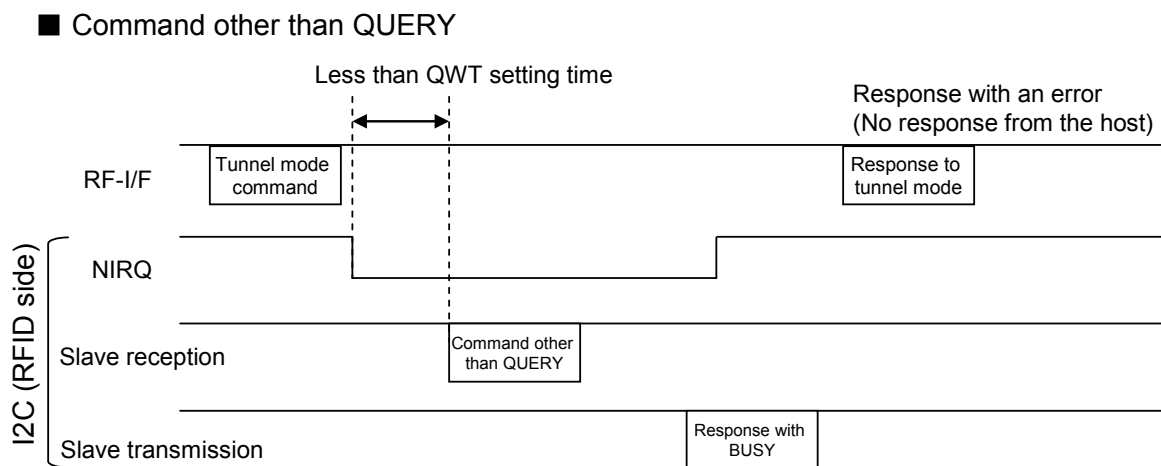

Figure 7-5 Timeout of Waiting for QUERY Command (Command Other Than QUERY)

7.3.3.2 Wait Time for ANSWER Command

The time sequence when the RFID receives no response from the host while it waits for an ANSWER command is shown in Figure 7-6. The measurement of timeout starts immediately after the first response (to normal QUERY command) is sent.

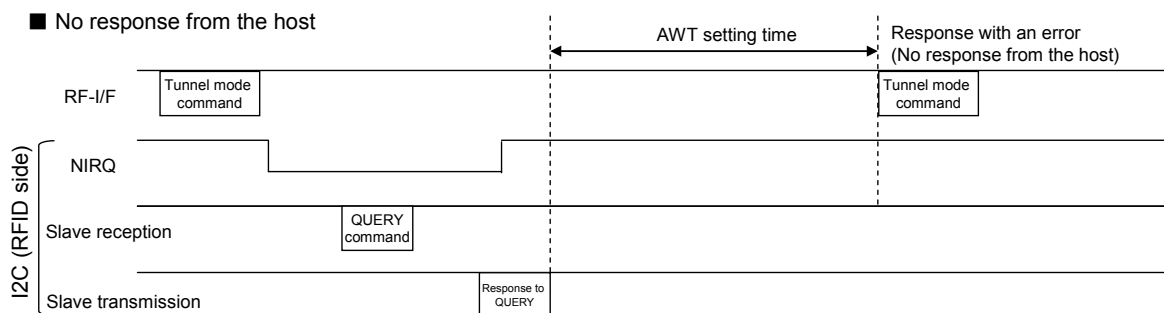

Figure 7-6 Timeout of Waiting for ANSWER Command (No Response from the Host)

Next, the time sequence when the RFID receives a command other than ANSWER from the host while it waits for an ANSWER command is shown in Figure 7-7. Note that the timeout measurement time does not include the time from serial communication command issue to the response to the command.

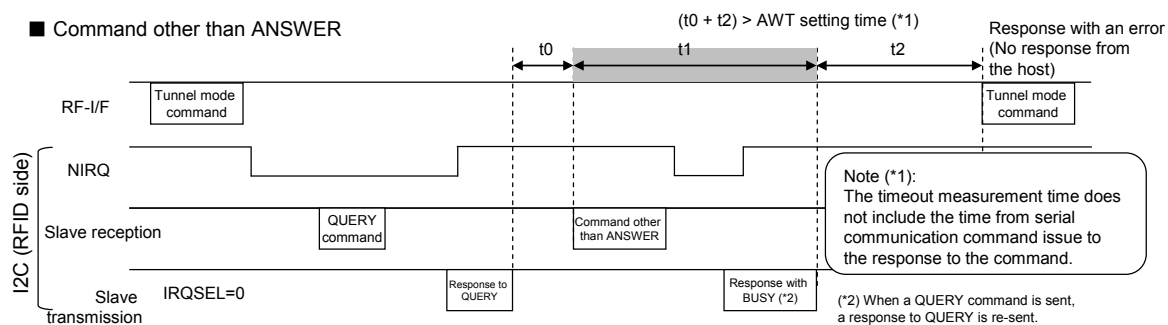

Figure 7-7 Timeout of Waiting for ANSWER Command (Command Other Than ANSWER)

7.4 Command

The tunnel mode commands supported by this RFID fall into two types:

RF-interface-side commands between reader/writer and RFID and serial-interface-side commands between the host and RFID.

These commands are shown in Table 7-2 and Table 7-3.

Subsequent sections describe each command in detail.

Table 7-2 RF Interface Command List in Tunnel Mode

Name	Code		Description
	JISX6319-4	ISO/IEC 14443TypeB	
READ	0x06	0xB0	Reads data of the host from reader/writer. (Command code is the same as that for RF communication mode)
WRITE	0x08	0xD6	Writes data to the host from reader/writer. (Command code is the same as that for RF communication mode)

Table 7-3 Serial-Communication-Side Commands List in Tunnel Mode

Name	Code	Description
QUERY	0x28	The host inquires about the content of tunnel mode command to RFID.
ANSWER (normal end)	0xF8	The host reports the processing result (normal end) of tunnel mode command to RFID.
ANSWER (error)	0xE8	The host reports the processing result (error) of tunnel mode command to RFID.

7.4.1 Read in Tunnel Mode

■ Purpose

Reads data of the host from reader/writer via RFID.

1. Read Command in Tunnel Mode (Reader/Writer to RFID)

■ JIX6319-4

● Format

Command code	PICC identifier	No. of service file identifiers (k)	List of service file identifiers	No. of blocks (m)	Block list
1 byte	8 bytes	1 byte	2×k byte	1 byte	2×m or 3×m bytes

● Data field

Field	Setting	Remarks
Command code	0x06	
PICC identifier	PICC identifier acquired by REQ command described in Section 4.2.6.1 REQ.	
No. of service file identifiers (k)	Number of service files Setting range: 0x01(1) to 0x0F(15)	When the range other than the range on the left column is set, the RFID responds with an error.
List of service file identifiers	Don't care (Setting example: 0x0900)	When specifying multiple services, the RFID responds with an error if all service files are not set to the same value.
No. of blocks (m)	Number of blocks specified in block list Setting range: · Plaintext (unencrypted) communication in RF communication mode: 0x01(1) to 0x0F(15) · Other communication: 0x01(1) to 0x0F(15)	When the range other than the range on the left column is set, the RFID responds with an error.
Block list	Block list of data to be read For information about how to set, see the following: · See 4.2.5.6 Block. · See 4.2.5.7 Block List.	

■ ISO/IEC14443 TypeB

● Format

CLA	INS	P1	P2	Le
1 byte	1 byte	1 byte	1 byte	1 byte

- Data field

Field	Setting	Remarks
CLA	0x00	Responds with an error, except 0x00.
INS	0xB0	
P1	Start address of data to be read · See 4.3.8.5 Address.	
P2	Start address of data to be read · See 4.3.8.5 Address.	
Le	Byte length of data to be read · Setting range: 0x01(1) to 0xFB(251) · Set to 16×n (n: integer) for encrypted communication.	Maximum value of n is 15 for encrypted communication

2. QUERY Command (Host to RFID)

- Format

Command code
1 byte

- Data field

Field	Setting	Remarks
Command code	0x28	

3. QUERY Response (RFID to Host)

- Format

Response code	Start address	Data length n
1 byte	2 bytes	1 byte

- Data field

Field	Setting	Remarks
Response code	See 5.2.4 Status.	
Start address	Address at which to start reads	· Byte units · Big endian format
Data length n	Size of data to be read	Byte units

4. ANSWER Command (Host to RFID)

- Format

Command code	Data
1 byte	n bytes

- Data field

Field	Output value	Remarks
Command code	0xF8: Normal end 0xE8: Error	
Data	Data of the range specified by the response to the QUERY command	See Note below.

Note: If the status of the ANSWER command is "error," omit the data.

5. ANSWER Response (RFID to Host)

- Format

Status
1 byte

- Data field

Field	Output value	Remarks
Status	See 5.2.4 Status.	

6. Read Response in Tunnel Mode (RFID to Reader/Writer)

- JIX6319-4

- Format

Response code	PICC identifier	Status flag 1	Status flag 2	No. of blocks (m)	Block data
1 byte	8 bytes	1 byte	1 byte	1 byte	16×m bytes

- Data field

Field	Output value	Remarks
Response code	0x07	
PICC identifier	See 4.2.5.2 PICC (Proximity IC Card) Identifier.	
Status flag 1	See 4.2.5.8 Status Flag.	
Status flag 2	See 4.2.5.8 Status Flag.	
No. of blocks (m)	Number of blocks specified by the tunnel mode read command	Omitted when the status is not "Normal end"
Block data	Data specified by the ANSWER command · See 4.2.5.7 Block List.	Omitted when the status is not "Normal end"

- ISO/IEC14443 TypeB

- Format

Data	SW1	SW2
1 to 251 bytes	1 byte	1 byte

- Data field

Field	Output value	Remarks
Data	Read data See 4.3.8.6 Data.	Omitted when the status word is not "Normal end"
SW1	· See 4.3.8.7 Status Word.	
SW2	· See 4.3.8.7 Status Word.	

7.4.2 Write in Tunnel Mode

■ Purpose

Writes a data to the host from reader/writer, via RFID.

1. Write Command in Tunnel Mode (Reader/Writer to RFID)

■ JIX6319-4

● Format

Command code	PICC identifier	No. of service file identifiers (k)	List of service file identifier	No. of blocks (m)	Block list	Block data
1 byte	8 bytes	1 byte	2×k bytes	1 byte	2×m or 3×m bytes	16×m bytes

● Data field

Field	Setting	Remarks
Command code	0x08	
PICC identifier	PICC identifier acquired by REQ command described in Section 4.2.6.1 REQ.	
No. of service file identifiers (k)	Number of service files Setting range: 0x01(1) to 0x0B(11)	When the range other than the range on the left column is set, the RFID responds with an error.
List of service file identifier	Don't care (Setting example: 0x0900)	When specifying multiple services, the RFID responds with an error if all service files are not set to the same value.
No. of blocks (m)	Number of blocks specified by block list Setting range: · 1 to 8 service files: 0x01(1) to 0x0C(12) · 9 to 11 service files: 0x01(1) to 0x0B(11)	When the range other than the range on the left column is set, the RFID responds with an error.
Block list	Block list of data to be written For information about how to set, see the following: · See 4.2.5.6 Block. · See 4.2.5.7 Block List.	
Block data	See 4.2.5.7 Block List.	

- ISO/IEC14443 TypeB
- Format

CLA	INS	P1	P2	Lc	Data
1 byte	1 byte	1 byte	1 byte	1 byte	1 to 248 bytes

- Data field

Field	Setting	Remarks
CLA	0x00	Responds with an error, except 0x00
INS	0xD6	
P1	Start address of data to be written · See 4.3.8.5 Address.	
P2	Start address of data to be written · See 4.3.8.5 Address.	
Lc	Byte length of Data block Setting range: 0x01(1) to 0xF8(248) · Set to 16×n (n: integer) for encrypted communication.	Maximum n = 15 for encrypted communication
Data	Write data · See 4.3.8.6 Data.	

2. QUERY Command (Host to RFID)

- Format

Command code
1 byte

- Data field

Field	Setting	Remarks
Command code	0x28	

3. QUERY Response (RFID to Host)

- Format

Response code	Start address	Data length n	Data
1 byte	2 bytes	1 byte	n bytes

- Data field

Field	Setting	Remarks
Response code	See 5.2.4 Status.	
Start address	Address at which to start writes	· Byte units · Big endian format
Data length n	Size of data to be written	Byte units
Data	Data to be written to the host	

4. ANSWER Command (Host to RFID)

- Format

Command code
1 byte

- Data field

Field	Output value	Remarks
Command code	0xF8: Normal end 0xE8: Error	

5. ANSWER Response (RFID to Host)

- Format

Status
1 byte

- Data field

Field	Output value	Remarks
Status	See 5.2.4 Status.	

6. Write Response in Tunnel Mode (RFID to Reader/Writer)

■ JIX6319-4

● Format

Response code	PICC identifier	Status flag 1	Status flag 2
1 byte	8 bytes	1 byte	1 byte

● Data field

Field	Output value	Remarks
Response code	0x09	
PICC identifier	See 4.2.5.2 PICC (Proximity IC Card) Identifier.	
Status flag 1	See 4.2.5.8 Status Flag.	
Status flag 2	See 4.2.5.8 Status Flag.	

■ ISO/IEC14443 TypeB

● Format

SW1	SW2
1 byte	1 byte

● Data field

Field	Output value	Remarks
SW1	See 4.3.8.7 Status Word.	
SW2	See 4.3.8.7 Status Word.	

8.1 Exclusive Control

While in operation mode, this RFID performs an exclusive control not to receive other commands.

Figure 8-1 shows the exclusive control period. The period is from the start of an operation mode command to the end of the response to the command. In tunnel mode, the period is from the start of the tunnel mode command from reader/writer (see SNo.1 in Figure 7-1 Tunnel Mode Sequence) to the end of the response to the command from RFID to reader/writer (see SNo.8 in Figure 7-1 Tunnel Mode Sequence).

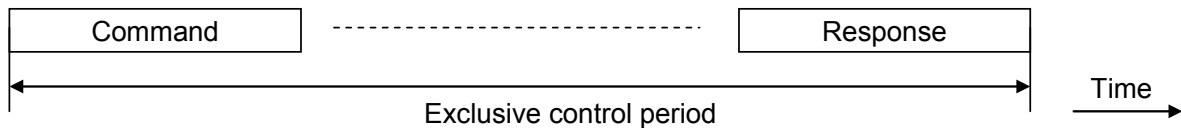

Figure 8-1 Exclusive Control Period

Table 8-1 shows the operations in exclusive control period for each operation mode. Illegular cases that are not generated normally are indicated with parenthesis.

The RFID responds with BUSY to a command from the host if the slave address is identified. It also responds with BUSY for unimplemented command.

In tunnel mode, the RFID operation differs between before and after IRQ output following the reception of a tunnel mode command from reader/writer.

Table 8-1 Operation during Exclusive Control (Irregular Case in Parenthesis)

Current operation mode	Receive command		Operation to a receive command
	Operation mode	From	
RF communication mode	(RF communication mode)	(R/W)	(No response)
	Serial communication mode	Host	Responds with BUSY.
	(Tunnel mode)	(R/W)	(No response)
	Tunnel mode	(Host)	(Responds with BUSY.)
Serial communication mode	RF communication mode	R/W	No response
	Serial communication mode	Host	Responds with BUSY (at reception during command processing).
	Tunnel mode	R/W	No response
	(Tunnel mode)	(Host)	(No response)
Tunnel mode	(RF communication mode)	(R/W)	(No response)
	Serial communication mode	Host	Responds with BUSY.
	(Tunnel mode)	(R/W)	(No response)
	Tunnel mode	Host	See 7.1 Tunnel Mode Sequence.

Figure 8-2 shows the detail of exclusive control in tunnel mode.

When the RFID receives a command from the host during tunnel mode command reception and before IRQ output, it sends a response with BUSY and then outputs IRQ.

When the RFID receives a command (other than QUERY) from the host after IRQ output, it responds with BUSY to the command.

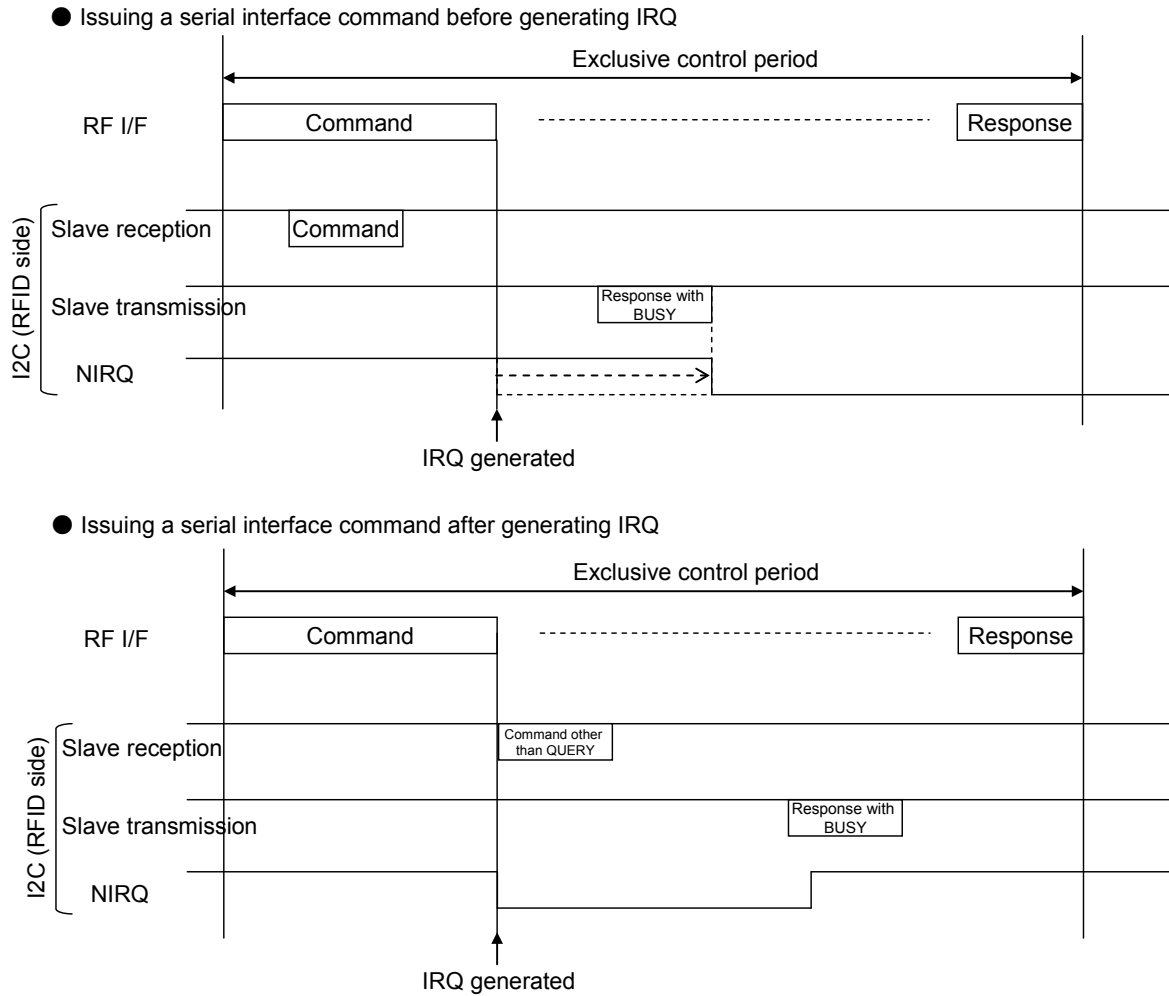

Figure 8-2 Exclusive Control in Tunnel Mode

8.2 State Transition Diagram in Operation Mode

Figure 8-3 shows the state transition diagram of this RFID in operation mode.

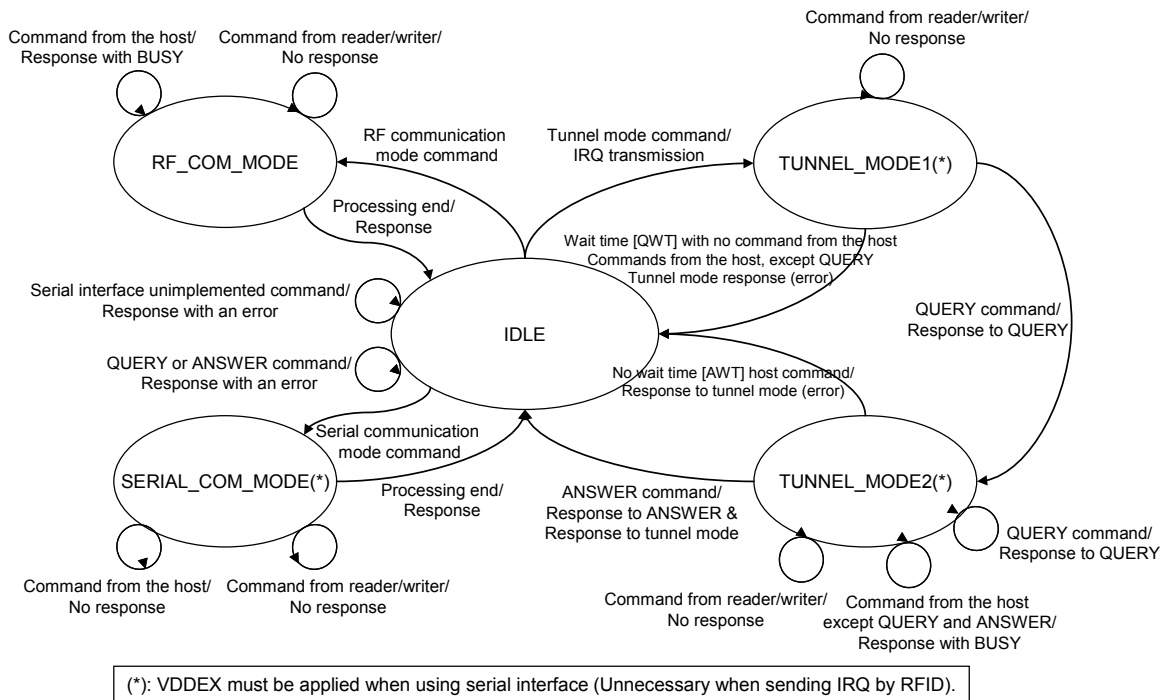
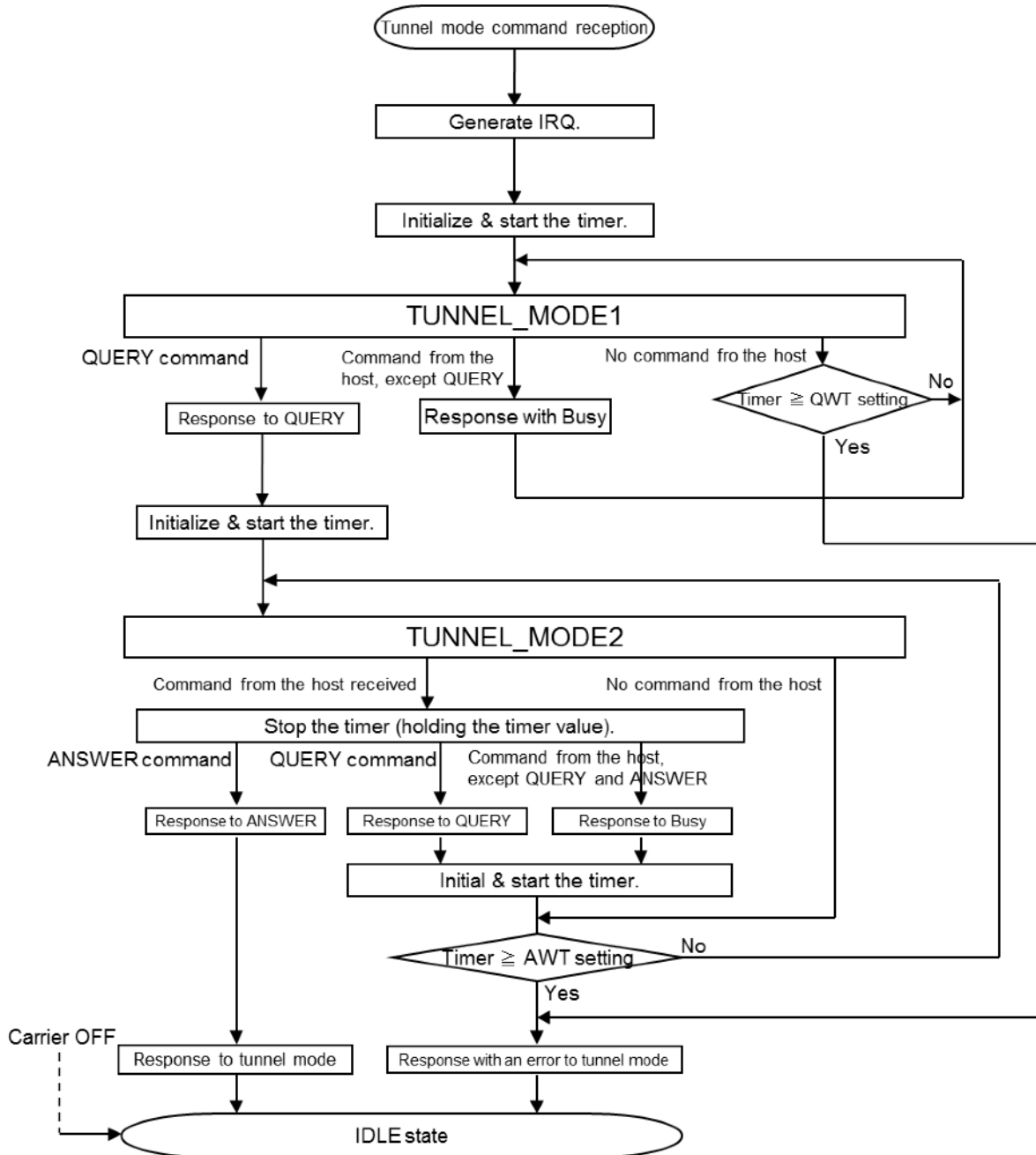

Figure 8-3 State Transition Diagram in Operation Mode

8.3 Flow Chart in Tunnel Mode

Figure 8-4 illustrates a flow chart for tunnel mode.



Regardless of the state after tunnel mode reception, a Carrier OFF causes the RFID to transition to IDLE state.

Figure 8-4 Flow Chart in Tunnel Mode

Chapter 9 Electrical characteristics

9

Attention

The technical information described in this document is intended only to show the main characteristics and application circuit examples of the product. No license is granted in and to any intellectual property right or other right owned by Panasonic Corporation or any other company. Therefore, no responsibility is assumed by our company as to the infringement upon any such right owned by any other company which may arise as a result of the use of technical information described in this document.

Use caution regarding the orientation of the LSI during use. Mounting of the LSI in an incorrect orientation may cause smoke or fire.

Structure	CMOS Type LSI with 4Kbit FeRAM
Application	Digital AV devices, Home Appliances, Portable devices, etc.
Function	Dual interface RFID

A. Absolute Maximum Ratings Note 1)

$V_{SS} = 0\text{ V}$

Item		Symbol	Rating	Unit
A1	Power supply <small>Note 2)</small>	V_{DDEX}	- 0.3 ~ + 4.6	V
A2		V_{DDA}	- 0.3 ~ + 4.6	V
A3	Voltage antenna terminals swing (VB Peak to peak) <small>Note3)</small>	V_{CBA}	30	V
A4	Input pin voltage (SDA,SCL,NIRQ)	V_I	- 0.3 ~ + 4.6	V
A5	Output current	I_O	+12	mA
A6	Storage temperature	T_{stg}	-40 ~ 85	°C
A7	Operating ambient temperature	T_{opr}	-20 ~ 85	°C

Note 1) Absolute Maximum Ratings are limit values not to destroy the chip and are not to guarantee operation.

Note 2) VDDA is generated internally and are not supplied externally.

Note 3) Definition of Voltage antenna terminals swing (V_{CBA})

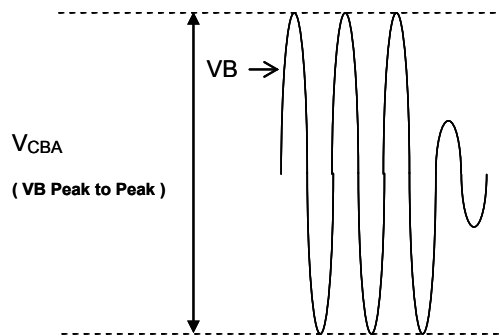

Notation for usage

1. Connect a 2.2 μ F smooth capacitor between VDDA and VSS pins as close as possible to the IC.

The accuracy of the capacitor including capacitance change with temperature must be within $\pm 30\%$.

2. Connect a 2.2 μ F (0.1 μ F \sim 2.2 μ F at VDDEX $<$ 2.5V) smooth capacitor between VDDEX and VSS pins as close as possible to the IC.

The accuracy of the capacitor including capacitance change with temperature must be within $\pm 30\%$.

3. In case of VDDEX=2.5V \sim 3.6V, connect a 200 Ω resistor at VDDEX pin as shown Fig5.

B. Operating Conditions

$T_a = -20\text{ }^\circ\text{C} \sim 85\text{ }^\circ\text{C}, V_{SS} = 0\text{ V}$

Item		Symbol	Conditions	Limits			Unit
				Min	Typ	Max	
B1	Supply voltage VDDEX	V_{DDEX}		1.7		3.6	V

Reference

$T_a = -20\text{ }^\circ\text{C} \sim 85\text{ }^\circ\text{C}, V_{SS} = 0\text{ V}$

Item		Symbol	Conditions	Limits			Unit
				Min	Typ	Max	
B2	VDDA voltage	V_{DDA}		1.65	1.8	3.6	V

C. Electric Characteristics

DC Characteristics

Ta = -20 °C ~ 85 °C, V_{SS} = 0 V

Item	Symbol	Conditions	Limits			Unit	
			Min	Typ	Max		
C1	Operating current on VDDEX	I _{DDEX}	VDDEX=3.3V	-	250	500	μA

Reference

Ta = -20 °C ~ 85 °C, V_{SS} = 0 V

Item	Symbol	Conditions	Limits			Unit	
			Min	Typ	Max		
C2	Operating current on VDDA	I _{DDA}	V _{DDA} = 1.8 V With 13.56 MHz RF input between VA and VB	-	220	400	μA

Note5) "C2" is the reference specification which is used at LSI manufacturing process to test RF communication characteristics.

I/O terminal characteristics

Ta = -20 °C ~ 85 °C, V_{SS} = 0 V

Item	Symbol	Condition	Limits			Unit
			Min	Typ	Max	

Input/Output pin : SDA, SCL

C3	Input voltage high level	V _{IH1}		0.7 × V _{DDEX}	-	V _{DDEX}	V
C4	Input voltage low level	V _{IL1}		0	-	0.3 × V _{DDEX}	V
C5	Input leakage current	I _{LK1}		- 10	0.02	+ 10	μA
C6	Output voltage low level (SDA)	I _{LK1}	V _{DDEX} =3.3 V, I _{OL} =4.0 mA	-	-	0.4	V

Output pin : NIRQ

C7	Output leakage current	I _{LK2}		- 10	0.02	+ 10	μA
C8	Output voltage low level	V _{OL2}	V _{DDEX} =3.3 V, I _{OL} =4.0 mA	-	-	0.4	V

Reference information

As a reference of pull-up resistor connected to the open-drain type terminals, SDA, SCL and NIRQ, 3.3Kohm resistors are used in our evaluation. Please adjust the resistance value considering the communication speed, capacitive loads and other factors.

Input capacitance

$V_{SS} = 0\text{ V}$

Item		Symbol	Condition	Limits			Unit
				Min	Typ	Max	
C9	Capacitance between antenna terminals (VA-VB)	C_I	$T_a = 25\text{ }^\circ\text{C}$ 13.56 MHz, amplitude 1V(RMS) with bias of 2V	13.5	15.5	17.5	pF

Load switch

$T_a = -20\text{ }^\circ\text{C} \sim 85\text{ }^\circ\text{C}$, $V_{SS} = 0\text{ V}$

Item		Symbol	Condition	Limits			Unit
				Min	Typ	Max	
C10	Load switch resistance	R_{LD}	VA-VB	90	150	210	Ω

D. AC characteristics

I2C interface

$T_a = -20\text{ }^\circ\text{C} \sim 85\text{ }^\circ\text{C}, V_{SS} = 0\text{ V}$

Item	Symbol	Limits			Unit	
		Min	Typ	Max		
D1	SCL clock frequency	F_{SCL}	20		100	kHz
D2	Hold time of Repeated-START condition	$T_{HD;STA}$	4.0			$\mu\text{ s}$
D3	SCL clock low period	T_{LOW}	4.7			$\mu\text{ s}$
D4	SCL clock high period	T_{HIGH}	4.0			$\mu\text{ s}$
D5	Setup time of Repeated-START condition	$T_{SU;STA}$	4.7			$\mu\text{ s}$
D6	SDA hold time	$T_{HD;DAT}$	0.0		3.45	$\mu\text{ s}$
D7	SDA setup time	$T_{SU;DAT}$	250			ns
D8	Setup time of STOP condition	$T_{SU;STO}$	4.0			$\mu\text{ s}$
D9	Period between STOP condition and START condition	T_{BUF}	4.7			$\mu\text{ s}$

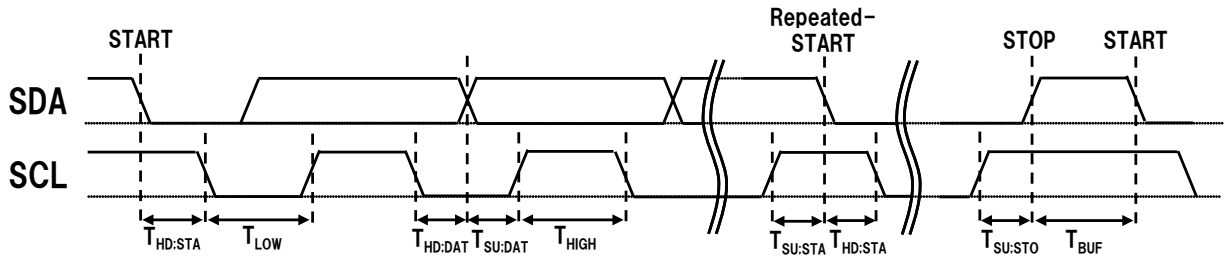
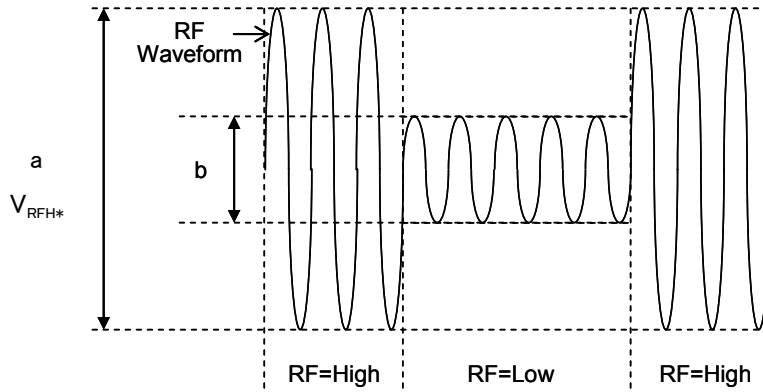

Fig.1

RF interface

Ta = -20 °C ~ 85 °C, V_{SS} = 0 V

Item	Symbol	Condition	Limits			Unit
			Min	Typ	Max	
D10	V _{RFH1}	RF 13.56 MHz	4.5	-	21	V
D11	m	JISX6319-4 RF interface specification Communication rate of 212kbps	4.0	-	14	%



Modulation Factor $m = \frac{a - b}{a + b}$

The RF waveform is measured with a calibration coil specified in ISO/IEC 10373-6.

Fig.2

E. Boot of power supply

Ta = -20 °C ~ 85 °C, V_{SS} = 0 V

Item	Symbol	Condition	Limits			Unit	
			Min	Typ	Max		
E1	VDDEX boot time to be ready to receive command	t _{BOOT}	Note 7)	-	-	3	ms
E2	VDDEX low pulse period	t _{PLW}	Note 7)	3	-	-	ms

Note 7) VDDEX-VSS decoupling capacitor is 0.1 μF and VDDD-VSS decoupling capacitor is 0.1 μF.

Note 8) When it turn OFF a VDD power supply, make VDDEX less than 0.3V.

Host access enable after T_{BOOT} time passed on Power up.

Host access is finished before Power down.

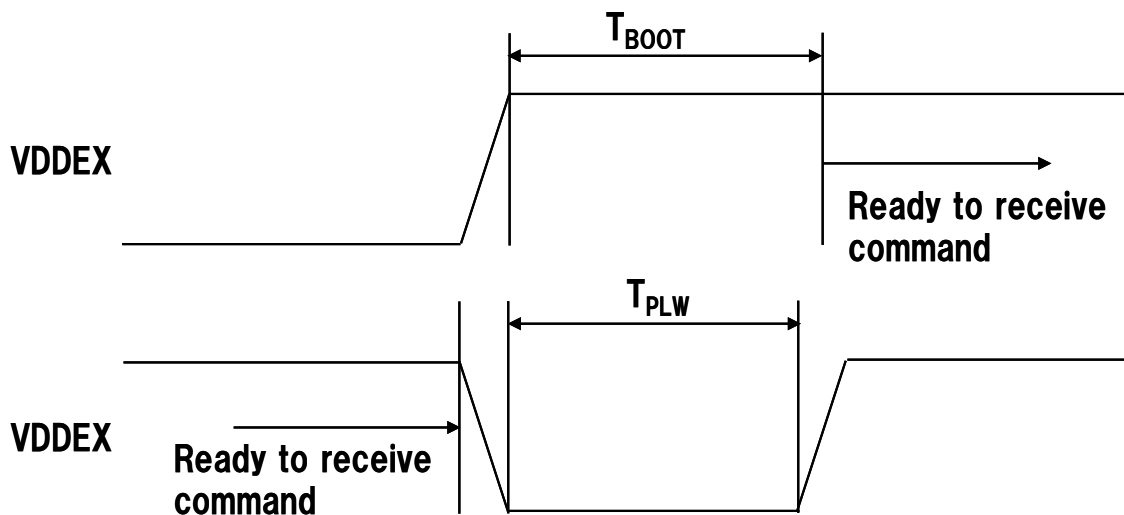

Fig.3

Revision History

Revised on July 15, 2013

Purpose	Version 0.1a			Version x.x		
	Page	Section	Comments	Page	Section	Comments

Revised on Aug 28, 2013

Purpose	Version 0.1			Version 1.0		
	Page	Section	Comments	Page	Section	Comments
						Rev. change
Modify	All pages		Figure/Table No.	All Pages		Figure/Table No. modify

Revised on Sep 30, 2013

Purpose	Version 1.0			Version 1.1		
	Page	Section	Comments	Page	Section	Comments
Modify	P24	Section3	Table3-1	P24	Section3	Table3-1 modify

Revised on Oct.09, 2013

Purpose	Version 1.1			Version 1.2		
	Page	Section	Comments	Page	Section	Comments
Modify	P50	Table4-10	Physical adr 0x0003 to 0x0004 Value : 0x0018 Supplement : --	P50	Table4-10	Physical adr 0x0003 to 0x0004 Value : 0x0017 Supplement : (Note:)
Add	P50	--	--	P50	--	Note:

Revised on Apr.15, 2014

Purpose	Version 1.2			Version 1.3		
	Page	Section	Comments	Page	Section	Comments
Modify	P40	L6	~the number is 13 for plaintext (unencrypted) ~	P40	L6	~the number is 15 for plaintext (unencrypted) ~
Modify	P80	Table5-4	0x09 Tunnel Mode error	P80	Table5-4	0x08 Tunnel Mode error
Modify	P84	--	5.2.5.3 RREG • Data Field Bit7 Reserved(Fixed0)	P84	--	5.2.5.3 RREG • Data Field Bit7 Reserved(Indifinite)
Add	P84	--	5.2.5.3 RREG • Data Field Remarks	P84	--	5.2.5.3 RREG • Data Field Remarks: The output of this bit takes either "0" or "1".

Purpose	Version 1.2			Version 1.3		
	Page	Section	Comments	Page	Section	Comments
Modify	P97	L1	The time sequence(QRTRY=1) for timeout	P97	L1	The time sequence for timeout

Revised on Sep 05, 2014

Purpose	Version 1.3			Version 1.31		
	Page	Section	Comments	Page	Section	Comments
Modify	P28	■IRQSEL	~RF response transmission is completed ~	P28	■IRQSEL	~RF response before transmission ~
Modify	P28	Table3-13	~RF response transmission is completed ~	P28	Table3-13	~RF response before transmission ~
Modify	P90	-	<ul style="list-style-type: none"> RF communication detect interrupt ~RF response transmission is completed ~	P90	-	<ul style="list-style-type: none"> RF communication detect interrupt ~RF response before transmission ~
Add	-	-	-	P90	Last	Add (Note:)
Modify	P98	7.3.3.1	A timeout time is the longer of QWT~	P98	7.3.3.1	A timeout time is QWT setting time.
Modify	P113	Fig8-4	Re-Start the timer	P113	Fig8-4	Initial Start the timer

Revised on Feb 24, 2015

Purpose	Version 1.31			Version 1.4		
	Page	Section	Comments	Page	Section	Comments
Add	---	---	---	P115	---	Chapter 9 Electrical characteristics

Request for your special attention and precautions in using the technical information and semiconductors described in this book

- (1) If any of the products or technical information described in this book is to be exported or provided to non-residents, the laws and regulations of the exporting country, especially, those with regard to security export control, must be observed.
- (2) The technical information described in this book is intended only to show the main characteristics and application circuit examples of the products. No license is granted in and to any intellectual property right or other right owned by Panasonic Corporation, Nuvoton Technology Corporation Japan or any other company. Therefore, no responsibility is assumed by our company as to the infringement upon any such right owned by any other company which may arise as a result of the use of technical information de-scribed in this book.
- (3) The products described in this book are intended to be used for general applications (such as office equipment, communications equipment, measuring instruments and household appliances), or for specific applications as expressly stated in this book.
Please consult with our sales staff in advance for information on the following applications, moreover please exchange documents separately on terms of use etc.: Special applications (such as for in-vehicle equipment, airplanes, aerospace, automotive equipment, traffic signaling equipment, combustion equipment, medical equipment and safety devices) in which exceptional quality and reliability are required, or if the failure or malfunction of the products may directly jeopardize life or harm the human body.
Unless exchanging documents on terms of use etc. in advance, it is to be understood that our company shall not be held responsible for any damage incurred as a result of or in connection with your using the products described in this book for any special application.
- (4) The products and product specifications described in this book are subject to change without notice for modification and/or improvement. At the final stage of your design, purchasing, or use of the products, therefore, ask for the most up-to-date Product Standards in advance to make sure that the latest specifications satisfy your requirements.
- (5) When designing your equipment, comply with the range of absolute maximum rating and the guaranteed operating conditions (operating power supply voltage and operating environment etc.). Especially, please be careful not to exceed the range of absolute maximum rating on the transient state, such as power-on, power-off and mode-switching. Otherwise, we will not be liable for any defect which may arise later in your equipment.
Even when the products are used within the guaranteed values, take into the consideration of incidence of break down and failure mode, possible to occur to semiconductor products. Measures on the systems such as redundant design, arresting the spread of fire or preventing glitch are recommended in order to prevent physical injury, fire, social damages, for example, by using the products.
- (6) Comply with the instructions for use in order to prevent breakdown and characteristics change due to external factors (ESD, EOS, thermal stress and mechanical stress) at the time of handling, mounting or at customer's process. We do not guarantee quality for disassembled products or the product re-mounted after removing from the mounting board.
When using products for which damp-proof packing is required, satisfy the conditions, such as shelf life and the elapsed time since first opening the packages.
- (7) When reselling products described in this book to other companies without our permission and receiving any claim of request from the resale destination, please understand that customers will bear the burden.
- (8) This book may be not reprinted or reproduced whether wholly or partially, without the prior written permission of our company.