

# 320 W multichannel high-power LED driver (using ICL5102 + ILD8150) engineering report

## About this document



### Scope and purpose

This document contains the specification and measurement results of the Infineon 320 W high-power (HP) LED driver with four channels of constant current (CC) output. This four-channel LED driver is composed of the ICL5102 320 W constant voltage (CV) reference board and four ILD8150 high-side DC-DC buck reference boards ([REF\\_ILD8150\\_DC\\_1.5A](#)):

- ICL5102 320 W form-factor board as the pre-stage of the LED driver with CV output, using the Infineon ICL5102 dual-stage PFC + half-bridge combo controller.
- ILD8150 100 W form-factor board as the end-stage with CC output for direct connection to LED modules.

### Intended audience

This document is intended for anyone wishing to design HP AC-DC converters with more output channels for LED lighting.

## Table of contents

<b>About this document</b> .....	<b>1</b>
<b>Table of contents</b> .....	<b>1</b>
<b>1 Introduction</b> .....	<b>2</b>
<b>2 Design features</b> .....	<b>5</b>
<b>3 Design specification</b> .....	<b>6</b>
<b>4 Schematic</b> .....	<b>7</b>
<b>5 PCB layout</b> .....	<b>9</b>
<b>6 320 W HP LED driver with four-channel measurement results</b> .....	<b>10</b>
6.1 Performance .....	10
6.2 Time-to-light delay .....	19
6.3 Standby power consumption .....	20
<b>7 ICL5102 320 W reference board standalone measurement results</b> .....	<b>21</b>
7.1 Performance .....	21
7.2 Line current harmonics measurement .....	25
7.3 Start-up delay .....	26
7.4 Standby power consumption .....	27
7.5 EMI performance .....	28
7.6 Thermal measurement .....	29
<b>8 BOM</b> .....	<b>31</b>
<b>9 Transformers specification</b> .....	<b>35</b>
<b>Revision history</b> .....	<b>37</b>

## Introduction

### 1 Introduction

The Infineon 320 W LED driver with four CC output channels is intended to show the benefits of designing multichannel HP LED drivers using Infineon controller ICs **ICL5102** and **ILD8150**.

ICL5102 is a PFC + half-bridge combo controller with the following features:

- High system (PFC + half-bridge) efficiency up to 95 percent by resonant topology
- Excellent input power quality with high power factor (PF) and low total harmonic distortion (THD)
- High robustness against surge and environmental stress due to high-side driver with coreless transformer

ILD8150 is a DC-DC high-side buck controller with the following features:

- Wide input voltage range from 8 to 80 V with output current up to 1.5 A
- Integrated high-side MOSFET with up to 2 MHz switching frequency
- Hybrid (analog + pulse width modulation/PWM) output dimming

The four-channel 320 W LED driver is composed of the ICL5102 320 W CV reference board and four ILD8150 high-side DC-DC buck reference boards, as follows:

- The ICL5102 320 W reference design is an AC-DC converter with CV output, which has a universal input of 90 to 305 V AC. The output voltage is a constant 73.5 V DC with a wide load range of 0 to 4.35 A. There are four output connectors intended for easy connection to the ILD8150 reference boards.

The 320 W reference design is ready for evaluation after correct setup. Please connect the AC input and DC output as shown in **Figure 1**.



**Figure 1** ICL5102 320 W CV reference board – top side



**Figure 2** ICL5102 320 W CV reference board – bottom side

# 320 W multichannel high-power LED driver (using ICL5102 + ILD8150) engineering report



## Introduction

- The ILD8150 100 W reference design is a DC-DC high-side buck CC LED driver, as shown in **Figure 3**. It has a wide input voltage range from 3 to 78 V and output current up to 1.5 A. There are two board variations, requiring a trade-off between system size and power efficiency. The comparison is shown in **Table 1**.

**Table 1** ILD8150 boards comparison

Board name	REF_ILD8150_DC_1.5A	REF_ILD8150_DC_1.5A_SMD
Inductor value	860 $\mu$ H, leaded	100 $\mu$ H, SMD
Switching frequency at the same input voltage and output power	Lower	Higher
Inductor size	Bigger	Smaller
System size	Bigger	Smaller
IC temperature at the same input voltage and output power	Lower	Higher
System efficiency	Higher	Lower

For more information, please refer to [REF\\_ILD8150\\_DC\\_1.5A](#).

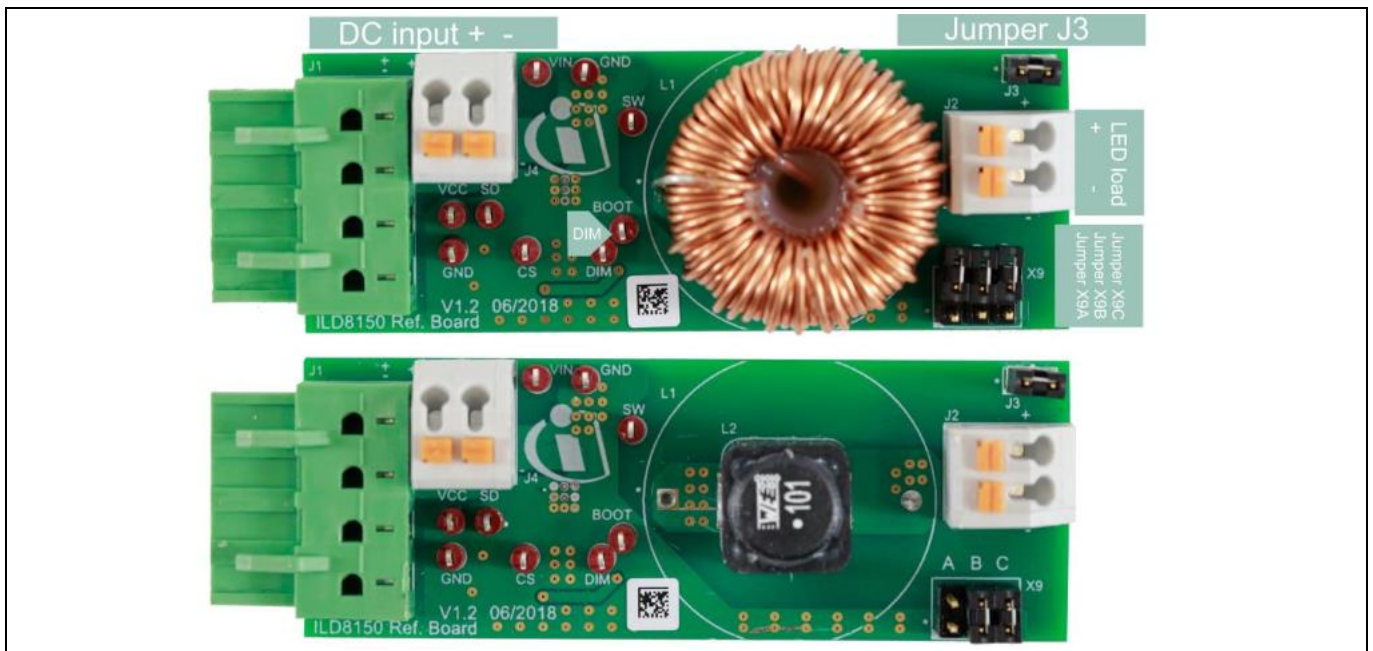

**Figure 3** ILD8150 100 W reference board

The assembled 320 W HP LED driver looks as shown in **Figure 4** after four ILD8150 reference boards have been connected to the ICL5102 320 W reference board.

## Introduction

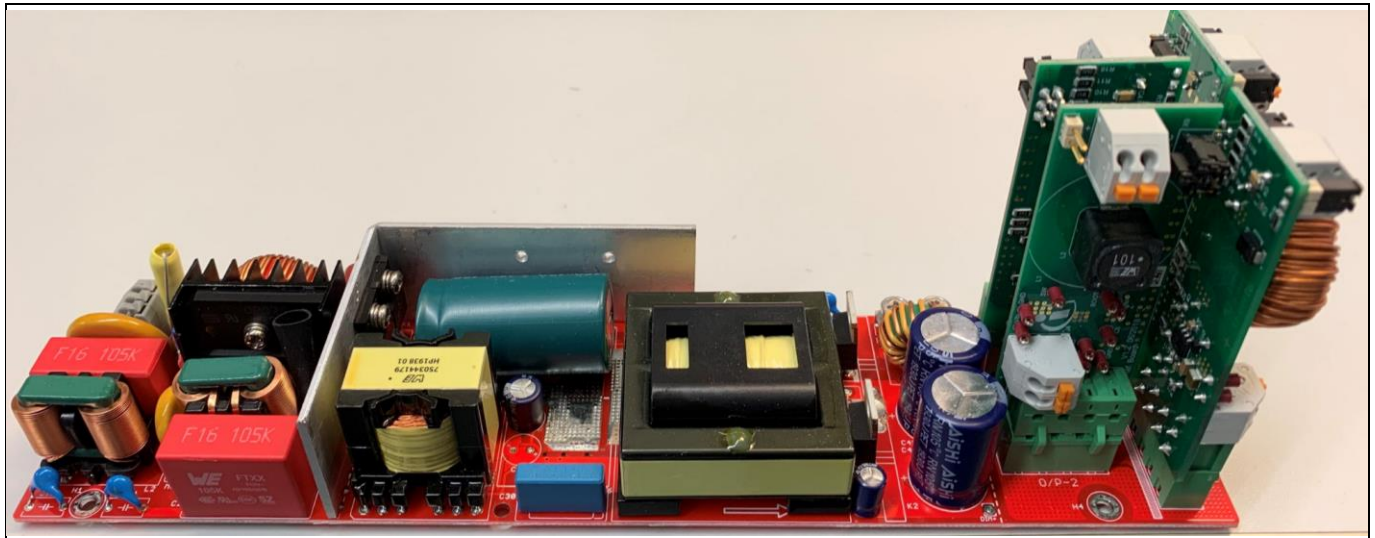

**Figure 4** 320 W high-power LED driver with four-channel output



## 2 Design features

The ICL5102 320 W reference board with CV output as AC-DC converter has the following design features:

- Dual-stage half-bridge (LLC) and separated power factor correction (PFC) with high-precision secondary side-controlled CV output.
- Excellent output voltage accuracy of typically +/-4 percent across universal input voltage range (90 to 305 V AC) and wide output current range (from 0 to 4.35 A).
- High PF (greater than 0.9) across universal input voltage range (90 to 305 V AC) and down to 50 percent of nominal load.
- Low input current total harmonic distortion (iTHD less than 15 percent) across universal input voltage range (90 to 305 V AC) and down to 30 percent of nominal load.
- Low bill of materials (BOM).

The ILD8150 100 W reference board with CC output as LED driver has following design features:

- Wide input voltage range from 8 to 80 V with maximum 1.5 A output current.
- Hybrid output dimming with PWM dimming frequency up to 20 kHz.
- Shut-down mode with low power consumption for dim-to-off.

### 3 Design specification

**Table 2** lists the electrical specification of the ICL5102 320 W AC-DC converter reference design.

**Table 2 Electrical specification**

Specification	Symbol	Value	Unit
AC input voltage range	$V_{IN\_AC}$	90 to 305	V AC
Nominal output voltage	$V_{OUT}$	73.5	V DC
Output current range	$I_{OUT}$	0 ~ 4.35	A
Total line and load regulation tolerance	–	Less than $\pm 4$	%
Efficiency ( $V_{IN}$ : 120 to 277 V AC, $V_{OUT}$ : 73.5 V DC, $I_{OUT}$ : 4.35 A)	$\eta$	Less than 94	%
Power factor ( $V_{IN}$ : 120 to 277 V AC +/-10 percent, $V_{OUT}$ : 73.5 V DC, greater than 50 percent load)	PF	Greater than 0.9	–
Input current total harmonic distortion ( $V_{IN}$ : 120 to 277 V AC +/-10 percent, $V_{OUT}$ : 73.5 V DC, greater than 30 percent load)	iTHD	Less than 15	%
Board dimensions without connectors to ILD8150 (L x B x H)	–	20 x 5.8 x 3	cm
Board dimensions with connectors to ILD8150 (L x B x H)	–	24.8 x 5.8 x 3	cm

**Table 3** lists the electrical specification of the ILD8150 100 W DC-DC buck LED driver reference design.

**Table 3 Electrical specification**

Specification	Symbol	Value	Unit
Input voltage range	$V_{IN}$	8 ~ 80	V DC
Output voltage range	$V_{OUT}$	3 ~ 71	V DC
Output current range	$I_{OUT}$	0 ~ 1.5	A
Nominal (undimmed) output current range	$I_{OUT\_MAX}$	1.5	A
Output current tolerance	–	Less than $\pm 3$	%
Efficiency	$\eta$	Less than 98	%
Board dimensions (L x B x H)	–	7.4 x 2.7 x 1.7	cm

## 4 Schematic

Figure 5 shows the complete schematic of the ICL5102 320 W reference design:

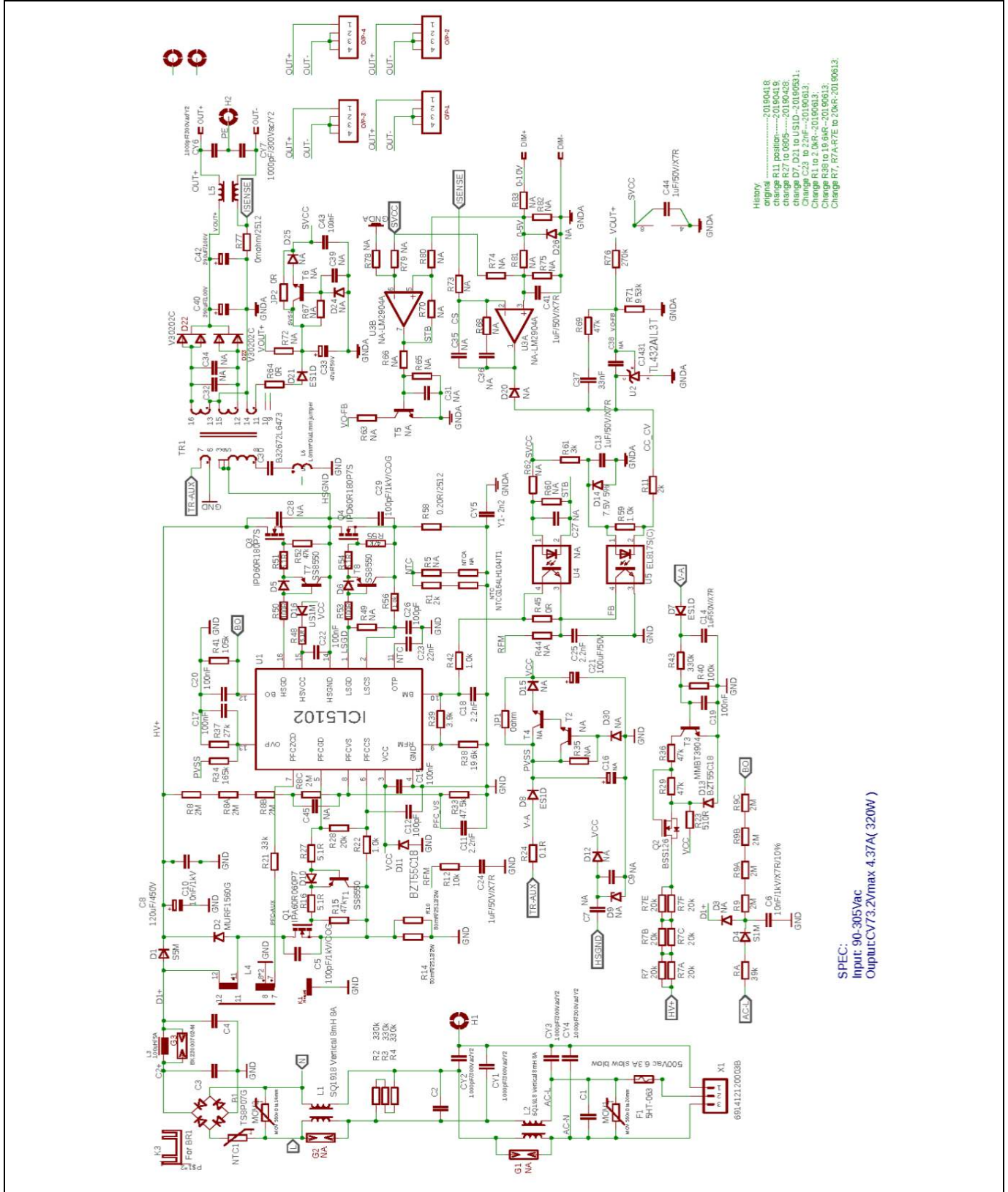

Figure 5 Schematic of the ICL5102 320 W reference design

# 320 W multichannel high-power LED driver (using ICL5102 + ILD8150) engineering report



## Schematic

Figure 6 shows the complete schematic of the ILD8150 100 W reference design:

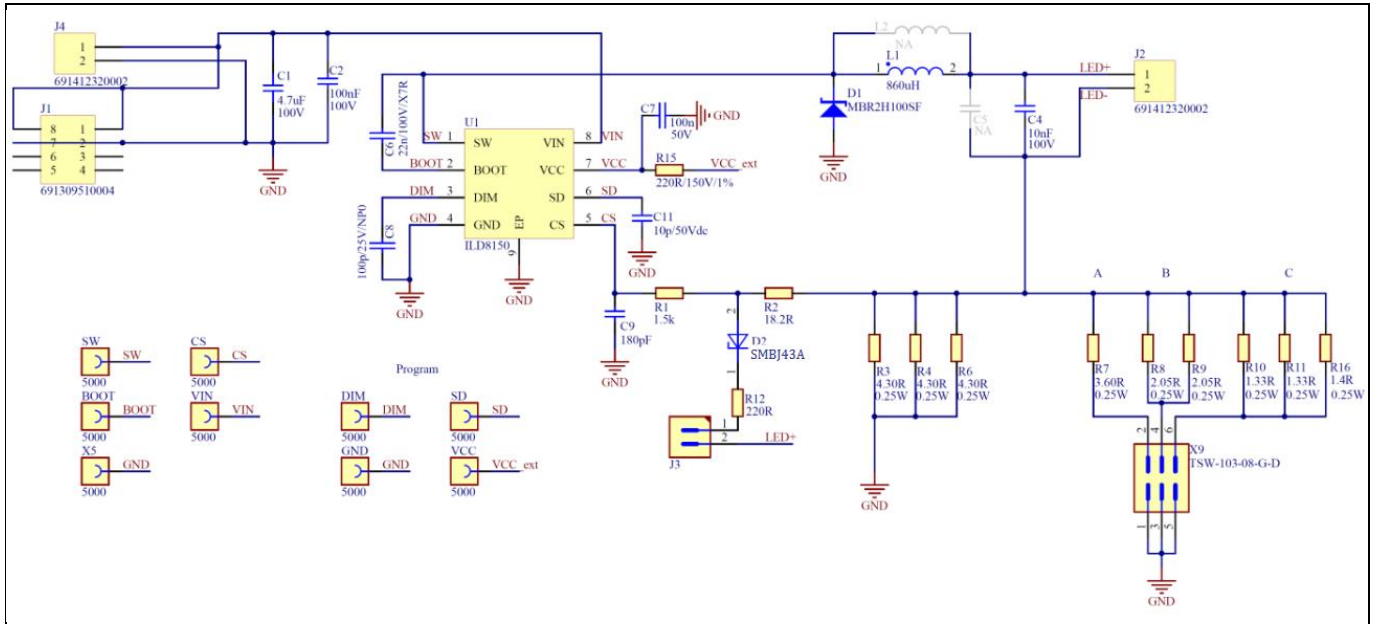

Figure 6 Schematic of the ILD8150 100 W reference design



## 5 PCB layout

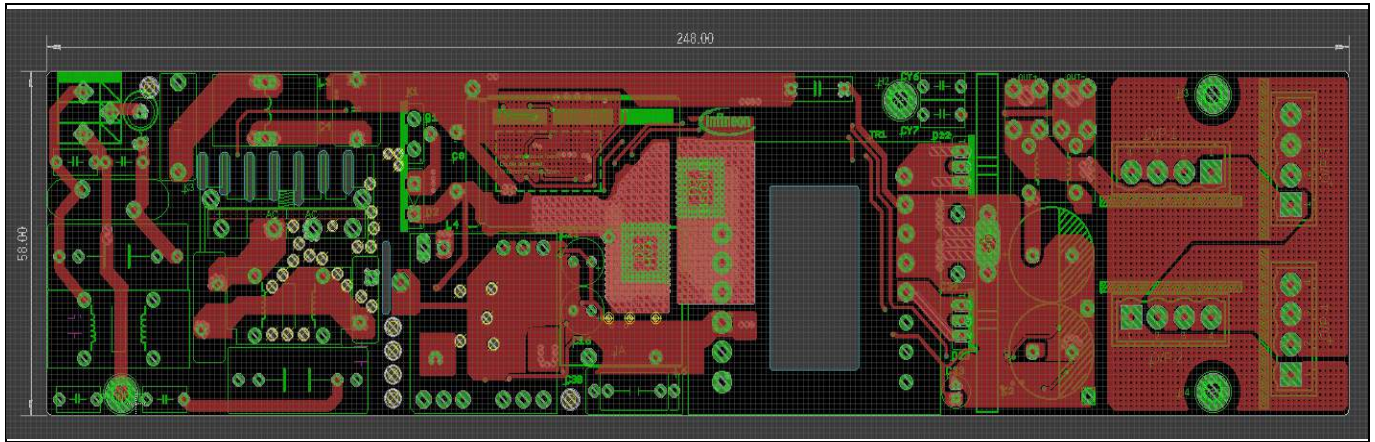

Figure 7 ICL5102 320 W reference design – PCB top side

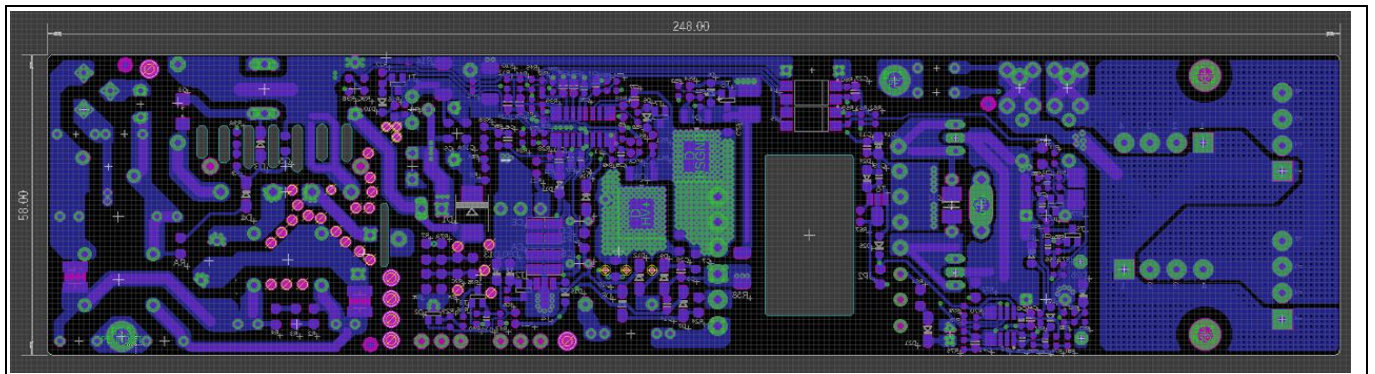

Figure 8 ICL5102 320 W reference design – PCB bottom side

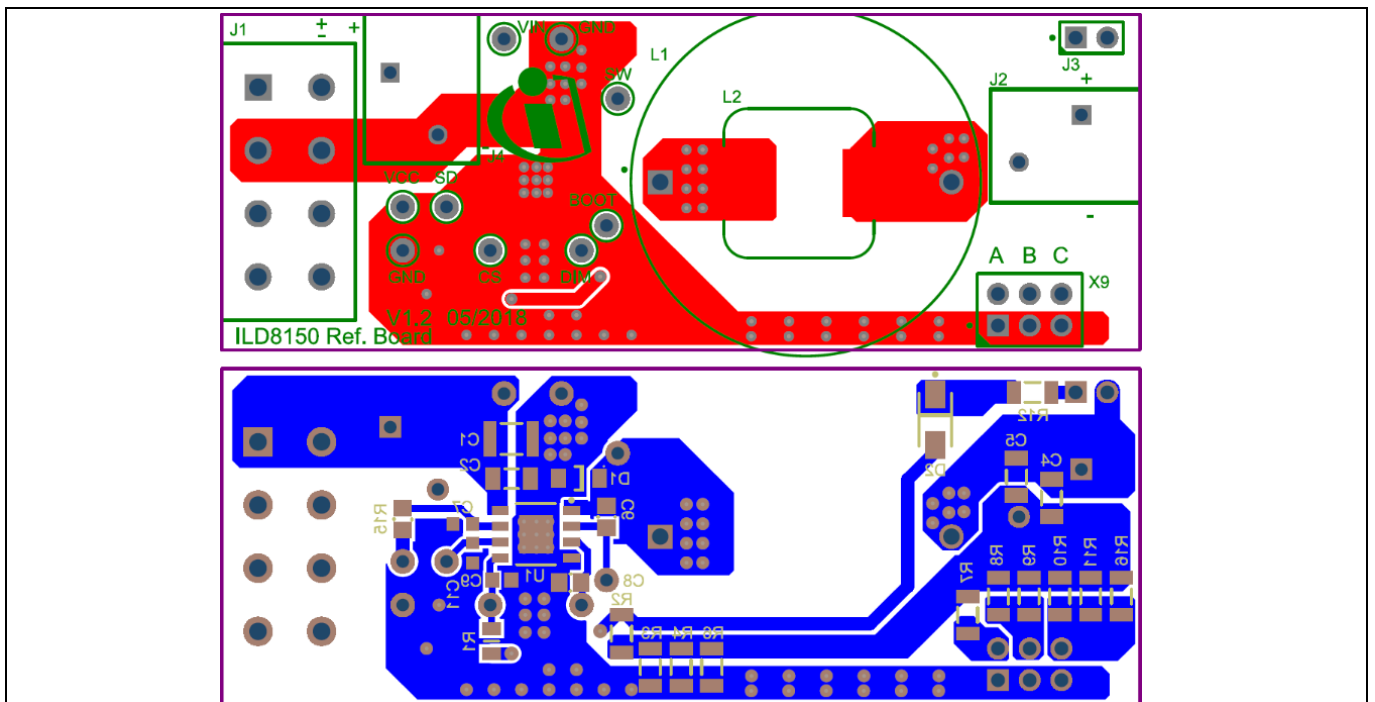

Figure 9 ILD8150 100 W reference design – PCB layout

## 6 320 W HP LED driver with four-channel measurement results

The measurement results shown in this chapter are achieved with following setup:

- 1 x ICL5102 320 W reference board with CV output, connected with:
- 2 x ILD8150 100 W reference boards with CC output (nominal 1.5 A undimmed) and 2 x ILD8150 100 W reference boards with CC output (nominal 1.1 A undimmed); they are dimmed synchronously with the same PWM signal
- 4 x high-brightness LED loads, each connected with an ILD8150 100 W reference board

For more measurement results related to the ICL5102 320 W reference board, please refer to the ICL5102 320 W reference board measurement results in chapter 7.

For more measurement results related to the ILD8150 100 W reference board, please refer to [the engineering report](#).

### 6.1 Performance

**Table 4 Measurement with 90 V AC input**

$V_{IN}$ (V AC)	$P_{IN}$ (W)	$V_{OUT}$ (V)		$I_{OUT}$ (A)		Dimming (%)	$P_{OUT}$ (W)	PF	THD (%)	$\eta$ (%)
90.14	359.6	Ch1	63.20	Ch1	1.04	100	316.73	0.998	4.6	88.07
		Ch2	64.25	Ch2	1.05					
		Ch3	60.60	Ch3	1.47					
		Ch4	64.70	Ch4	1.46					
89.83	262.3	Ch1	62.45	Ch1	0.76	75	232.84	0.998	3.8	88.57
		Ch2	63.91	Ch2	0.77					
		Ch3	59.90	Ch3	1.13					
		Ch4	64.47	Ch4	1.12					
89.95	168.2	Ch1	60.72	Ch1	0.48	50	150.25	0.996	4.1	89.33
		Ch2	62.77	Ch2	0.48					
		Ch3	58.48	Ch3	0.736					
		Ch4	63.46	Ch4	0.732					
89.93	98.92	Ch1	58.90	Ch1	0.27	30	85.69	0.992	4.3	86.6
		Ch2	61.23	Ch2	0.27					
		Ch3	56.95	Ch3	0.46					

# 320 W multichannel high-power LED driver (using ICL5102 + ILD8150) engineering report



## 320 W HP LED driver with four-channel measurement results

$V_{IN}$ (V AC)	$P_{IN}$ (W)	$V_{OUT}$ (V)		$I_{OUT}$ (A)		Dimming (%)	$P_{OUT}$ (W)	PF	THD (%)	$\eta$ (%)
		Ch4	62.19	Ch4	0.45					
89.97	67.48	Ch1	57.53	Ch1	0.17	20	55.55	-	-	82.3
		Ch2	59.87	Ch2	0.17					
		Ch3	55.86	Ch3	0.31					
		Ch4	61.21	Ch4	0.31					
90.00	38.70	Ch1	55.63	Ch1	0.09	10	27.98	-	-	72.3
		Ch2	57.90	Ch2	0.10					
		Ch3	53.68	Ch3	0.16					
		Ch4	58.71	Ch4	0.15					
90.02	24.31	Ch1	53.01	Ch1	0.05	5	13.40	-	-	55.1
		Ch2	55.26	Ch2	0.05					
		Ch3	50.85	Ch3	0.07					
		Ch4	55.61	Ch4	0.07					
90.04	12.61	Ch1	50.74	Ch1	0.01	1	2.55	-	-	20.7
		Ch2	52.82	Ch2	0.01					
		Ch3	48.41	Ch3	0.015					
		Ch4	52.86	Ch4	0.015					
90.04	10.80	Ch1	50.49	Ch1	0.005	0.46	1.02	-	-	9.43
		Ch2	52.56	Ch2	0.005					
		Ch3	48.18	Ch3	0.005					
		Ch4	52.54	Ch4	0.005					

# 320 W multichannel high-power LED driver (using ICL5102 + ILD8150) engineering report



## 320 W HP LED driver with four-channel measurement results

**Table 5 Measurement with 110 V AC input**

$V_{IN}$ (V AC)	$P_{IN}$ (W)	$V_{OUT}$ (V)		$I_{OUT}$ (A)		Dimming (%)	$P_{OUT}$ (W)	PF	THD (%)	$\eta$ (%)
110.1	353.42	Ch1	63.20	Ch1	1.04	100	316.73	0.998	3.8	89.62
		Ch2	64.25	Ch2	1.05					
		Ch3	60.60	Ch3	1.47					
		Ch4	64.70	Ch4	1.46					
109.9	257.17	Ch1	62.45	Ch1	0.76	75	232.84	0.997	3.9	90.34
		Ch2	63.91	Ch2	0.77					
		Ch3	59.90	Ch3	1.13					
		Ch4	64.47	Ch4	1.12					
109.88	168.12	Ch1	60.72	Ch1	0.48	50	150.25	0.994	4.3	89.37
		Ch2	62.77	Ch2	0.48					
		Ch3	58.48	Ch3	0.736					
		Ch4	63.46	Ch4	0.732					
109.95	98.96	Ch1	58.90	Ch1	0.27	30	85.69	0.984	4.5	86.63
		Ch2	61.23	Ch2	0.27					
		Ch3	56.95	Ch3	0.46					
		Ch4	62.19	Ch4	0.45					
109.98	68.19	Ch1	57.53	Ch1	0.17	20	55.55	-	-	81.46
		Ch2	59.87	Ch2	0.17					
		Ch3	55.86	Ch3	0.31					
		Ch4	61.21	Ch4	0.31					
110.01	40.71	Ch1	55.63	Ch1	0.09	10	27.98	-	-	68.75
		Ch2	57.90	Ch2	0.10					
		Ch3	53.68	Ch3	0.16					

# 320 W multichannel high-power LED driver (using ICL5102 + ILD8150) engineering report



## 320 W HP LED driver with four-channel measurement results

$V_{IN}$ (V AC)	$P_{IN}$ (W)	$V_{OUT}$ (V)		$I_{OUT}$ (A)		Dimming (%)	$P_{OUT}$ (W)	PF	THD (%)	$\eta$ (%)
		Ch4	58.71	Ch4	0.15					
110.03	27.51	Ch1	53.01	Ch1	0.05	5	13.40	-	-	48.7
		Ch2	55.26	Ch2	0.05					
		Ch3	50.85	Ch3	0.07					
		Ch4	55.61	Ch4	0.07					
110.04	16.51	Ch1	50.74	Ch1	0.01	1	2.55	-	-	15.48
		Ch2	52.82	Ch2	0.01					
		Ch3	48.41	Ch3	0.015					
		Ch4	52.86	Ch4	0.015					
110.04	13.98	Ch1	50.49	Ch1	0.005	0.46	1.02	-	-	7.29
		Ch2	52.56	Ch2	0.005					
		Ch3	48.18	Ch3	0.005					
		Ch4	52.54	Ch4	0.005					

**Table 6 Measurement with 230 V AC input**

$V_{IN}$ (V AC)	$P_{IN}$ (W)	$V_{OUT}$ (V)		$I_{OUT}$ (A)		Dimming (%)	$P_{OUT}$ (W)	PF	THD (%)	$\eta$ (%)
230.0	349.6	Ch1	63.20	Ch1	1.04	100	316.73	0.976	4.2	90.6
		Ch2	64.25	Ch2	1.05					
		Ch3	60.60	Ch3	1.47					
		Ch4	64.70	Ch4	1.46					
230.05	262.3	Ch1	62.45	Ch1	0.76	75	232.84	0.958	5.5	88.59
		Ch2	63.91	Ch2	0.77					
		Ch3	59.90	Ch3	1.13					
		Ch4	64.47	Ch4	1.12					



# 320 W multichannel high-power LED driver (using ICL5102 + ILD8150) engineering report



## 320 W HP LED driver with four-channel measurement results

$V_{IN}$ (V AC)	$P_{IN}$ (W)	$V_{OUT}$ (V)		$I_{OUT}$ (A)		Dimming (%)	$P_{OUT}$ (W)	PF	THD (%)	$\eta$ (%)
230.11	179.49	Ch1	60.72	Ch1	0.48	50	150.25	0.913	7.6	83.71
		Ch2	62.77	Ch2	0.48					
		Ch3	58.48	Ch3	0.736					
		Ch4	63.46	Ch4	0.732					
230.13	119.67	Ch1	58.90	Ch1	0.27	30	85.69	0.81	11.7	71.61
		Ch2	61.23	Ch2	0.27					
		Ch3	56.95	Ch3	0.46					
		Ch4	62.19	Ch4	0.45					
230.15	96.66	Ch1	57.53	Ch1	0.17	20	55.55	-	-	57.47
		Ch2	59.87	Ch2	0.17					
		Ch3	55.86	Ch3	0.31					
		Ch4	61.21	Ch4	0.31					
230.15	73.65	Ch1	55.63	Ch1	0.09	10	27.98	-	-	38.1
		Ch2	57.90	Ch2	0.10					
		Ch3	53.68	Ch3	0.16					
		Ch4	58.71	Ch4	0.15					
230.15	57.54	Ch1	53.01	Ch1	0.05	5	13.40	-	-	23.28
		Ch2	55.26	Ch2	0.05					
		Ch3	50.85	Ch3	0.07					
		Ch4	55.61	Ch4	0.07					
230.1	43.72	Ch1	50.74	Ch1	0.01	1	2.55	-	-	5.84
		Ch2	52.82	Ch2	0.01					
		Ch3	48.41	Ch3	0.015					
		Ch4	52.86	Ch4	0.015					

# 320 W multichannel high-power LED driver (using ICL5102 + ILD8150) engineering report



## 320 W HP LED driver with four-channel measurement results

$V_{IN}$ (V AC)	$P_{IN}$ (W)	$V_{OUT}$ (V)		$I_{OUT}$ (A)		Dimming (%)	$P_{OUT}$ (W)	PF	THD (%)	$\eta$ (%)
230.2	42.22	Ch1	50.49	Ch1	0.005	0.46	1.02	-	-	2.41
		Ch2	52.56	Ch2	0.005					
		Ch3	48.18	Ch3	0.005					
		Ch4	52.54	Ch4	0.005					

**Table 7 Measurement with 277 V AC input**

$V_{IN}$ (V AC)	$P_{IN}$ (W)	$V_{OUT}$ (V)		$I_{OUT}$ (A)		Dimming (%)	$P_{OUT}$ (W)	PF	THD (%)	$\eta$ (%)
277.04	357.38	Ch1	63.20	Ch1	1.04	100	316.73	0.956	5.9	88.63
		Ch2	64.25	Ch2	1.05					
		Ch3	60.60	Ch3	1.47					
		Ch4	64.70	Ch4	1.46					
277.09	271.55	Ch1	62.45	Ch1	0.76	75	232.84	0.919	7.2	85.56
		Ch2	63.91	Ch2	0.77					
		Ch3	59.90	Ch3	1.13					
		Ch4	64.47	Ch4	1.12					
277.12	196.76	Ch1	60.72	Ch1	0.48	50	150.25	0.84	11.98	76.37
		Ch2	62.77	Ch2	0.48					
		Ch3	58.48	Ch3	0.736					
		Ch4	63.46	Ch4	0.732					
277.12	138.56	Ch1	58.90	Ch1	0.27	30	85.69	0.68	17.6	61.85
		Ch2	61.23	Ch2	0.27					
		Ch3	56.95	Ch3	0.46					
		Ch4	62.19	Ch4	0.45					
277.06		Ch1	57.53	Ch1	0.17	20	55.55	-	-	47.74

# 320 W multichannel high-power LED driver (using ICL5102 + ILD8150) engineering report



## 320 W HP LED driver with four-channel measurement results

$V_{IN}$ (V AC)	$P_{IN}$ (W)	$V_{OUT}$ (V)		$I_{OUT}$ (A)		Dimming (%)	$P_{OUT}$ (W)	PF	THD (%)	$\eta$ (%)
		Ch2	59.87	Ch2	0.17					
		Ch3	55.86	Ch3	0.31					
		Ch4	61.21	Ch4	0.31					
277.18	85.93	Ch1	55.63	Ch1	0.09	10	27.98	-	-	32.57
		Ch2	57.90	Ch2	0.10					
		Ch3	53.68	Ch3	0.16					
		Ch4	58.71	Ch4	0.15					
277.18	72.07	Ch1	53.01	Ch1	0.05	5	13.40	-	-	18.59
		Ch2	55.26	Ch2	0.05					
		Ch3	50.85	Ch3	0.07					
		Ch4	55.61	Ch4	0.07					
277.07	60.96	Ch1	50.74	Ch1	0.01	1	2.55	-	-	4.19
		Ch2	52.82	Ch2	0.01					
		Ch3	48.41	Ch3	0.015					
		Ch4	52.86	Ch4	0.015					
277.18	58.21	Ch1	50.49	Ch1	0.005	0.46	1.02	-	-	1.75
		Ch2	52.56	Ch2	0.005					
		Ch3	48.18	Ch3	0.005					
		Ch4	52.54	Ch4	0.005					

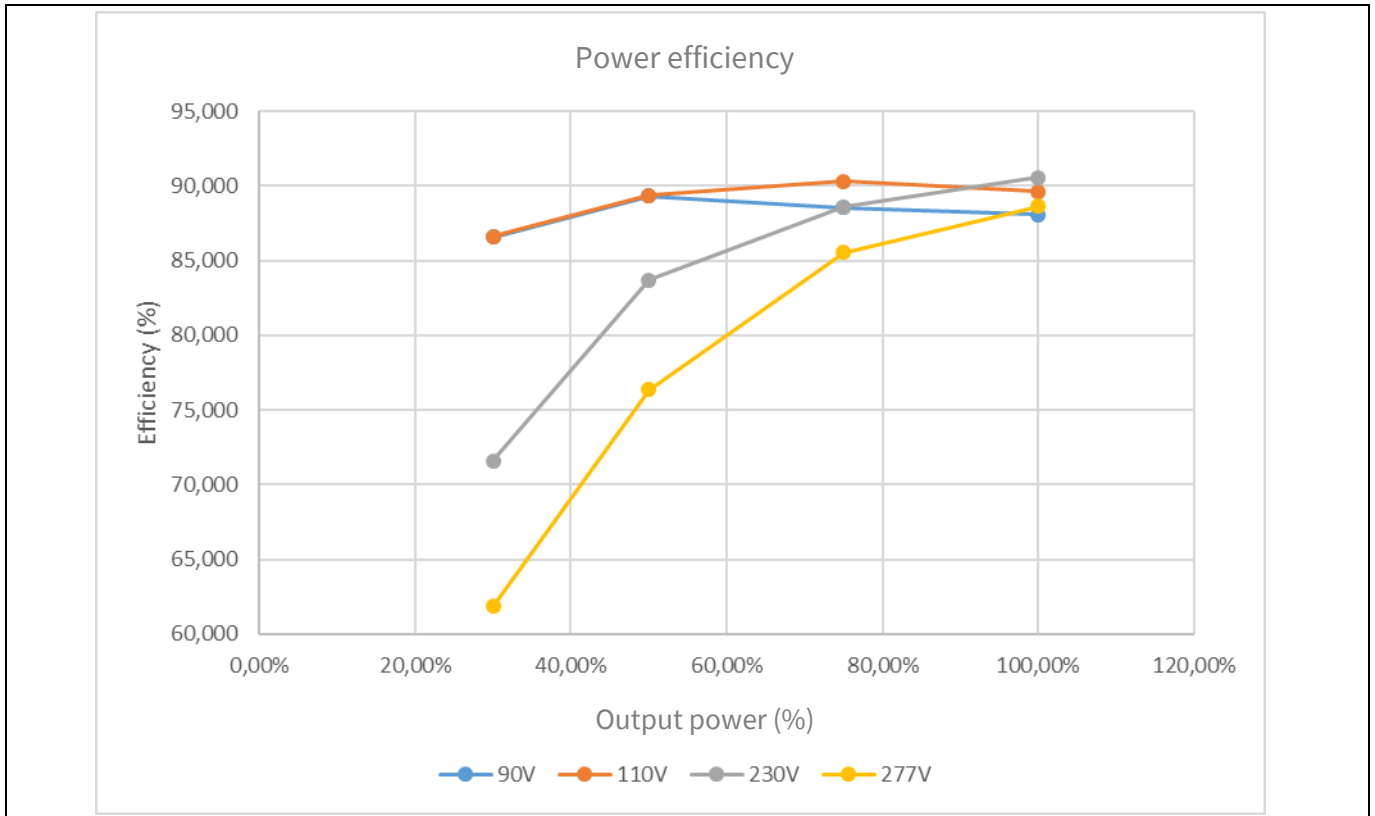

**Figure 10 320 W HP LED driver power efficiency**

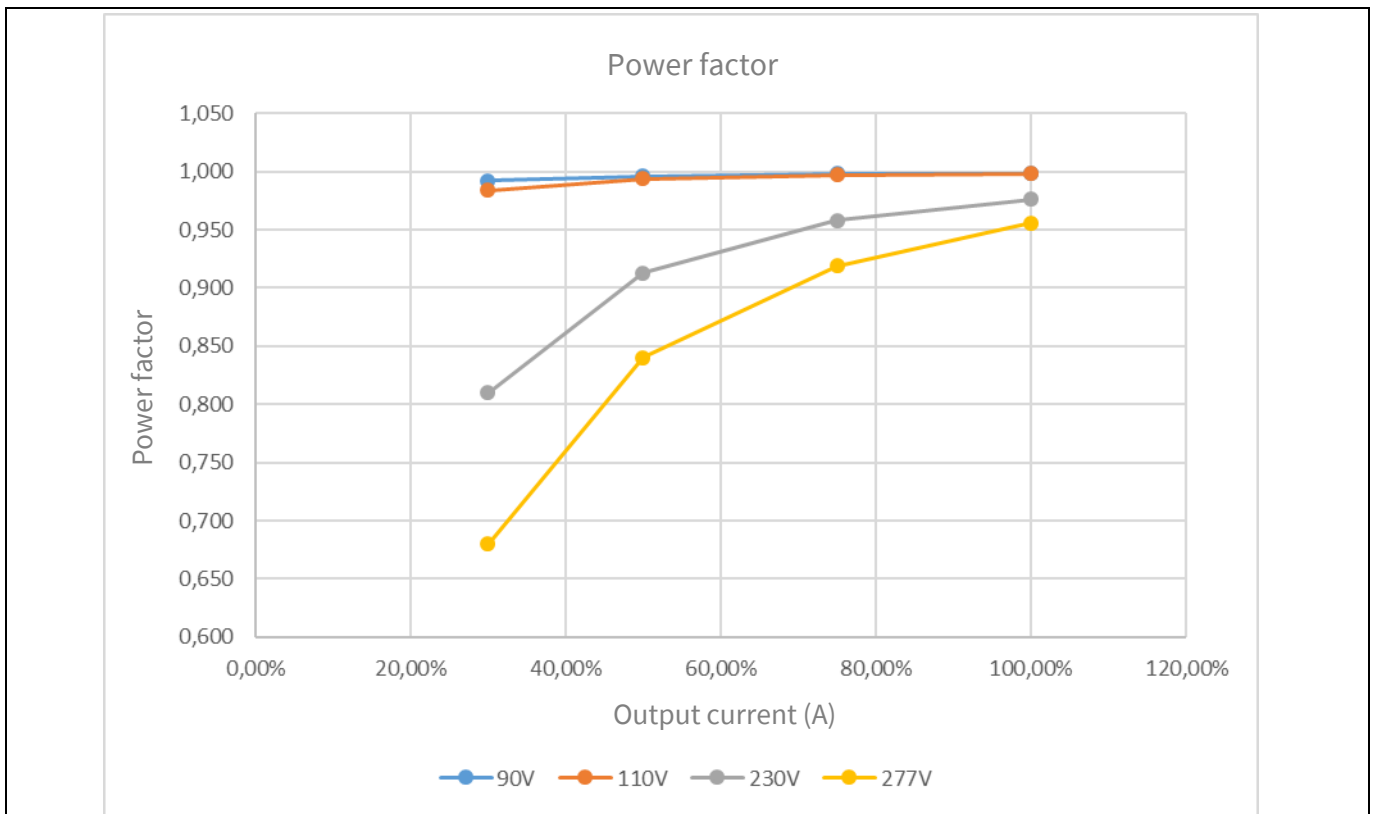

**Figure 11 320 W HP LED driver PF**

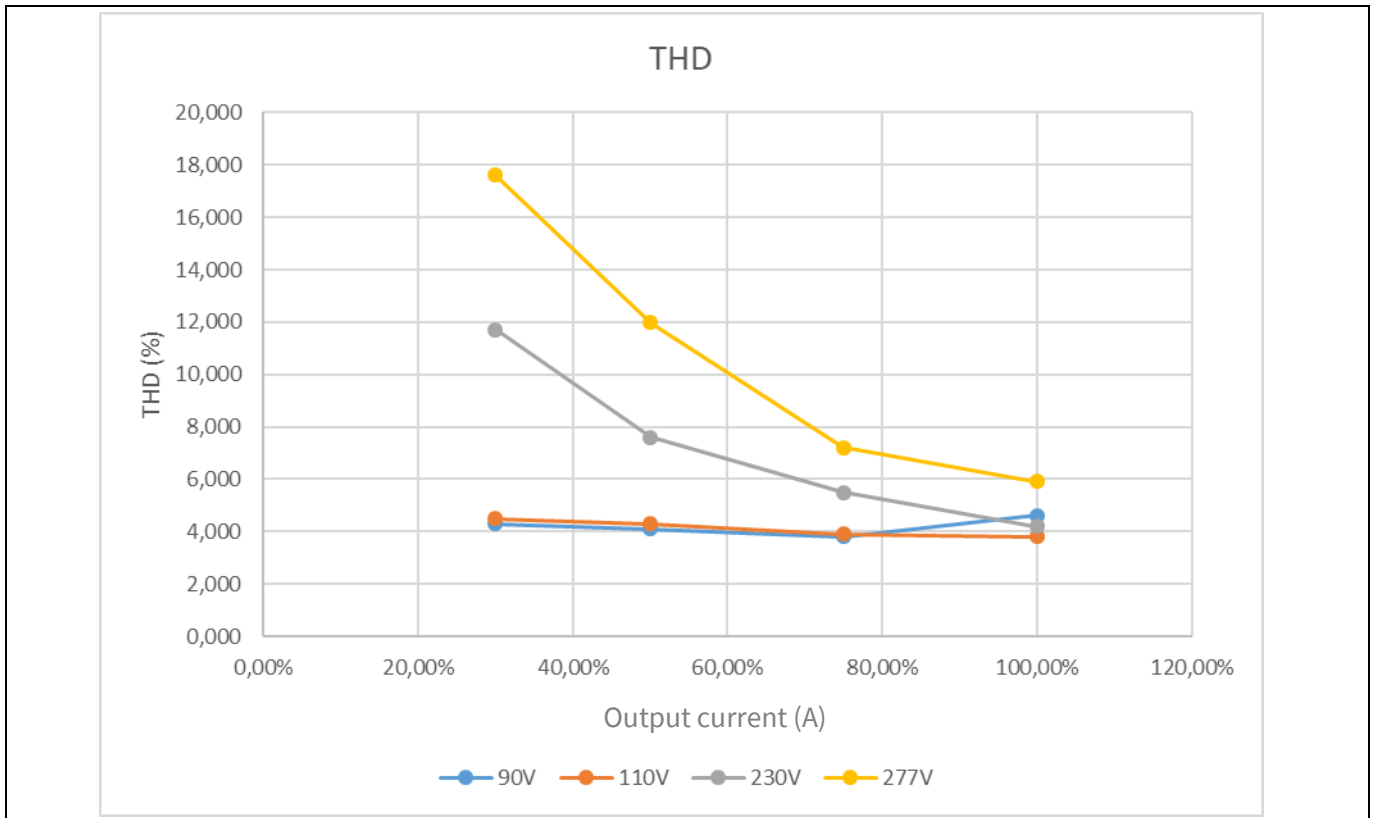

**Figure 12 320 W HP LED driver THD**

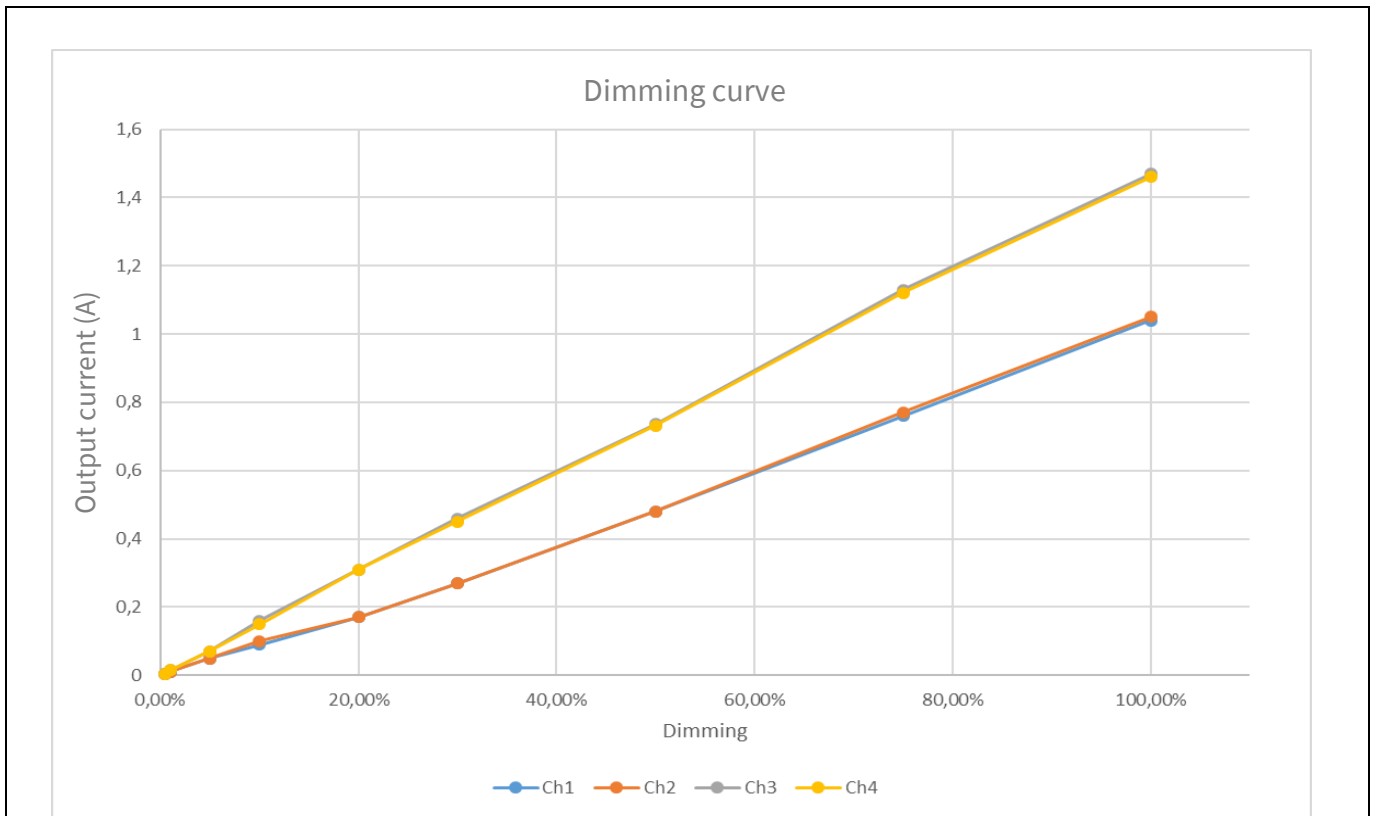

**Figure 13 320 W HP LED driver dimming curve**



**Attention:** *As the ILD8150 has a hybrid dimming function, which means from dimming level 12.5 percent to 0.5 percent, there is PWM dimming. So any input voltage ripple on ILD8150 could lead to output current ripple, which means optical flicker. To avoid this, please make sure the pre-stage ICL5102 with CV output will not enter burst mode in the light load condition. However, in the dim-to-off condition, burst mode is allowed to achieve low standby power. For more information, please refer to the ICL5102 and ILD8150 datasheet and design guide.*

## 6.2 Time-to-light delay

The time-to-light delay is measured with full load as follows:

**Table 8 Time-to-light delay**

Input	Time-to-light delay
90 V AC	0.48 s
110 V AC	0.29 s
230 V AC	0.18 s
277 V AC	0.15 s

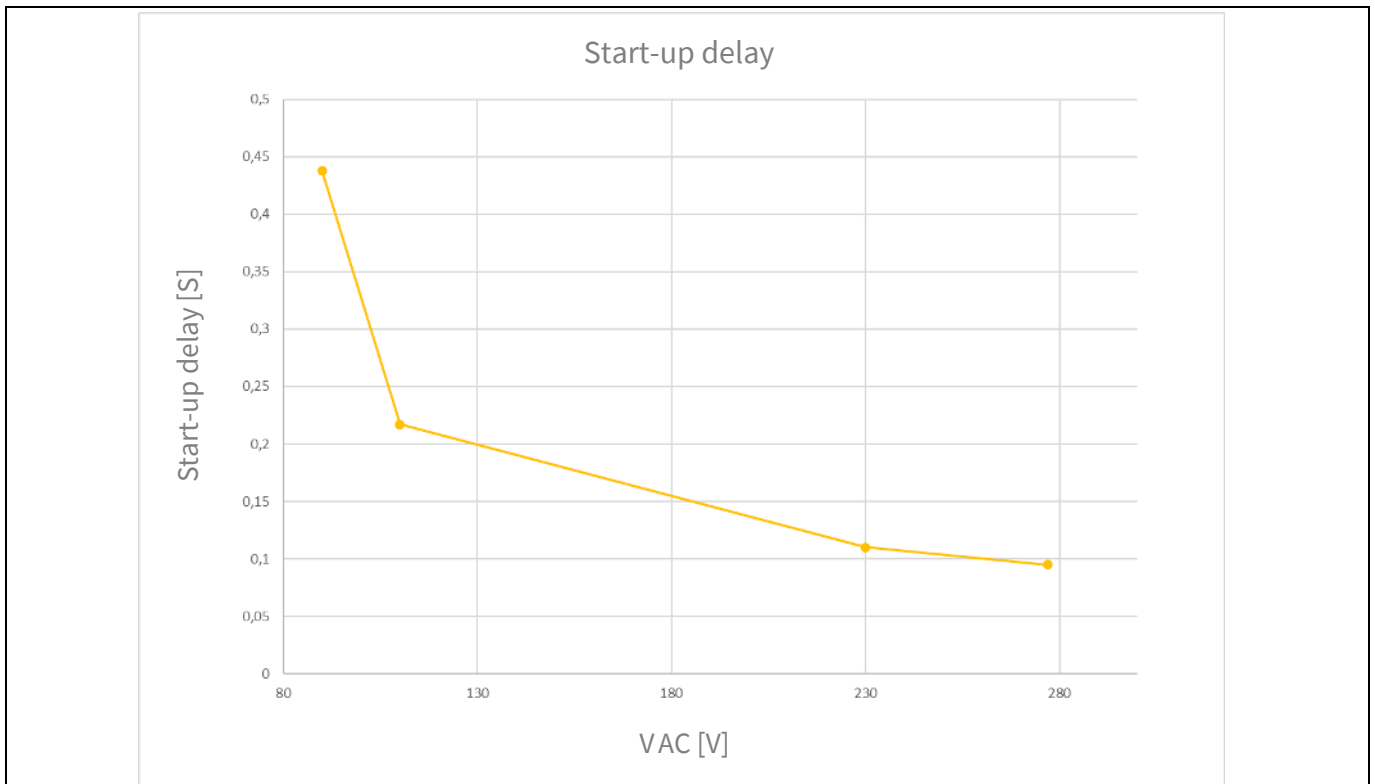

**Figure 14 320 W HP LED driver time-to-light delay at full load**

### 6.3 Standby power consumption

The standby power consumption is measured in dim-to-off as follows:

**Table 9 Standby power**

Input	Output open
90 V AC	216 mW
110 V AC	238 mW
230 V AC	395 mW
277 V AC	496 mW

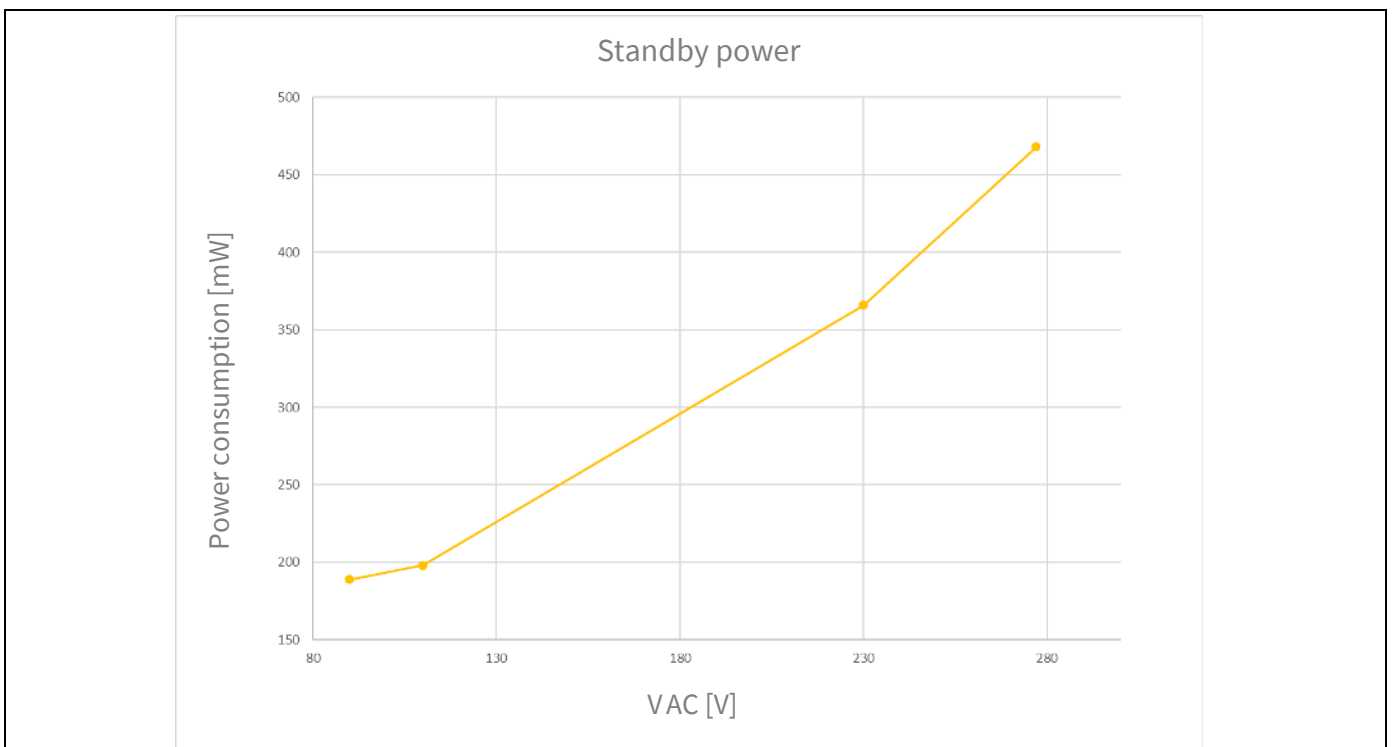

**Figure 15 320 W HP LED driver standby power in dim-to-off**

## 7 ICL5102 320 W reference board standalone measurement results

### 7.1 Performance

**Table 10 Measurement with 90 V AC input**

$V_{IN}$ (V AC)	$P_{IN}$ (W)	$V_{OUT}$ (V)	Output voltage ripple pk-pk (V)	$I_{OUT}$ (A)	PF	THD (%)	$\eta$ (%)
90	349.1	73.5	1.22	4.33 (100 percent)	0.99	3.1	91.22
90	260.3	73.5	0.76	3.25 (75 percent)	0.99	3.2	91.88
90	172.8	73.6	0.51	2.16 (50 percent)	0.99	3.2	91.98
90	88.2	73.6	0.36	1.07 (25 percent)	0.99	2.9	89.31
90	38.7	73.6	0.35	0.42 (10 percent)	0.97	5.3	79.91
90	22.5	73.6	0.35	0.20 (5 percent)	0.91	14.5	65.41
90	13.5	73.5	2.60 (burst mode)	0.04 (1 percent)	–	–	–

**Table 11 Measurement with 110 V AC input**

$V_{IN}$ (V AC)	$P_{IN}$ (W)	$V_{OUT}$ (V)	Output voltage ripple pk-pk (V)	$I_{OUT}$ (A)	PF	THD (%)	$\eta$ (%)
110	342.7	73.5	1.35	4.33 (100 percent)	0.99	3.6	92.71
110	256.6	73.5	0.60	3.25 (75 percent)	0.99	3.2	92.90
110	171.7	73.6	0.46	2.16 (50 percent)	0.99	3.1	92.18
110	88.0	73.6	0.37	1.07 (25 percent)	0.99	3.4	88.73
110	39.5	73.6	0.36	0.42 (10 percent)	0.94	7.8	76.31
110	24.2	73.6	0.33	0.20 (5 percent)	0.83	20.4	60.84
110	16.5	73.5	2.58 (burst mode)	0.04 (1 percent)	–	–	–

# 320 W multichannel high-power LED driver (using ICL5102 + ILD8150) engineering report



## ICL5102 320 W reference board standalone measurement results

**Table 12 Measurement with 230 V AC input**

$V_{IN}$ (V AC)	$P_{IN}$ (W)	$V_{OUT}$ (V)	Output voltage ripple pk-pk (V)	$I_{OUT}$ (A)	PF	THD (%)	$\eta$ (%)
230	338.1	73.5	1.28	4.33 (100 percent)	0.98	3.6	93.97
230	257.7	73.5	0.79	3.25 (75 percent)	0.97	5.0	92.52
230	177.1	73.6	0.53	2.16 (50 percent)	0.94	7.1	89.34
230	101.1	73.6	0.41	1.07 (25 percent)	0.82	10.4	76.44
230	64.4	73.6	0.31	0.42 (10 percent)	0.53	18.2	45.74
230	48.3	73.6	0.30	0.20 (5 percent)	0.37	23.6	28.96
230	41.3	73.5	2.64 (burst mode)	0.04 (1 percent)	–	–	–

**Table 13 Measurement with 277 V AC input**

$V_{IN}$ (V AC)	$P_{IN}$ (W)	$V_{OUT}$ (V)	Output voltage ripple pk-pk (V)	$I_{OUT}$ (A)	PF	THD (%)	$\eta$ (%)
277	346.2	73.5	1.23	4.33 (100 percent)	0.97	5.4	91.99
277	265.9	73.5	0.56	3.25 (75 percent)	0.95	7.2	89.66
277	185.6	73.6	0.48	2.16 (50 percent)	0.9	9.0	84.86
277	116.3	73.6	0.33	1.07 (25 percent)	0.71	13.1	65.83
277	77.5	73.6	0.30	0.42 (10 percent)	0.43	22.3	37.05
277	63.7	73.6	0.28	0.20 (5 percent)	0.29	23.7	21.97
277	58.1	73.5	2.64 (burst mode)	0.04 (1 percent)	–	–	–

ICL5102 320 W reference board standalone measurement results



Figure 16 ICL5102 320 W reference board power efficiency measurement

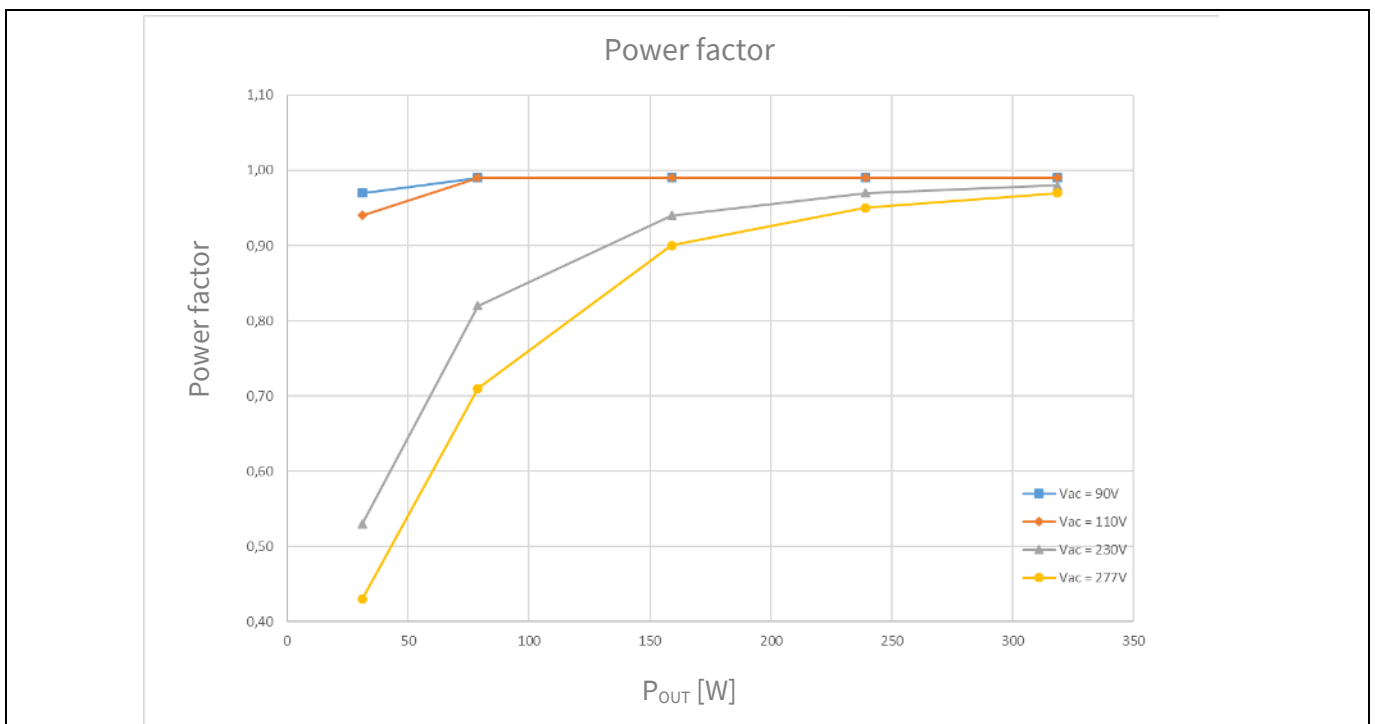

Figure 17 ICL5102 320 W reference board PF measurement



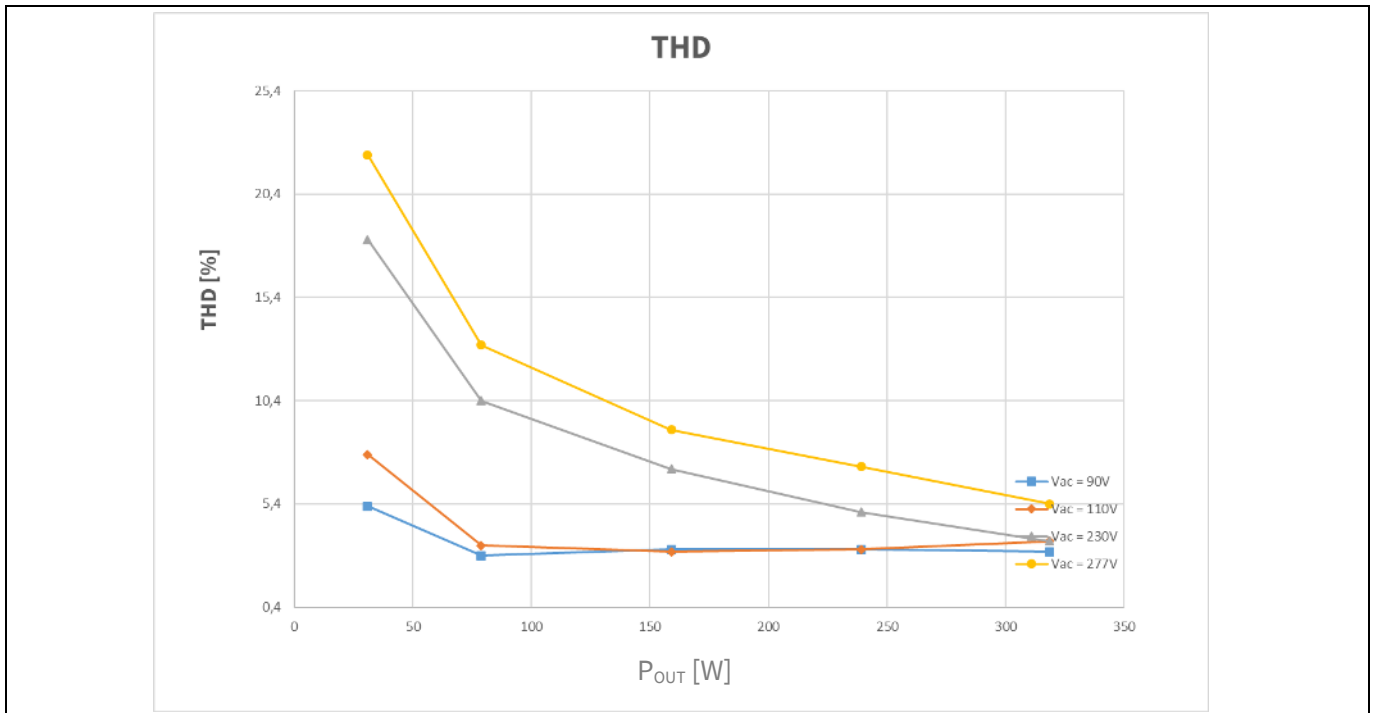

Figure 18 ICL5102 320 W reference board THD measurement

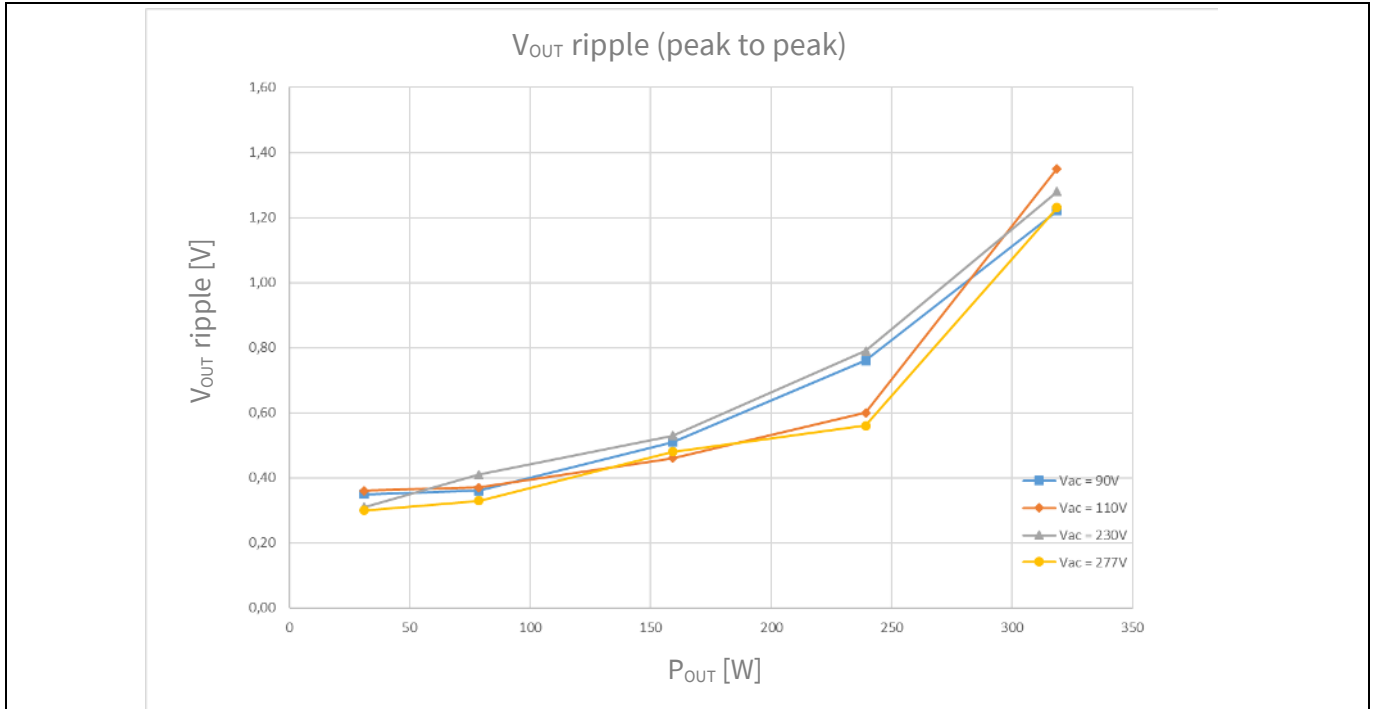

Figure 19 ICL5102 320 W reference board output voltage ripple measurement

## 7.2 Line current harmonics measurement

The line current harmonics is measured as follows:

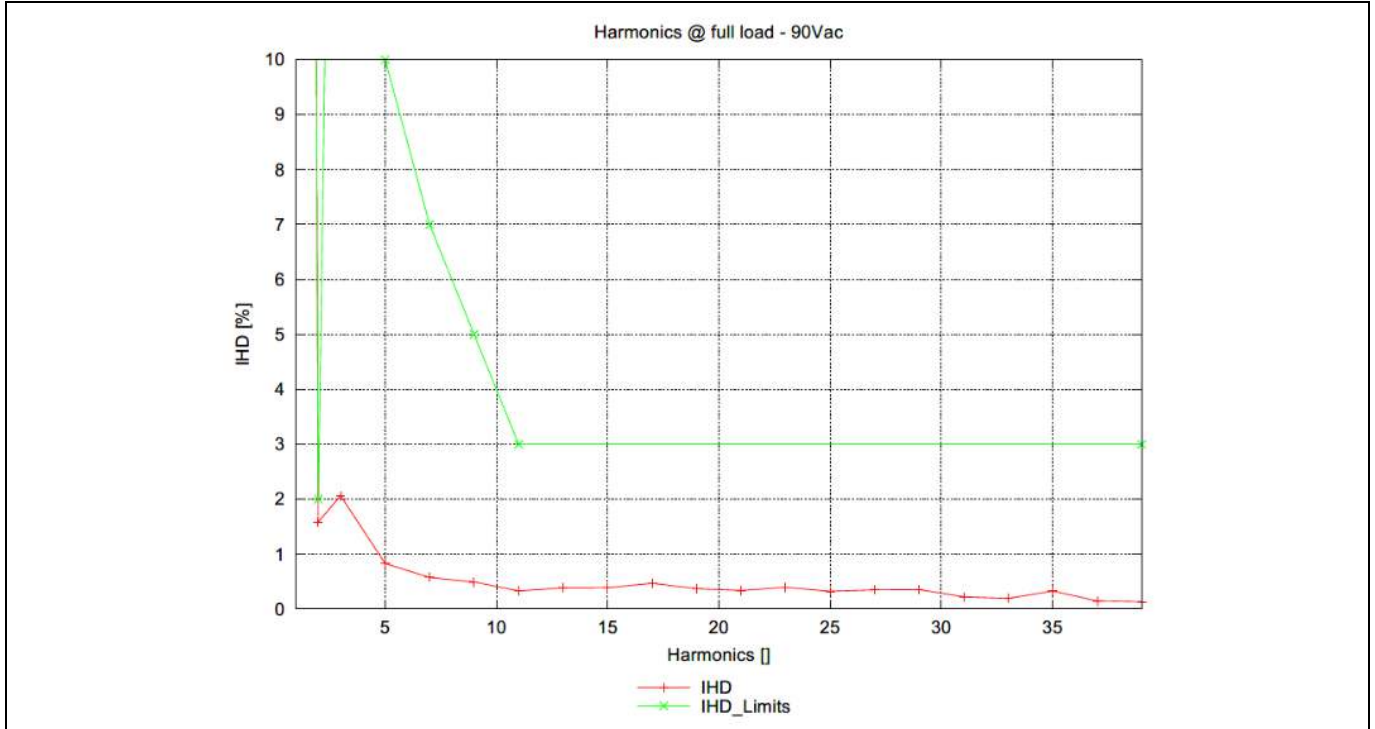

Figure 20 Line current harmonics V AC = 90 V/50 Hz, 100 percent load

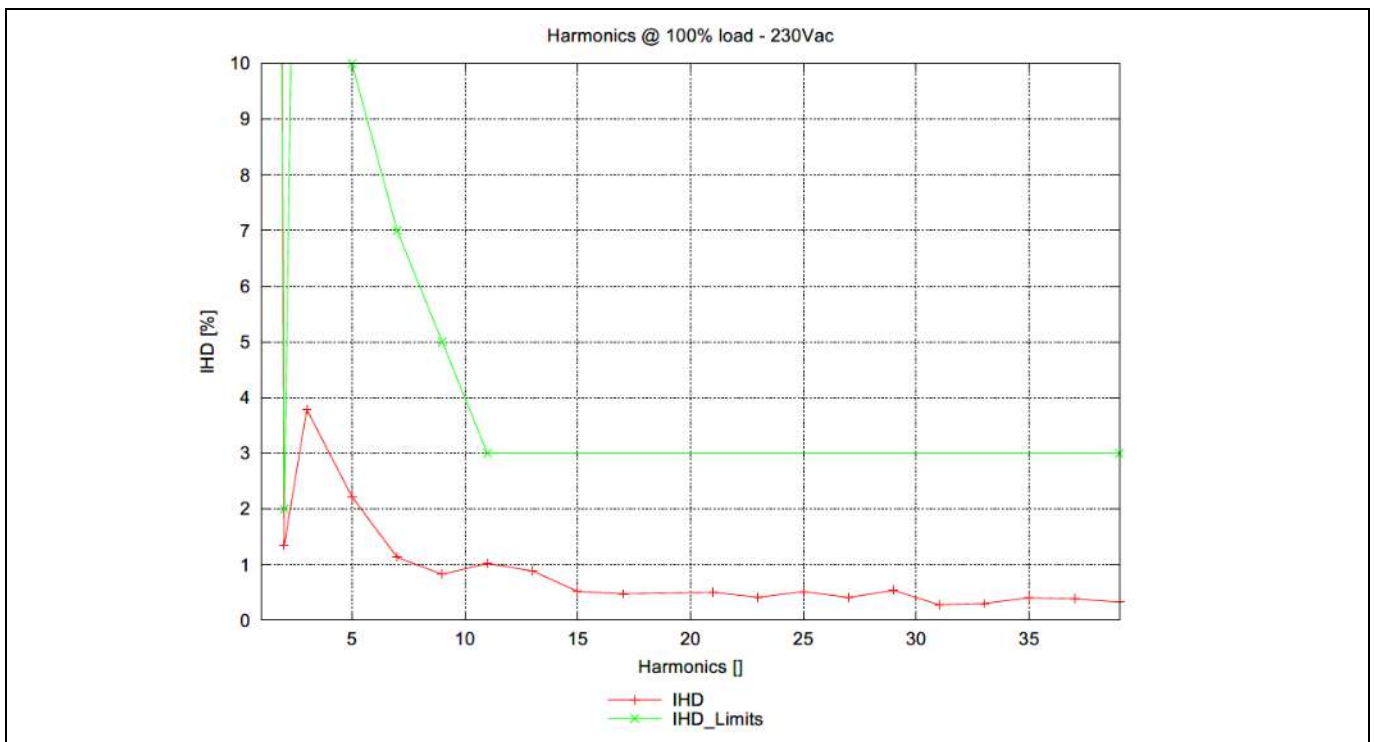

Figure 21 Line current harmonics V AC = 230 V/50 Hz, 100 percent load

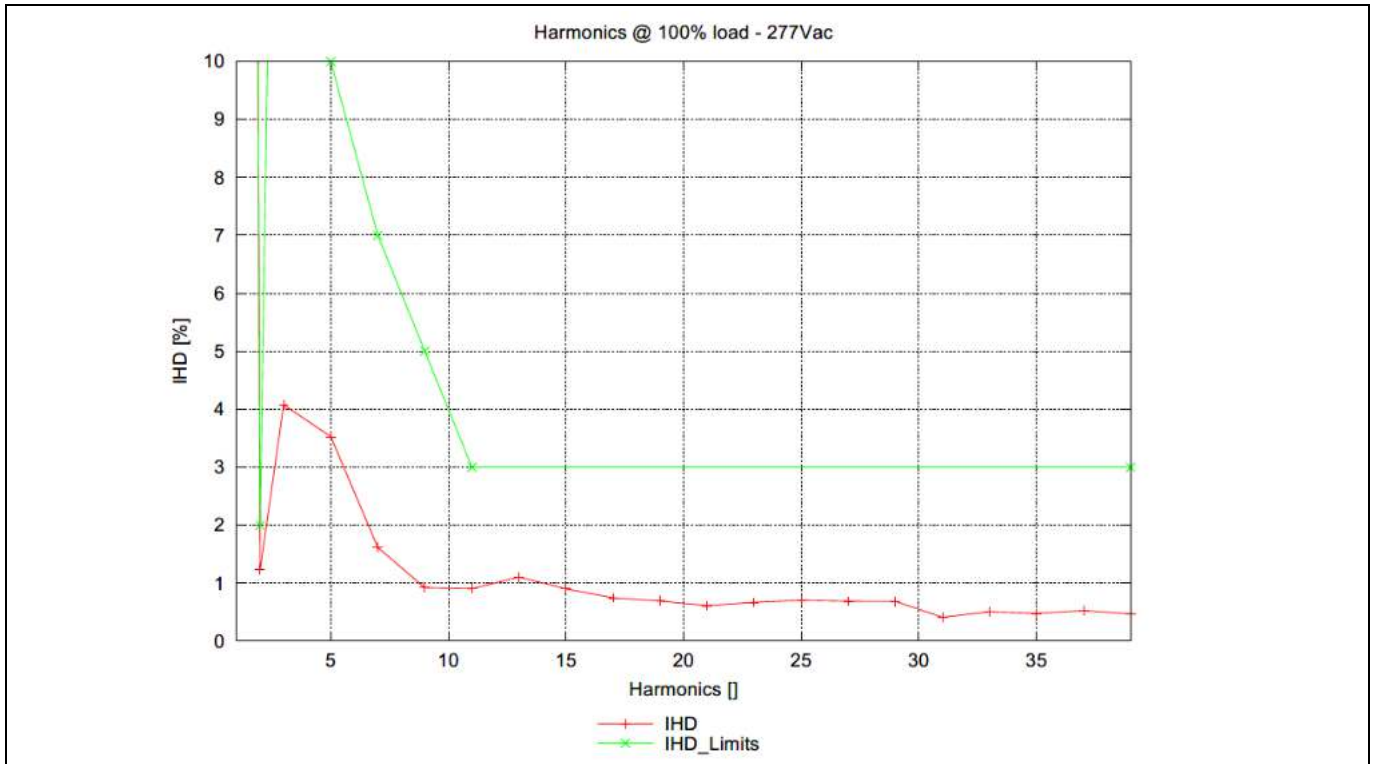

Figure 22 Line current harmonics V AC = 277 V/50 Hz, 100 percent load

### 7.3 Start-up delay

The start-up delay is measured as follows:

Table 14 Start-up delay

Input	Start-up time
90 V AC	0.43 s
110 V AC	0.21 s
230 V AC	0.11 s
277 V AC	0.09 s

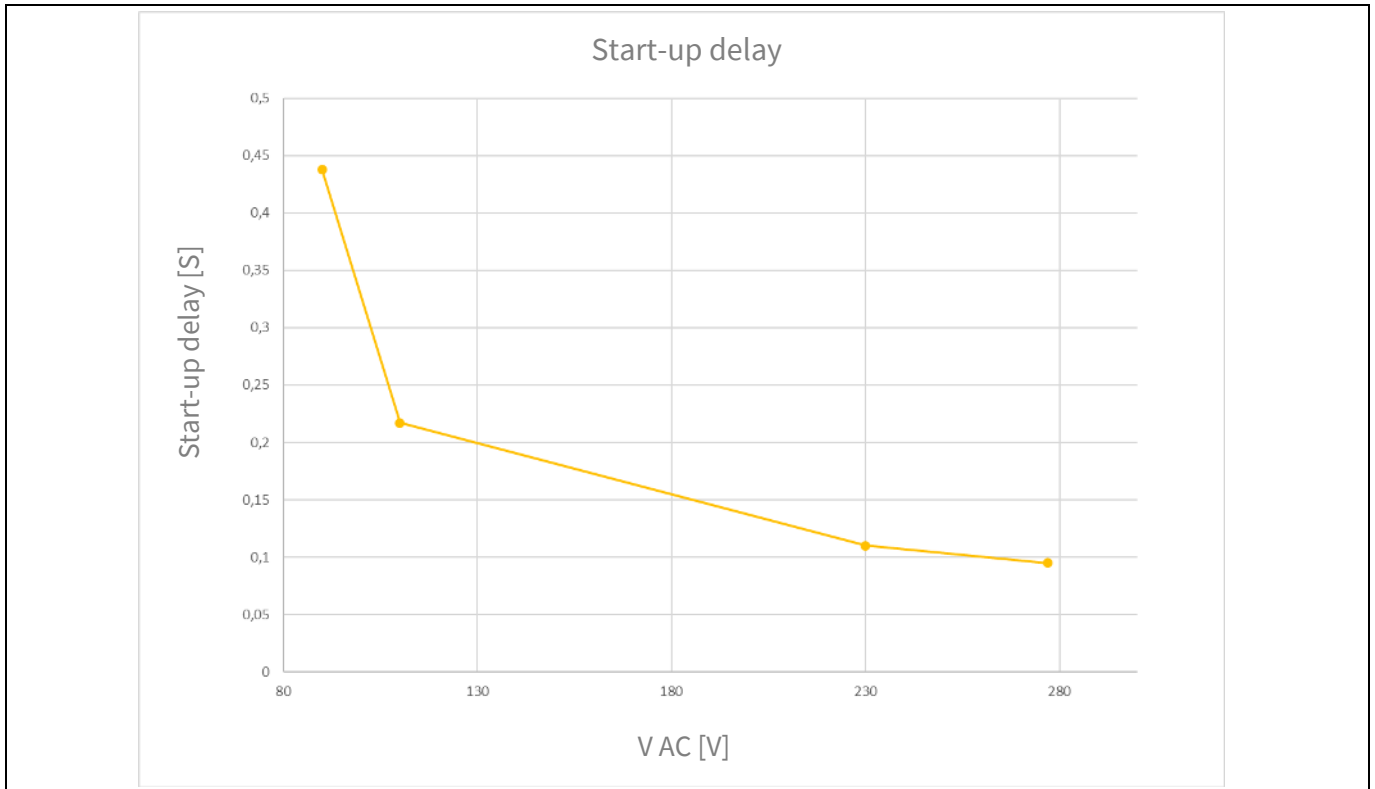

**Figure 23 ICL5102 320 W reference board start-up delay at full load**

## 7.4 Standby power consumption

The standby power consumption is measured as follows:

**Table 15 Standby power**

<b>Input</b>	<b>Output open</b>
90 V AC	189 mW
110 V AC	198 mW
230 V AC	366 mW
277 V AC	468 mW

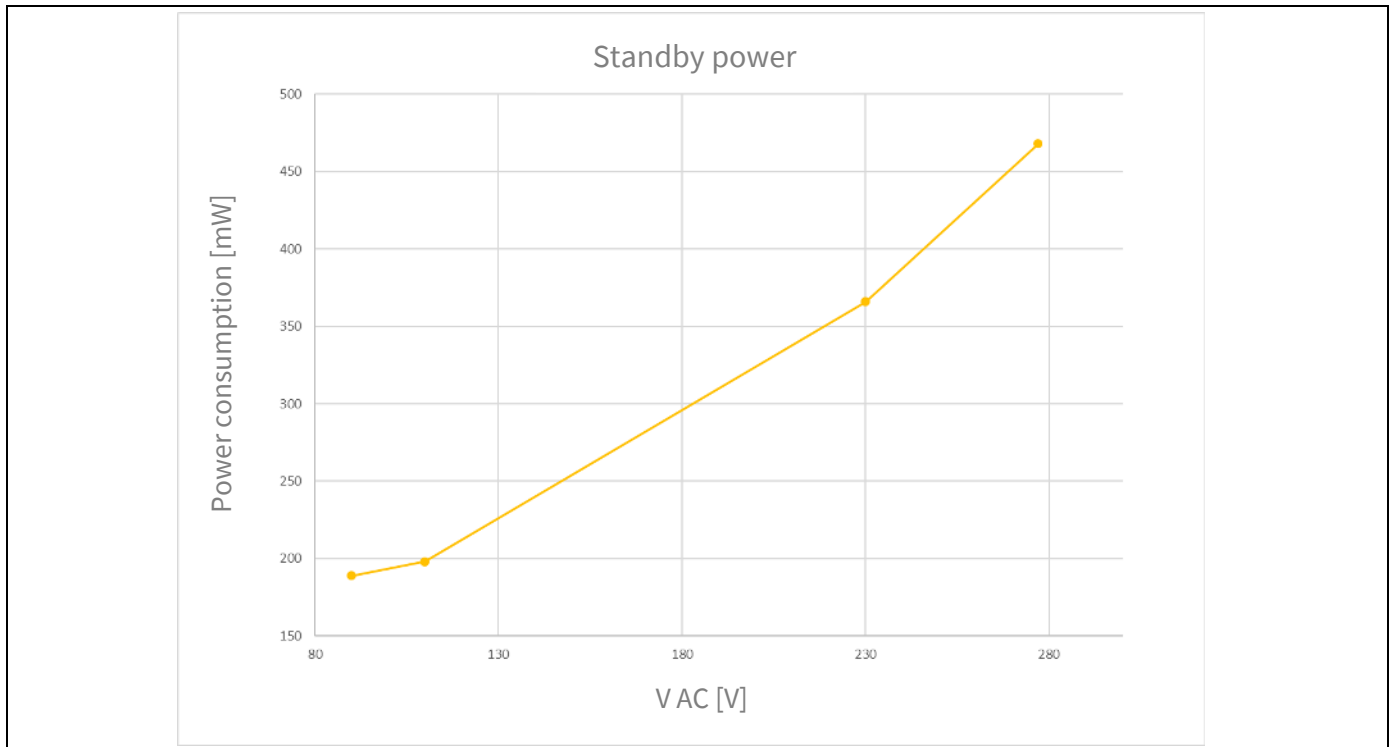

Figure 24 ICL5102 320 W reference board standby power

## 7.5 EMI performance

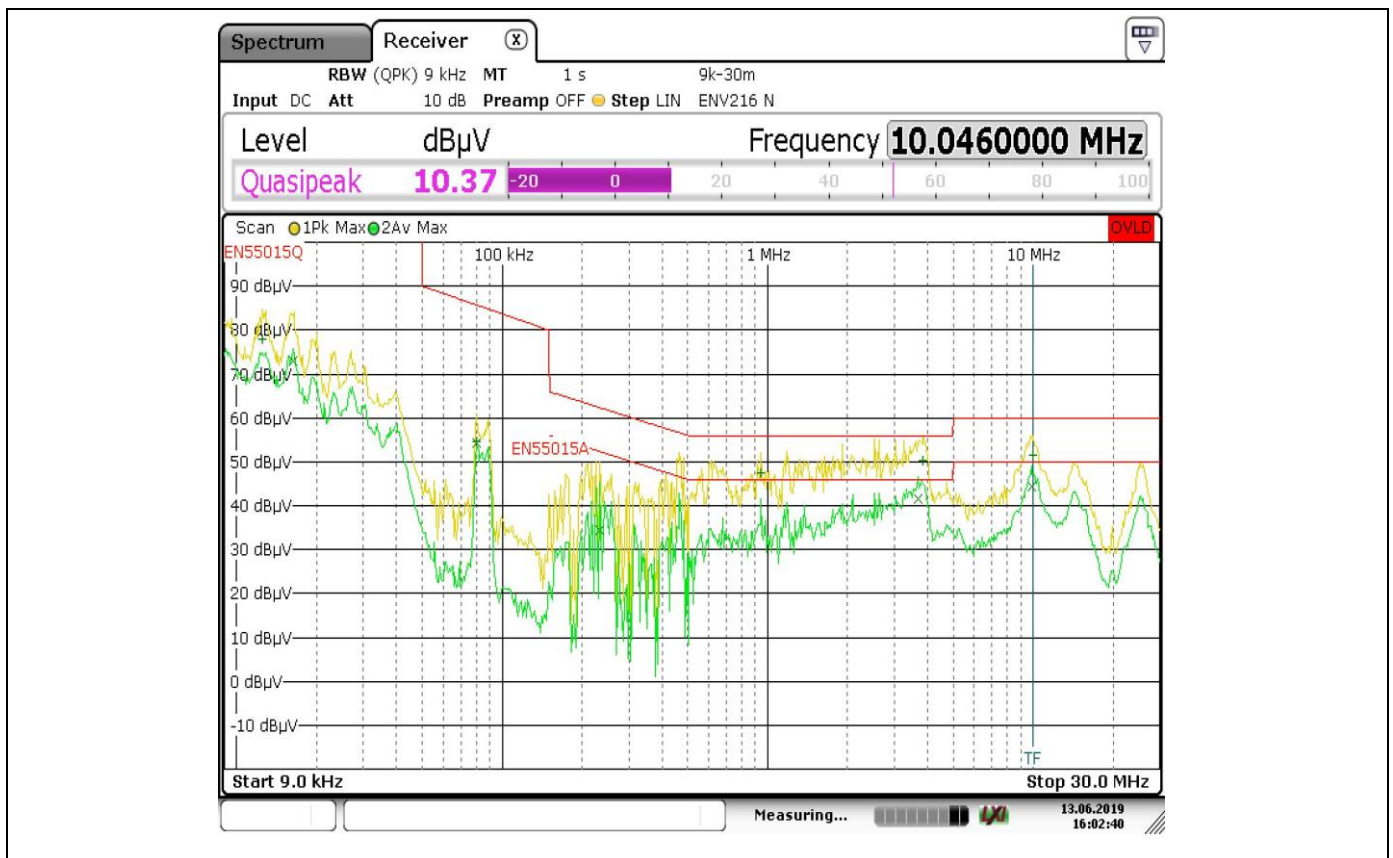

Figure 25 EMI measurement at 230 V AC with full load



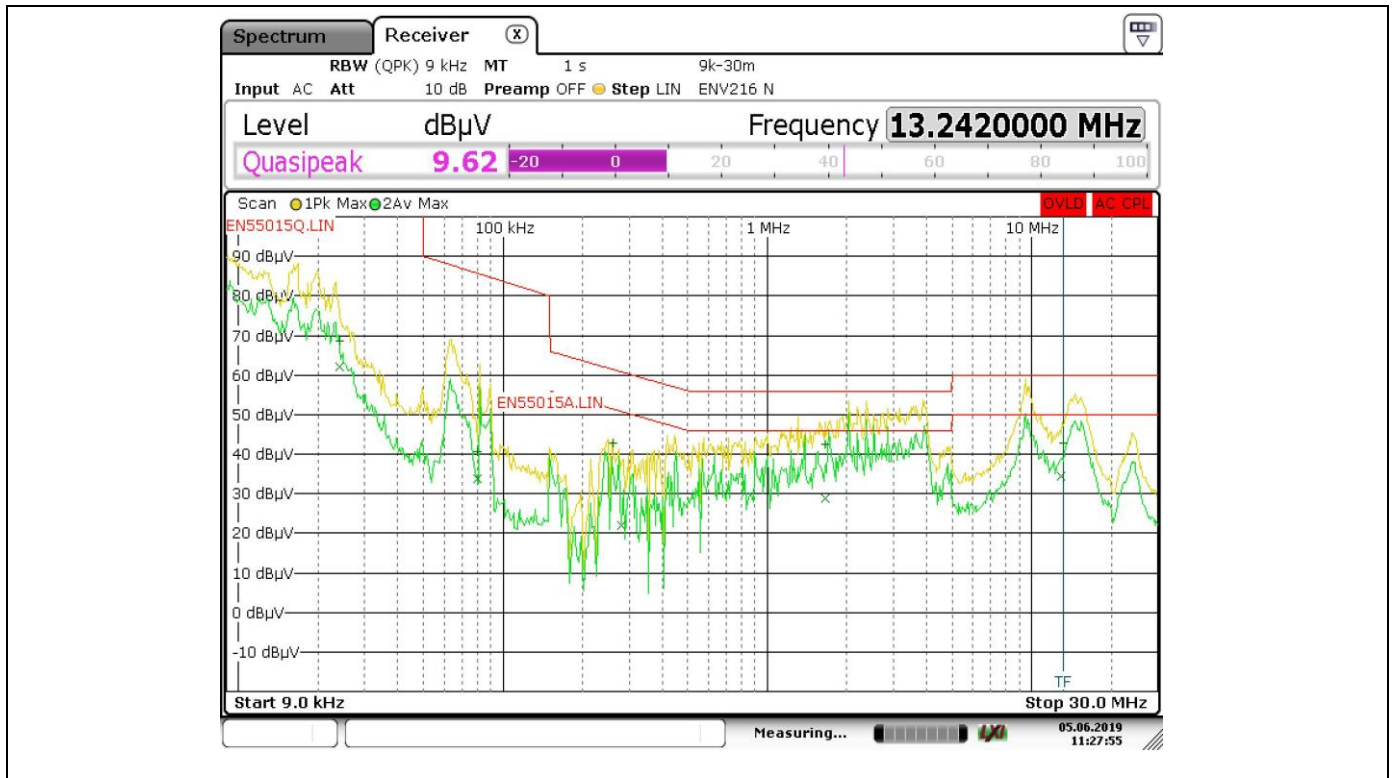

Figure 26 EMI measurement at 110 V AC with full load

### 7.6 Thermal measurement

The thermal pictures below were taken after the reference board had been operated for 1.5 hours at V AC = 90 V with full load 320 W.

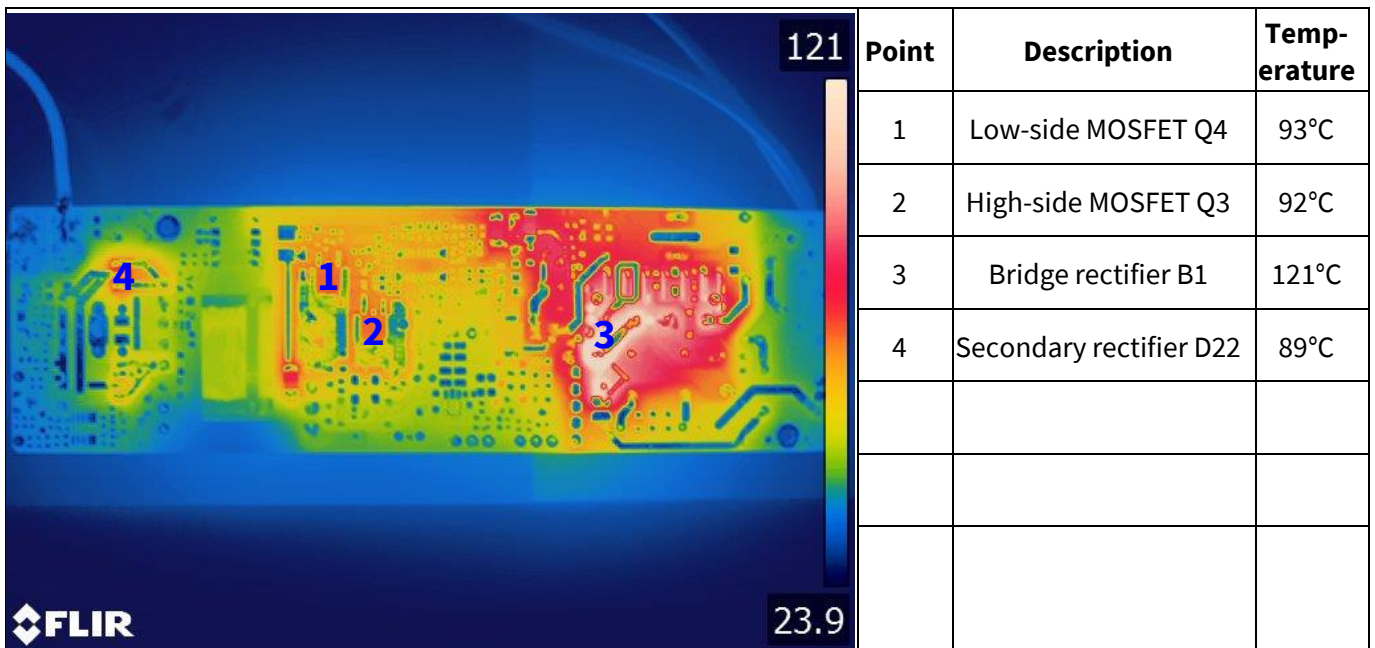

Figure 27 Thermal measurement – bottom side at 90 V AC with full load

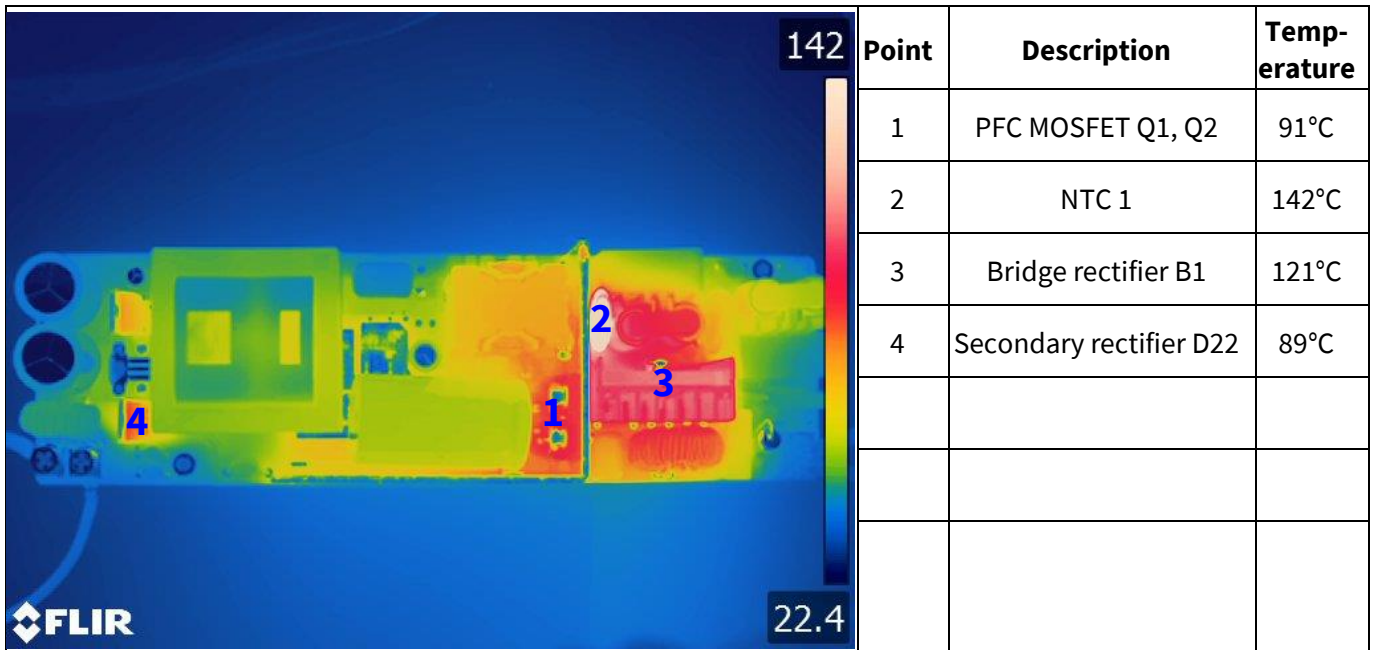

Figure 28 Thermal measurement – top side at 90 V AC with full load

BOM

## 8 BOM

Table 16 ICL5102 320 W reference board BOM

Quantity	Designator	Value	Description	Manufacturer	Part number
1		PCB, FR4, 1 oz., L254 mm x W58 mm x t1.6 mm, RoHS	PCB		320 W PCB V0.99B
4	C15, C19, C20, C43	100 nF/50 V/X7R 15 percent	Capacitor		
2	C12, C26	100 pF/50 V/COG 15 percent	Capacitor		
1	C37	33 nF/50 V/X7R 15 percent	Capacitor		
2	C17, C22	100 nF/50 V/X7R 15 percent	Capacitor		
5	C13, C14, C24, C41, C44	1 $\mu$ F/50 V/X7R 15 percent	Capacitor		
3	C11, C18, C25	2.2 nF/50 V/COG 5 percent	Capacitor		
1	C23	22 nF/50 V/7 R/15 percent	Capacitor		
2	C5, C29	100 pF/1 kV/COG 5 percent	Capacitor		
2	C6, C10	10 nF/1 kV/X7R/10 percent	Capacitor	TDK	C3216X7R3A103KT0 20U
2	C1, C2	1.0 $\mu$ F/X2/305 V AC/W27 mm x T11 mm x H25 mm max.	Capacitor	Würth	890334026027
1	C30	B32672L6473	Capacitor	TDK	B32672L6473
1	C4	MPP 1.5 $\mu$ F/450 V/W18 mm x T7 mm x H25 mm max.	Capacitor	TDK	B32672P4155K
1	C3	1 $\mu$ F+/-10 percent/450 V W12.5 mm x T9.5 mm x H20 mm max.	Capacitor	Faratronic	C222S105M4S****
2	L1, L2	SQ1918 vertical 8 mH 8 A	Common choke		
1	L5	Common choke, 10 A , 785 $\mu$ H	Common choke		
1	D14	Zener diode, 7.5, V 5 percent	Zener diode		BZT55C7V5
2	D11, D13	Zener diode, 18 V, 5 percent	Zener diode		BZT55C18
3	D7, D8, D21	Diode, US1D	Diode		US1D
1	D4	Diode, S1M	Diode		S1M
1	D16	Diode, US1M	Diode		US1M
1	D1	Diode, S5M	Diode	Taiwan Semi	S5M

# 320 W multichannel high-power LED driver (using ICL5102 + ILD8150) engineering report



## BOM

Quantity	Designator	Value	Description	Manufacturer	Part number
3	D5, D6, D10	Diode, 1N4148W	Diode	Taiwan Semi	1N4148W
2	D22, D23	Diode, V30202C	Diode	Vishay	V30202C
1	D2	Diode, MURF1560G	Diode	OnSemi	MURF1560G
1	F1	500 V AC, 6.3 A slow blow	Fuse	Belfuse	5HTP 6.3-R
1	K1	Heatsink, L55 + 70 x T2	Heatsink		
1	K3	YED30, W33 mm x T15 mm x H30 mm	Heatsink		Refer to drawing
1	For F1	Heat-shrinkable tube, dia. 7 mm, UL approved	Heat-shrinkable tube		
1	For NTC1	Heat-shrinkable tube, dia. 12 mm, UL approved	Heat-shrinkable tube		
1	U2	Shunt regulator: CJ431	IC	ST	TL432AIL3T
1	U1	Controller: ICL5102G	IC, PFC+HB resonant controller	Infineon	ICL5102G
1	L6	L0 mm x dia. 1 mm jumper	Inductor		
2	Q3, Q4	MOSFET 600 V, $R_{DS(on)} = 0.18 \Omega$ , DPAK	MOSFET	Infineon	IPD60R180P7S
1	Q1	MOSFET 600 V, $R_{DS(on)} = 0.6 \Omega$ , TO-220 FullPAK	MOSFET	Infineon	IPA60R060P7
3	For B1, Q1, D2 assembly	Screw M3 x 8, with spring pad and flat pad, flat pad dia. = 6 mm	screw		
0.1g	For Q1 and B1 assembly	Thermal grease	HT-WT160		
1	MOV2	MOV 560 V, dia. 14 mm	MOV	Thinking	TVR14561-D
1	MOV1	MOV 560 V, dia. 20 mm	MOV	Thinking	TVR20561-D
1	T3	NPN transistor, MMBT3904	Transistor, NPN		MMBT3904
3	T1, T7, T8	SS8550	Transistor, PNP		SS8550
1	NTC1	NTC SCK13055, 5 $\Omega$ /5 A	NTC	Thinking	SCK13055
1	U5	EL817S(C)	Optocoupler	Liteon	EL817SC
1	L4	PQ2625 Würth 750344179-01	PFC choke	Würth	750344179-01

# 320 W multichannel high-power LED driver (using ICL5102 + ILD8150) engineering report



## BOM

Quantity	Designator	Value	Description	Manufacturer	Part number
1	C8	120 $\mu$ F/450 V +/-20 percent	Electronized capacitor	Aishi	EGZ2HM1210400T
1	C21	100 $\mu$ F/50 V +/-20 percent	Electronized capacitor	Aishi	ERN1HM101F090T
1	C33	47 $\mu$ F/50 V +/-20 percent	Electronized capacitor	Aishi	ERS1HM470E090T
2	C40, C42	390 $\mu$ F/100 V +/-20 percent	Electronized capacitor	Aishi	ERN1KM391L250T
1	B1	Full-bridge 8 A/1 kV	Rectifier	Taiwan Semi	TS8P07G
1	R45	0 R	Resistor		
4	R22, R42, R56, R59	1.0 kR +/-1 percent	Resistor		
1	R40	100 kR +/-1 percent	Resistor		
2	R50, R53	100 RR +/-1 percent	Resistor		
1	R41	105 kR +/-1 percent	Resistor		
1	R12	10 kR +/-1 percent	Resistor		
1	R34	165 kR +/-1 percent	Resistor		
1	R38	19.6 kR +/-1 percent	Resistor		
2	R1, R11	2 kR +/-1 percent	Resistor		
1	R28	20 kR +/-1 percent	Resistor		
1	R37	27 kR +/-1 percent	Resistor		
1	R39	3.9 kR +/-1 percent	Resistor		
1	R43	330 kR +/-1 percent	Resistor		
1	R61	3 kR +/-1 percent	Resistor		
1	R33	47.5 kR +/-1 percent	Resistor		
6	R15, R29, R36, R52, R55, R69	47 kR +/-1 percent	Resistor		
1	R71	9.53 kR +/-1 percent	Resistor		
1	NTC	NTC resistor, TDK: NTCG164LH104JT1	Resistor	TDK	NTCG164LH104JT1
1	R21	33 kR +/-1 percent	Resistor		
5	R16, R27, R48, R51, R54	5.1 R +/-1 percent	Resistor		
1	R23	510 R +/-1 percent	Resistor		
8	R8, R8A, R8B, R8C, R9, R9A, R9B, R9C	2 MR +/-1 percent	Resistor		
1	R24	0.1 R +/-1 percent	Resistor		

# 320 W multichannel high-power LED driver (using ICL5102 + ILD8150) engineering report



## BOM

Quantity	Designator	Value	Description	Manufacturer	Part number
3	JP1, JP2, R64	0 R	Resistor		
6	R7, R7A, R7B, R7C, R7E, R7F	20 kR +/-1 percent	Resistor		
1	R76	270 kR +/-1 percent	Resistor		
3	R2, R3, R4	330 kR +/-1 percent	Resistor		
1	RA	39 kR +/-1 percent	Resistor		
1	R58	0.20 R/2512 +/-1 percent	Resistor		
1	R77	0 mΩ/2512, 5 mΩ max.	Resistor		
2	R10, R14	80 mR/2512/2 W +/-1 percent	Resistor		
1	L3	Inductor 100 μH, 5 A	Inductor	Würth	7447070
1	X1	Connector	Connector	Würth	691412120003B
1	TR1	Transformer -ETD44	Transformer	Würth	750344267-02
6	CY1, CY2, CY3, CY4, CY6, CY7	1000 pF/300 V AC/Y2 +/-15 percent	Y-capacitor	TDK	CS45-E2GA102M-NKA
1	CY5	Y1 -400 V AC/-2.2 nF +/-15 percent	Y1-capacitor	TDK	CD45-E2GA222M-NKA
1	Q2	BSS126	Depletion MOSFET	Infineon	BSS126
4	O/P-1, O/P-2, O/P-3, O/P-4	Connector, 5.08 mm, 20 A, 4-pin	Connector	Würth	691311500104
1	Fix C8 on PCB	130°C, W10 mm, T2 mm, L20 mm, double-side glued	High-temperature foam	3M	120°C or above

## 9 Transformers specification

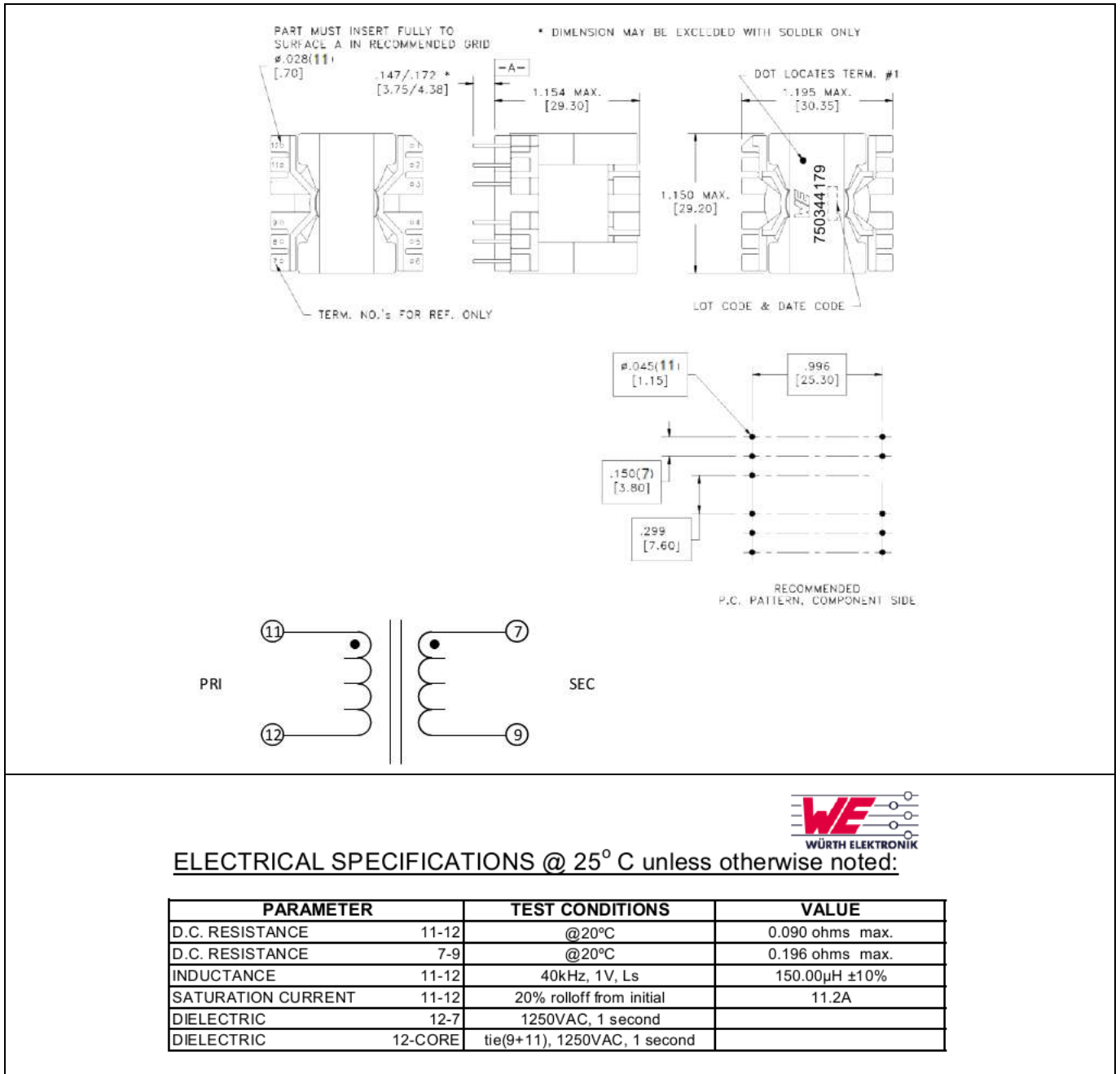

Figure 29 Würth Elektronik PFC choke 750344179 rev01 specification



# 320 W multichannel high-power LED driver (using ICL5102 + ILD8150) engineering report



## Transformers specification

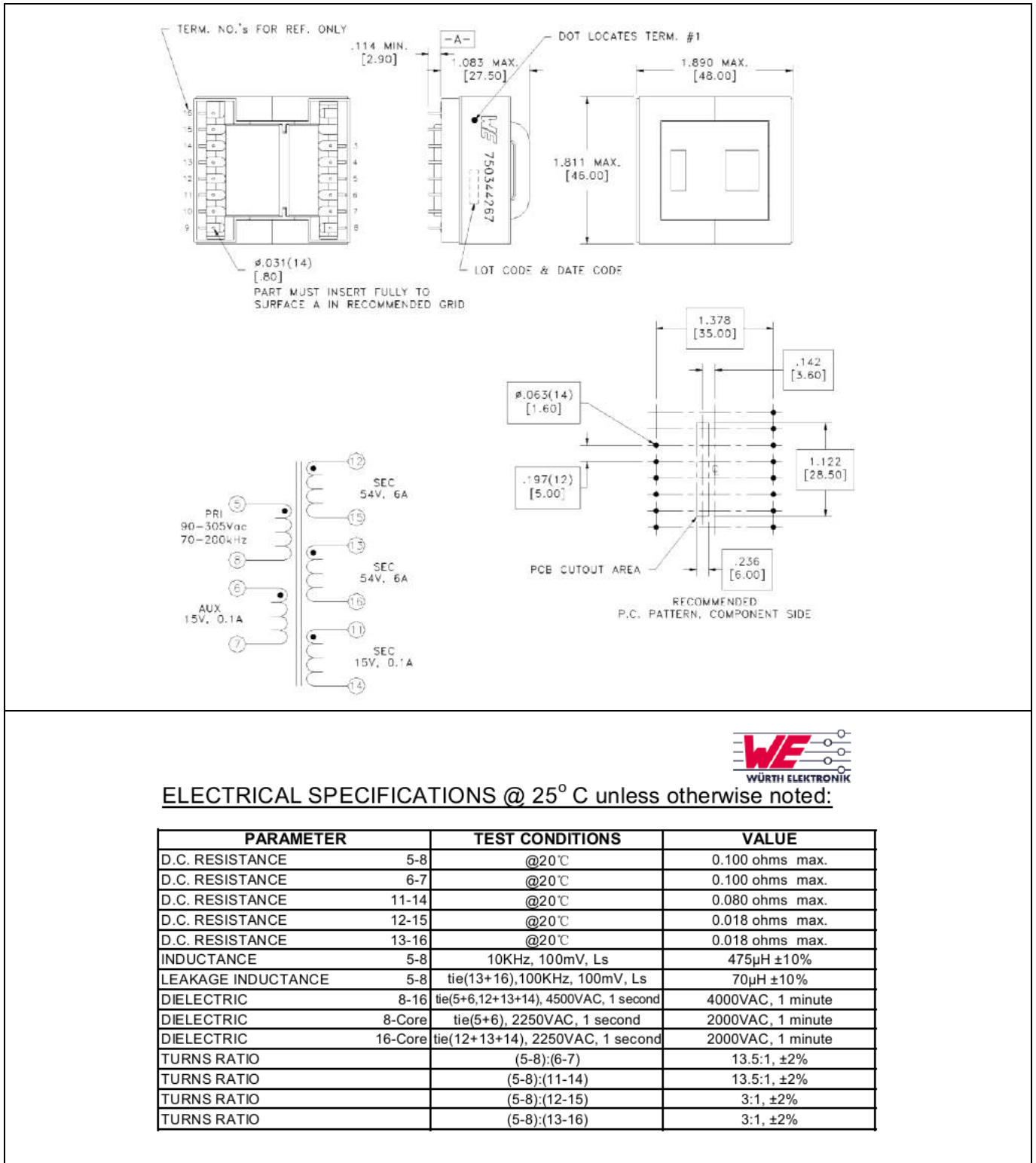

Figure 30 Würth Elektronik Flyback transformer 750344267 rev02 specification



## Revision history

<b>Document version</b>	<b>Date of release</b>	<b>Description of changes</b>
V 1.0	19-06-2020	First release

**Trademarks**

All referenced product or service names and trademarks are the property of their respective owners.

**Edition 2020-06-19**

**Published by**

**Infineon Technologies AG**

**81726 Munich, Germany**

**© 2020 Infineon Technologies AG.**

**All Rights Reserved.**

**Do you have a question about this document?**

**Email: [erratum@infineon.com](mailto:erratum@infineon.com)**

**Document reference**

**ER\_2005\_PL39\_2006\_105832**

**IMPORTANT NOTICE**

The information contained in this application note is given as a hint for the implementation of the product only and shall in no event be regarded as a description or warranty of a certain functionality, condition or quality of the product. Before implementation of the product, the recipient of this application note must verify any function and other technical information given herein in the real application. Infineon Technologies hereby disclaims any and all warranties and liabilities of any kind (including without limitation warranties of non-infringement of intellectual property rights of any third party) with respect to any and all information given in this application note.

The data contained in this document is exclusively intended for technically trained staff. It is the responsibility of customer's technical departments to evaluate the suitability of the product for the intended application and the completeness of the product information given in this document with respect to such application.

For further information on the product, technology, delivery terms and conditions and prices please contact your nearest Infineon Technologies office ([www.infineon.com](http://www.infineon.com)).

**WARNINGS**

Due to technical requirements products may contain dangerous substances. For information on the types in question please contact your nearest Infineon Technologies office.

Except as otherwise explicitly approved by Infineon Technologies in a written document signed by authorized representatives of Infineon Technologies, Infineon Technologies' products may not be used in any applications where a failure of the product or any consequences of the use thereof can reasonably be expected to result in personal injury.