



### GENERAL DESCRIPTION



The ICS8532AY-01 is a low skew, 1-to-17, Differential-to-3.3V LVPECL Fanout Buffer and a member of the HiPerClockS™ family of High Performance Clock Solutions from ICS. The ICS8532AY-01 has two selectable clock inputs.

The CLK, nCLK pair can accept most standard differential input levels. The PCLK, nPCLK pair can accept LVPECL, CML, or SSTL input levels. The clock enable is internally synchronized to eliminate runt pulses on the outputs during asynchronous assertion/deassertion of the clock enable pin.

Guaranteed output and part-to-part skew characteristics make the ICS8532AY-01 ideal for those clock distribution applications demanding well defined performance and repeatability.

### FEATURES

- Seventeen differential 3.3V LVPECL outputs
- Selectable differential CLK, nCLK or LVPECL clock inputs
- CLK, nCLK pair can accept the following differential input levels: LVPECL, LVDS, LVHSTL, SSTL, HCSL
- PCLK, nPCLK supports the following input types: LVPECL, CML, SSTL
- Maximum output frequency: 500MHz
- Translates any single-ended input signal (LVCMOS, LVTTTL, GTL) to 3.3V LVPECL levels with resistor bias on nCLK input
- Output skew: 50ps (maximum)
- Part-to-part skew: 250ps (maximum)
- Propagation delay: 2.5ns (maximum)
- 3.3V operating supply
- 0°C to 70°C ambient operating temperature
- Industrial temperature information available upon request

### BLOCK DIAGRAM

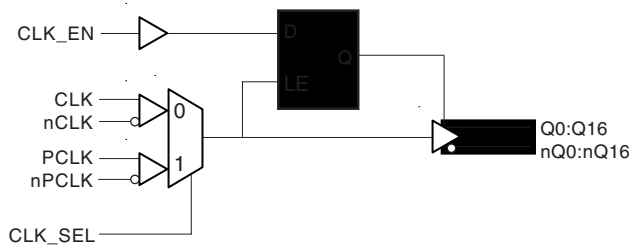

### PIN ASSIGNMENT

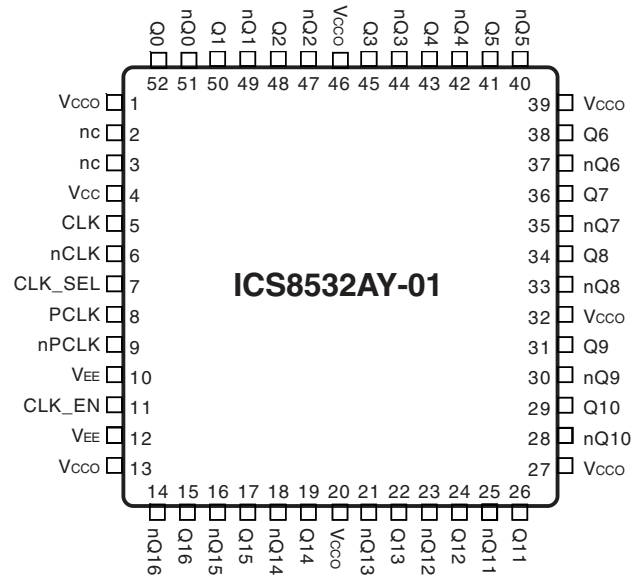

**52-Lead LQFP**  
10mm x 10mm x 1.4mm body package  
**Y package**  
Top View



**TABLE 1. PIN DESCRIPTIONS**

Number	Name	Type		Description
1, 13, 20, 27, 32, 39, 46	V <sub>CCO</sub>	Power		Output supply pins.
2, 3	nc	Unused		No connect.
4	V <sub>CC</sub>	Power		Core supply pin.
5	CLK	Input	Pulldown	Non-inverting differential clock input.
6	nCLK	Input	Pullup	Inverting differential clock input.
7	CLK_SEL	Input	Pulldown	Clock select input. When HIGH, selects PCLK, nPCLK inputs. When LOW, selects CLK, nCLK inputs. LVCMOS / LVTTTL interface levels.
8	PCLK	Input	Pulldown	Non-inverting differential LVPECL clock input.
9	nPCLK	Input	Pullup	Inverting differential LVPECL clock input.
10, 12	V <sub>EE</sub>	Power		Power supply ground.
11	CLK_EN	Input	Pullup	Synchronizing clock enable. When HIGH, clock outputs follows clock input. When LOW, Q outputs are forced low, nQ outputs are forced high. LVCMOS / LVTTTL interface levels.
14, 15	nQ16, Q16	Output		Differential clock outputs. LVPECL interface levels.
16, 17	nQ15, Q15	Output		Differential clock outputs. LVPECL interface levels.
18, 19	nQ14, Q14	Output		Differential clock outputs. LVPECL interface levels.
21, 22	nQ13, Q13	Output		Differential clock outputs. LVPECL interface levels.
23, 24	nQ12, Q12	Output		Differential clock outputs. LVPECL interface levels.
25, 26	nQ11, Q11	Output		Differential clock outputs. LVPECL interface levels.
28, 29	nQ10, Q10	Output		Differential clock outputs. LVPECL interface levels.
30, 31	nQ9, Q9	Output		Differential clock outputs. LVPECL interface levels.
33, 34	nQ8, Q8	Output		Differential clock outputs. LVPECL interface levels.
35, 36	nQ7, Q7	Output		Differential clock outputs. LVPECL interface levels.
37, 38	nQ6, Q6	Output		Differential clock outputs. LVPECL interface levels.
40, 41	nQ5, Q5	Output		Differential clock outputs. LVPECL interface levels.
42, 43	nQ4, Q4	Output		Differential clock outputs. LVPECL interface levels.
44, 45	nQ3, Q3	Output		Differential clock outputs. LVPECL interface levels.
47, 48	nQ2, Q2	Output		Differential clock outputs. LVPECL interface levels.
49, 50	nQ1, Q1	Output		Differential clock outputs. LVPECL interface levels.
51, 52	nQ0, Q0	Output		Differential clock outputs. LVPECL interface levels.

NOTE: *Pullup* and *Pulldown* refer to internal input resistors. See Table 2, Pin Characteristics, for typical values.

NOTE: Unused output pairs must be terminated.

**TABLE 2. PIN CHARACTERISTICS**

Symbol	Parameter	Test Conditions	Minimum	Typical	Maximum	Units
C <sub>IN</sub>	Input Capacitance			4		pF
R <sub>PULLUP</sub>	Input Pullup Resistor			51		kΩ
R <sub>PULLDOWN</sub>	Input Pulldown Resistor			51		kΩ

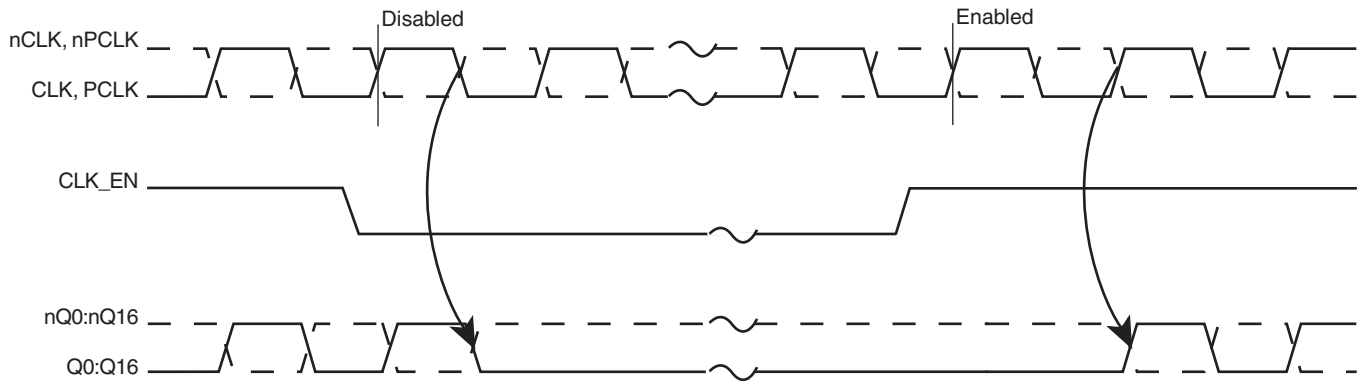

**TABLE 3A. CONTROL INPUT FUNCTION TABLE**

Inputs			Outputs	
CLK_EN	CLK_SEL	Selected Source	Q0:Q16	nQ0:nQ16
0	0	CLK, nCLK	Disabled; LOW	Disabled; HIGH
0	1	PCLK, nPCLK	Disabled; LOW	Disabled; HIGH
1	0	CLK, nCLK	Enabled	Enabled
1	1	PCLK, nPCLK	Enabled	Enabled

After CLK\_EN switches, the clock outputs are disabled or enabled following a rising and falling input clock edge as shown in Figure 1.

In the active mode, the state of the outputs are a function of the CLK, nCLK and PCLK, nPCLK inputs as described in Table 3B.



**FIGURE 1. CLK\_EN TIMING DIAGRAM**

**TABLE 3B. CLOCK INPUT FUNCTION TABLE**

Inputs		Outputs		Input to Output Mode	Polarity
CLK or PCLK	nCLK or nPCLK	Q0:Q16	nQ0:nQ16		
0	1	LOW	HIGH	Differential to Differential	Non Inverting
1	0	HIGH	LOW	Differential to Differential	Non Inverting
0	Biased; NOTE 1	LOW	HIGH	Single Ended to Differential	Non Inverting
1	Biased; NOTE 1	HIGH	LOW	Single Ended to Differential	Non Inverting
Biased; NOTE 1	0	HIGH	LOW	Single Ended to Differential	Inverting
Biased; NOTE 1	1	LOW	HIGH	Single Ended to Differential	Inverting

NOTE 1: Please refer to the Application Information section "Wiring the Differential Input to Accept Single Ended Levels".



**ABSOLUTE MAXIMUM RATINGS**

Supply Voltage, $V_{CC}$	4.6V
Inputs, $V_i$	-0.5V to $V_{CC} + 0.5V$
Outputs, $V_o$	-0.5V to $V_{CCO} + 0.5V$
Package Thermal Impedance, $\theta_{JA}$	42.3°C/W (0 lfm)
Storage Temperature, $T_{STG}$	-65°C to 150°C

NOTE: Stresses beyond those listed under Absolute Maximum Ratings may cause permanent damage to the device. These ratings are stress specifications only. Functional operation of product at these conditions or any conditions beyond those listed in the *DC Characteristics* or *AC Characteristics* is not implied. Exposure to absolute maximum rating conditions for extended periods may affect product reliability.

**TABLE 4A. POWER SUPPLY DC CHARACTERISTICS,  $V_{CC} = V_{CCO} = 3.3V \pm 5\%$ ,  $T_A = 0^\circ C$  TO  $70^\circ C$**

Symbol	Parameter	Test Conditions	Minimum	Typical	Maximum	Units
$V_{CC}$	Core Supply Voltage		3.135	3.3	3.465	V
$V_{CCO}$	Output Supply Voltage		3.135	3.3	3.465	V
$I_{EE}$	Power Supply Current			122	150	mA

**TABLE 4B. LVCMOS / LVTTTL DC CHARACTERISTICS,  $V_{CC} = V_{CCO} = 3.3V \pm 5\%$ ,  $T_A = 0^\circ C$  TO  $70^\circ C$**

Symbol	Parameter	Test Conditions	Minimum	Typical	Maximum	Units
$V_{IH}$	Input High Current	CLK_EN, CLK_SEL	2		$V_{CC} + 0.3$	V
$V_{IL}$	Input Low Current	CLK_EN, CLK_SEL	-0.3		0.8	V
$I_{IH}$	Input High Current	CLK_SEL	$V_{IN} = V_{CC} = 3.465V$		150	$\mu A$
		CLK_EN	$V_{IN} = V_{CC} = 3.465V$		5	$\mu A$
$I_{IL}$	Input Low Current	CLK_SEL	$V_{IN} = 0V, V_{CC} = 3.465V$	-5		$\mu A$
		CLK_EN	$V_{IN} = 0V, V_{CC} = 3.465V$	-150		$\mu A$

**TABLE 4C. DIFFERENTIAL DC CHARACTERISTICS,  $V_{CC} = V_{CCO} = 3.3V \pm 5\%$ ,  $T_A = 0^\circ C$  TO  $70^\circ C$**

Symbol	Parameter	Test Conditions	Minimum	Typical	Maximum	Units
$I_{IH}$	Input High Current	CLK	$V_{IN} = V_{CC} = 3.465V$		150	$\mu A$
		nCLK	$V_{IN} = V_{CC} = 3.465V$		5	$\mu A$
$I_{IL}$	Input Low Current	CLK	$V_{IN} = 0V, V_{CC} = 3.465V$	-5		$\mu A$
		nCLK	$V_{IN} = 0V, V_{CC} = 3.465V$	-150		$\mu A$
$V_{PP}$	Peak-to-Peak Input Voltage		0.15		1.3	V
$V_{CMR}$	Common Mode Input Voltage; NOTE 1, 2		$V_{EE} + 0.5$		$V_{CC} - 0.85$	V

NOTE 1: Common mode voltage is defined as  $V_{IH}$ .

NOTE 2: For single ended applications, the maximum input voltage for CLK and nCLK is  $V_{CC} + 0.3V$ .



**TABLE 4D. LVPECL DC CHARACTERISTICS,  $V_{CC} = V_{CCO} = 3.3V \pm 5\%$ ,  $T_A = 0^\circ C$  TO  $70^\circ C$**

Symbol	Parameter	Test Conditions	Minimum	Typical	Maximum	Units
$I_{IH}$	Input High Current	PCLK	$V_{CC} = V_{IN} = 3.465V$		150	$\mu A$
		nPCLK	$V_{CC} = V_{IN} = 3.465V$		5	$\mu A$
$I_{IL}$	Input Low Current	PCLK	$V_{CC} = 3.465V, V_{IN} = 0V$	-5		$\mu A$
		nPCLK	$V_{CC} = 3.465V, V_{IN} = 0V$	-150		$\mu A$
$V_{PP}$	Peak-to-Peak Input Voltage		0.3		1	V
$V_{CMR}$	Common Mode Input Voltage; NOTE 1, 2		$V_{EE} + 1.5$		$V_{CC}$	V
$V_{OH}$	Output High Voltage; NOTE 3		$V_{CCO} - 1.4$		$V_{CCO} - 0.9$	V
$V_{OL}$	Output Low Voltage; NOTE 3		$V_{CCO} - 2.0$		$V_{CCO} - 1.7$	V
$V_{SWING}$	Peak-to-Peak Voltage Swing		0.6		1.0	V

NOTE 1: Common mode voltage is defined as  $V_{IH}$ .

NOTE 2: For single ended applications, the maximum input voltage for PCLK, nPCLK is  $V_{CC} + 0.3V$ .

NOTE 3: Outputs terminated with  $50\Omega$  to  $V_{CCO} - 2V$ .

**TABLE 5. AC CHARACTERISTICS,  $V_{CC} = V_{CCO} = 3.3V \pm 5\%$ ,  $T_A = 0^\circ C$  TO  $70^\circ C$**

Symbol	Parameter	Test Conditions	Minimum	Typical	Maximum	Units
$f_{MAX}$	Output Frequency				500	MHz
$t_{PD}$	Propagation Delay; NOTE 1	$f \leq 500MHz$	1.3		2.5	ns
$t_{sk(o)}$	Output Skew; NOTE 2, 4				50	ps
$t_{sk(pp)}$	Part-to-Part Skew; NOTE 3, 4				250	ps
$t_R$	Output Rise Time	20% to 80% @ 50MHz	300		700	ps
$t_F$	Output Fall Time	20% to 80% @ 50MHz	300		700	ps
odc	Output Duty Cycle	$0 \leq f \leq 266MHz$	48	50	52	%
		$266 \leq f \leq 500MHz$	47	50	53	%

All parameters measured at 500MHz unless noted otherwise.

NOTE 1: Measured from the differential input crossing point to the differential output crossing point.

NOTE 2: Defined as skew between outputs at the same supply voltage and with equal load conditions. Measured at the output differential cross points.

NOTE 3: Defined as skew between outputs on different devices operating at the same supply voltages and with equal load conditions. Using the same type of inputs on each device, the outputs are measured at the differential cross points.

NOTE 4: This parameter is defined in accordance with JEDEC Standard 65.



## PARAMETER MEASUREMENT INFORMATION

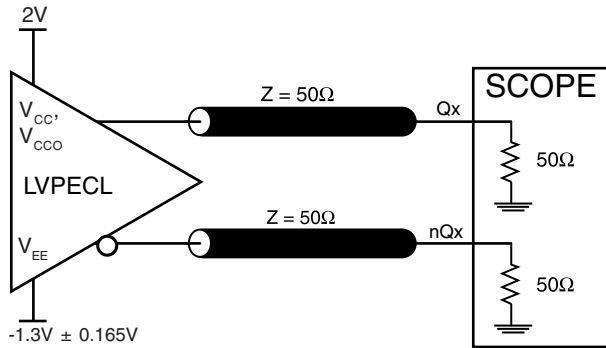

**3.3V OUTPUT LOAD AC TEST CIRCUIT**

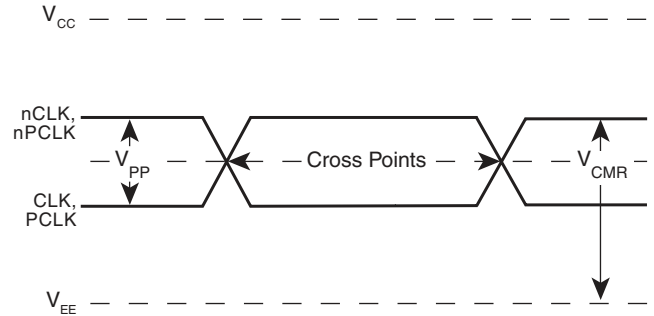

**DIFFERENTIAL INPUT LEVEL**

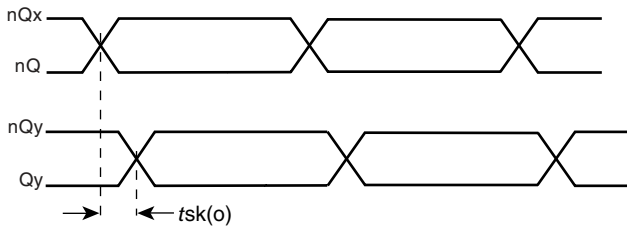

**OUTPUT SKEW**

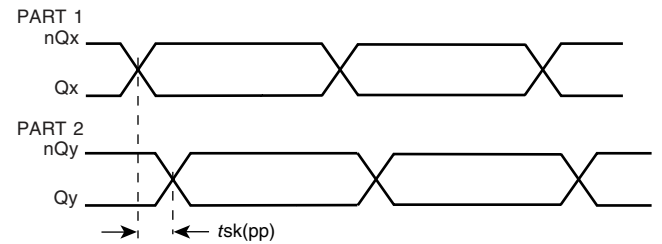

**PART-TO-PART SKEW**

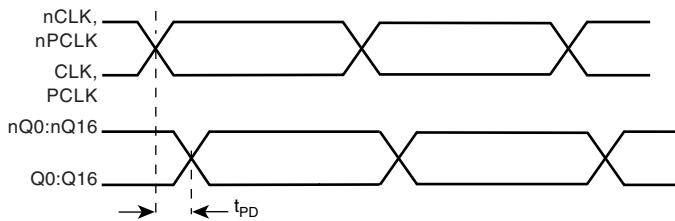

**PROPAGATION DELAY**

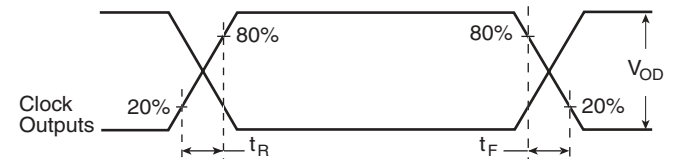

**OUTPUT RISE/FALL TIME**

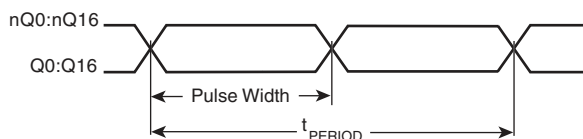

$$odc = \frac{t_{PW}}{t_{PERIOD}}$$

**OUTPUT DUTY CYCLE/PULSE WIDTH/PERIOD**



## APPLICATION INFORMATION

### WIRING THE DIFFERENTIAL INPUT TO ACCEPT SINGLE ENDED LEVELS

Figure 2 shows how the differential input can be wired to accept single ended levels. The reference voltage  $V_{REF} = V_{CC}/2$  is generated by the bias resistors R1, R2 and C1. This bias circuit should be located as close as possible to the input pin. The ratio of R1 and R2 might need to be adjusted to position the  $V_{REF}$  in the center of the input voltage swing. For example, if the input clock swing is only 2.5V and  $V_{CC} = 3.3V$ ,  $V_{REF}$  should be 1.25V and  $R2/R1 = 0.609$ .

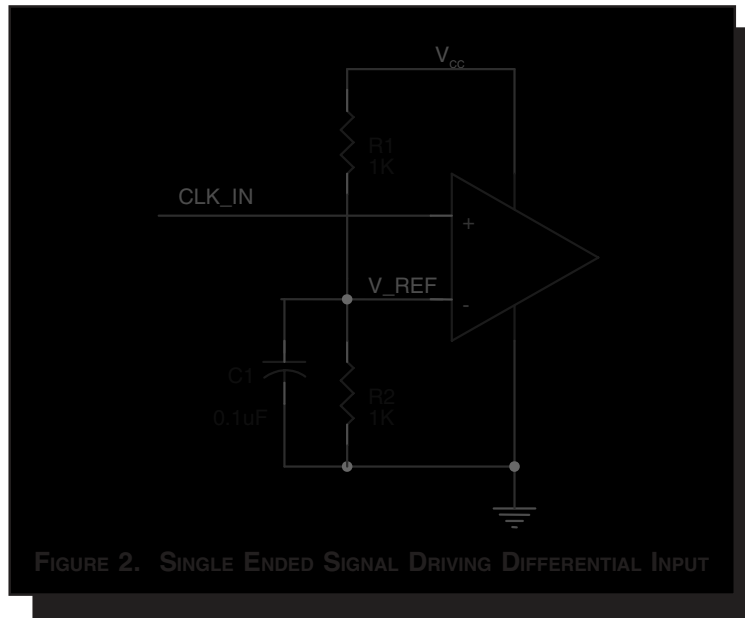

### TERMINATION FOR LVPECL OUTPUTS

The clock layout topology shown below is a typical termination for LVPECL outputs. The two different layouts mentioned are recommended only as guidelines.

FOUT and nFOUT are low impedance follower outputs that generate ECL/LVPECL compatible outputs. Therefore, terminating resistors (DC current path to ground) or current sources must be used for functionality. These outputs are designed to drive

50Ω transmission lines. Matched impedance techniques should be used to maximize operating frequency and minimize signal distortion. Figures 3A and 3B show two different layouts which are recommended only as guidelines. Other suitable clock layouts may exist and it would be recommended that the board designers simulate to guarantee compatibility across all printed circuit and clock component process variations.

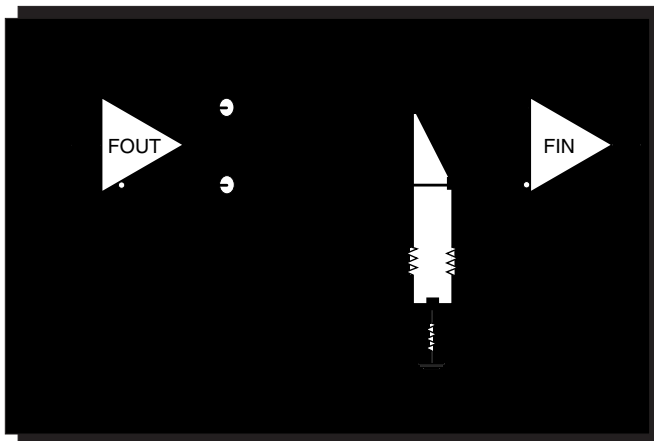

FIGURE 3A. LVPECL OUTPUT TERMINATION

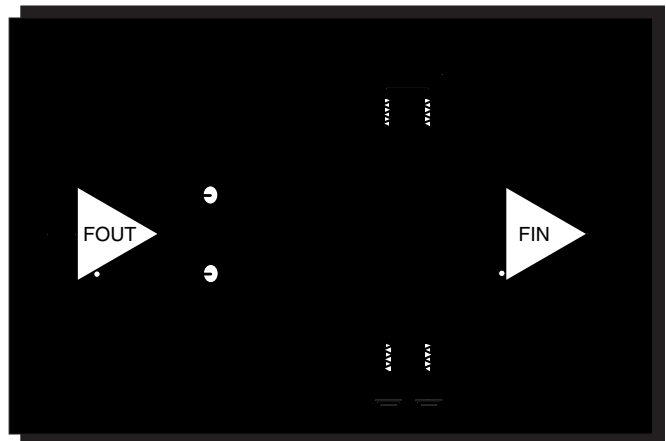

FIGURE 3B. LVPECL OUTPUT TERMINATION



## POWER CONSIDERATIONS

This section provides information on power dissipation and junction temperature for the ICS8532AY-01. Equations and example calculations are also provided.

### 1. Power Dissipation.

The total power dissipation for the ICS8532AY-01 is the sum of the core power plus the power dissipated in the load(s). The following is the power dissipation for  $V_{CC} = 3.3V + 5\% = 3.465V$ , which gives worst case results.

**NOTE:** Please refer to Section 3 for details on calculating power dissipated in the load.

- Power (core)<sub>MAX</sub> =  $V_{CC\_MAX} * I_{EE\_MAX} = 3.465V * 150mA = 519.8mW$
- Power (outputs)<sub>MAX</sub> = **30mW/Loaded Output pair**  
If all outputs are loaded, the total power is  $17 * 30mW = 510mW$

$$\text{Total Power}_{MAX} (3.465V, \text{ with all outputs switching}) = 519.8mW + 510mW = \mathbf{1029.8mW}$$

### 2. Junction Temperature.

Junction temperature,  $T_j$ , is the temperature at the junction of the bond wire and bond pad and directly affects the reliability of the device. The maximum recommended junction temperature for HiPerClockS™ devices is 125°C.

The equation for  $T_j$  is as follows:  $T_j = \theta_{JA} * Pd\_total + T_A$

$T_j$  = Junction Temperature

$\theta_{JA}$  = Junction-to-Ambient Thermal Resistance

$Pd\_total$  = Total Device Power Dissipation (example calculation is in section 1 above)

$T_A$  = Ambient Temperature

In order to calculate junction temperature, the appropriate junction-to-ambient thermal resistance  $\theta_{JA}$  must be used. Assuming a moderate air flow of 200 linear feet per minute and a multi-layer board, the appropriate value is 36.4°C/W per Table 6 below.

Therefore,  $T_j$  for an ambient temperature of 70°C with all outputs switching is:

$$70^\circ C + 1.030W * 36.4^\circ C/W = 107.5^\circ C. \text{ This is well below the limit of } 125^\circ C$$

This calculation is only an example.  $T_j$  will obviously vary depending on the number of loaded outputs, supply voltage, air flow, and the type of board (single layer or multi-layer).

**TABLE 6. THERMAL RESISTANCE  $\theta_{JA}$  FOR 52-PIN LQFP FORCED CONVECTION**

$\theta_{JA}$ by Velocity (Linear Feet per Minute)			
	0	200	500
Single-Layer PCB, JEDEC Standard Test Boards	58.0°C/W	47.1°C/W	42.0°C/W
Multi-Layer PCB, JEDEC Standard Test Boards	42.3°C/W	36.4°C/W	34.0°C/W

**NOTE:** Most modern PCB designs use multi-layered boards. The data in the second row pertains to most designs.





### 3. Calculations and Equations.

The purpose of this section is to derive the power dissipated into the load.

LVPECL output driver circuit and termination are shown in *Figure 4*.

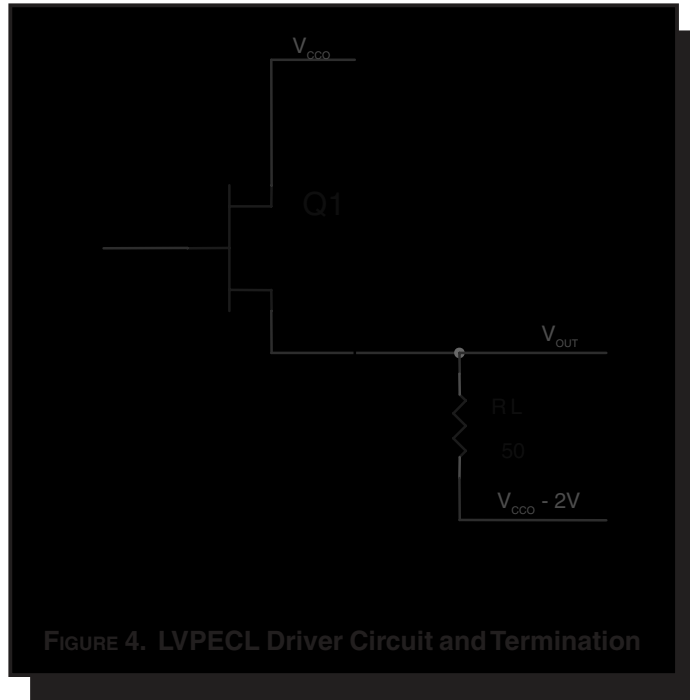

To calculate worst case power dissipation into the load, use the following equations which assume a 50Ω load, and a termination voltage of  $V_{CC0} - 2V$ .

- For logic high,  $V_{OUT} = V_{OH\_MAX} = V_{CC0\_MAX} - 0.9V$

$$(V_{CC0\_MAX} - V_{OH\_MAX}) = 0.9V$$

- For logic low,  $V_{OUT} = V_{OL\_MAX} = V_{CC0\_MAX} - 1.7V$

$$(V_{CC0\_MAX} - V_{OL\_MAX}) = 1.7V$$

$Pd\_H$  is power dissipation when the output drives high.  
 $Pd\_L$  is the power dissipation when the output drives low.

$$Pd\_H = [(V_{OH\_MAX} - (V_{CC0\_MAX} - 2V))/R_L] * (V_{CC0\_MAX} - V_{OH\_MAX}) = [(2V - (V_{CC0\_MAX} - V_{OH\_MAX}))/R_L] * (V_{CC0\_MAX} - V_{OH\_MAX}) = [(2V - 0.9V)/50\Omega] * 0.9V = 19.8mW$$

$$Pd\_L = [(V_{OL\_MAX} - (V_{CC0\_MAX} - 2V))/R_L] * (V_{CC0\_MAX} - V_{OL\_MAX}) = [(2V - (V_{CC0\_MAX} - V_{OL\_MAX}))/R_L] * (V_{CC0\_MAX} - V_{OL\_MAX}) = [(2V - 1.7V)/50\Omega] * 1.7V = 10.2mW$$

Total Power Dissipation per output pair =  $Pd\_H + Pd\_L = 30mW$

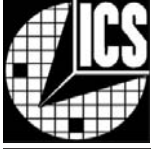

## RELIABILITY INFORMATION

TABLE 7.  $\theta_{JA}$  vs. AIR FLOW TABLE FOR 52 LEAD LQFP

$\theta_{JA}$ by Velocity (Linear Feet per Minute)			
	0	200	500
Single-Layer PCB, JEDEC Standard Test Boards	58.0°C/W	47.1°C/W	42.0°C/W
Multi-Layer PCB, JEDEC Standard Test Boards	42.3°C/W	36.4°C/W	34.0°C/W

**NOTE:** Most all modern PCB designs use multi-layered boards, so the data in the second row will pertain to most designs

### TRANSISTOR COUNT

The transistor count for ICS8532AY-01 is: 1398



PACKAGE OUTLINE - Y SUFFIX FOR 52 LEAD LQFP

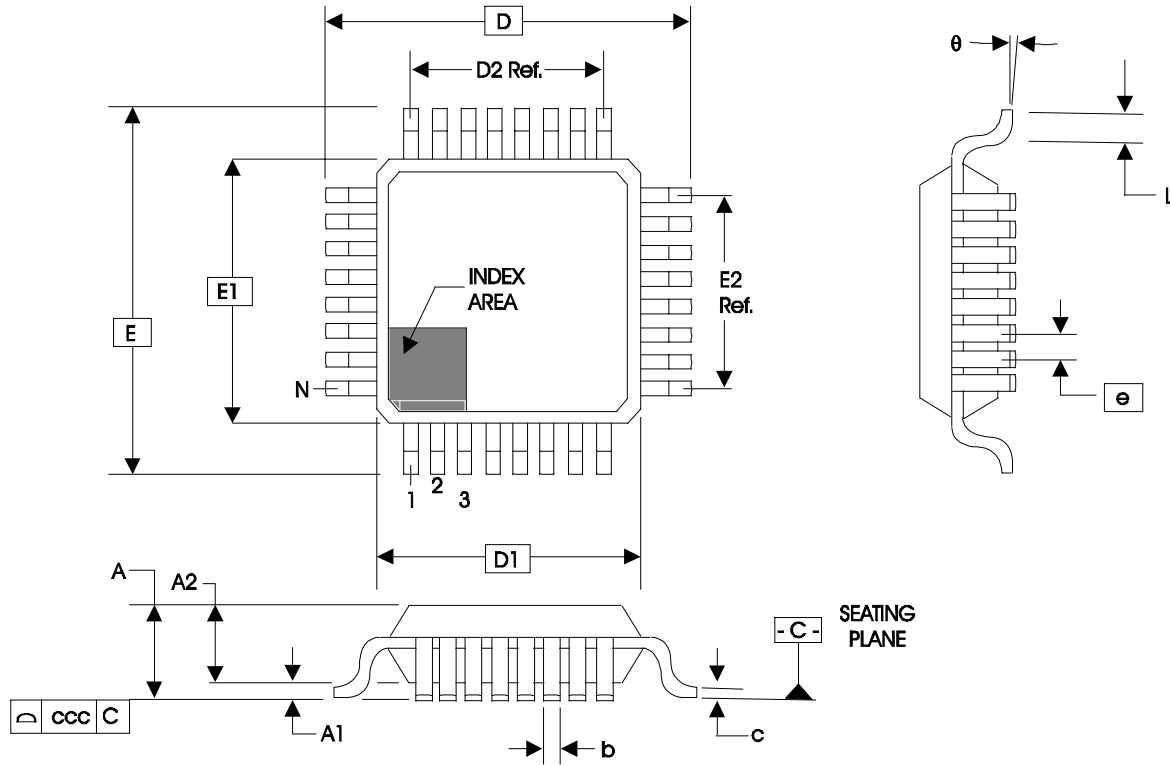

TABLE 8. PACKAGE DIMENSIONS

JEDEC VARIATION ALL DIMENSIONS IN MILLIMETERS			
SYMBOL	BCC		
	MINIMUM	NOMINAL	MAXIMUM
N	52		
A	--	--	1.60
A1	0.05	--	0.15
A2	1.35	1.40	1.45
b	0.22	0.32	0.38
c	0.09	--	0.20
D	12.00 BASIC		
D1	10.00 BASIC		
E	12.00 BASIC		
E1	10.00 BASIC		
e	0.65 BASIC		
L	0.45	--	0.75
$\theta$	0°	--	7°
ccc	--	--	0.08

Reference Document: JEDEC Publication 95, MS-026



Integrated  
Circuit  
Systems, Inc.

# ICS8532AY-01

## LOW SKEW, 1-TO-17 DIFFERENTIAL-TO-3.3V LVPECL FANOUT BUFFER

**TABLE 9. ORDERING INFORMATION**

Part/Order Number	Marking	Package	Shipping Packaging	Temperature
8532AY-01	ICS8532AY-01	52 Lead LQFP	tray	0°C to 70°C
8532AY-01T	ICS8532AY-01	52 Lead LQFP	500 tape & reel	0°C to 70°C
8532AY-01LF	ICS8532AY-01LF	Lead-Free, 52 Lead LQFP	tray	0°C to 70°C
8532AY-01LFT	ICS8532AY-01LF	Lead-Free, 52 Lead LQFP	500 tape & reel	0°C to 70°C

NOTE: Parts that are ordered with an "LF" suffix to the part number are the Pb-Free configuration and are RoHS compliant.

The aforementioned trademark, HiPerClockS™ is a trademark of Integrated Circuit Systems, Inc. or its subsidiaries in the United States and/or other countries. While the information presented herein has been checked for both accuracy and reliability, Integrated Circuit Systems, Incorporated (ICS) assumes no responsibility for either its use or for infringement of any patents or other rights of third parties, which would result from its use. No other circuits, patents, or licenses are implied. This product is intended for use in normal commercial applications. Any other applications such as those requiring extended temperature range, high reliability, or other extraordinary environmental requirements are not recommended without additional processing by ICS. ICS reserves the right to change any circuitry or specifications without notice. ICS does not authorize or warrant any ICS product for use in life support devices or critical medical instruments.



REVISION HISTORY SHEET				
Rev	Table	Page	Description of Change	Date
B		3	Revised Figure 1, CLK_EN Timing Diagram.	10/18/01
B		3	Revised Figure 1, CLK_EN Timing Diagram.	11/2/01
B	1	1 2	Revised Pin Assignment. Revised Pin Description table.	5/24/02
B		9	Added "Termination for LVPECL Outputs" section.	5/28/02
B			Changed P/N (throughout the data sheet) from ICS8532-01 to ICS8532AY-01	6/26/02
B	T1, T4A	2 5	Pin Description & Power Supply table - $V_{CC}$ description changed to "Core supply pin" from "Positive supply pin". Output Load Test Circuit diagram - corrected $V_{EE}$ equation to read, $V_{EE} = -1.3V \pm 0.165V$ from $V_{EE} = -1.3V \pm 0.135V$ .	10/03/02
B		11	Revised Package Outline diagram and the Package Dimensions table.	11/20/02
C	T2	1 2	Block Diagram reversed CLK/nCLK & PCLK/nPCLK labels. Pin Characteristics Table - $C_{IN}$ changed 4pF max to 4pF typical.	12/20/04
C	T1	1 2	Block Diagram - switched PCLK/nPCLK with CLK/nCLK. Pin Descriptions table - pin 7 corrected description to read "When HIGH, selects PCLK, nPCLK... When LOW, selects CLK, nCLK..."	2/22/05
D	T4D	5	LVPECL DC Characteristics Table -corrected $V_{OH}$ max. from $V_{CCO} - 1.0V$ to $V_{CCO} - 0.9V$ ; and $V_{SWING}$ max. from 0.85V to 1.0V.	4/12/07
		8 - 9	Power Considerations - corrected power dissipation to reflect $V_{OH}$ max in Table 4D.	
	T9	12	Ordering Information Table - added lead-free Part/Order Number, Marking, and note.	