

APPROVED: _____
 DATE: _____ TITLE: _____

Rev	AWO #	Description	Date	Appr
-		RELEASED	11/2/21	
A		UPDATED SPEC.	11/8/21	JJ/RC

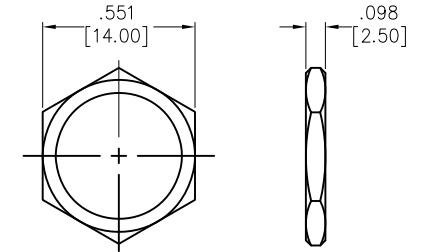

NUT

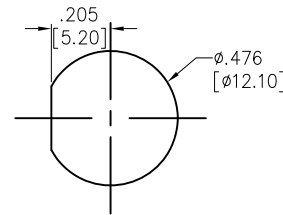
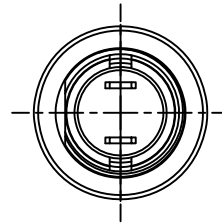
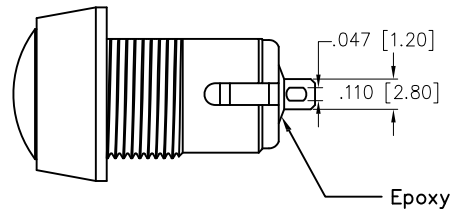
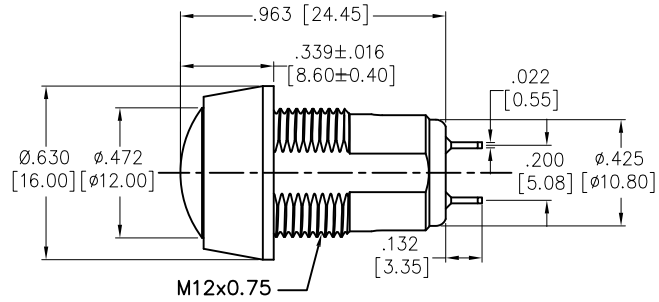
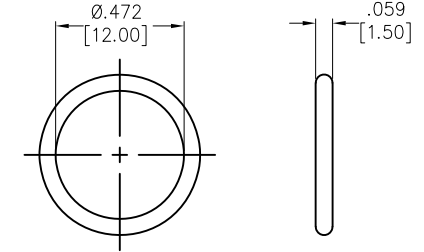

O-RING

RECOMMENDED
 PANEL CUT-OUT

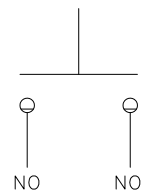

CIRCUIT DIAGRAM
 (SPST)

SPECIFICATIONS:

Material:
 Bushing: Aluminum Alloy, Nickel plated
 Bushing Color: Black
 Contact Material: Copper Alloy,
 Plating: Gold over Silver
 Electrical:
 Switch Rating: 100mA @ 24V DC
 2A @ 125V AC
 Contact resistance: 50 mΩ max initial.
 Insulation resistance: 1G ohms min @ 500 VDC
 Dielectric withstanding voltage: 1000 VAC for 1 minute
 Electrical Life: 1,000,000 cycles min.
 Temperature Rating:
 Operating temperature: -30°C to +85°C
 Environmental:

Water proof: IP67
 Lead free, RoHS compliant



UNLESS OTHERWISE SPECIFIED ALL DIMENSIONS
 ARE INCHES [MM]. TOLERANCES: EXCEPT AS NOTED

INCHES	HOLES
.x ±.10	ØX ±.10
.xx ±.020	ØXX ±.015
.xxx ±.015	ØXXX ±.010



909 Rahway Avenue,
 Union, NJ 07083
 Phone: 908-687-5000
 Fax: 908-687-5710

DRAWN	JJ	11/2/21
CHECKED	RC	11/2/21
APPROVED		

TITLE
 SWITCH, ANTI-VANDAL SEALED, PUSH BUTTON,
 SOLDER SPST, 12mm, MOMENTARY

THIS DRAWING CONTAINS INFORMATION THAT IS PROPRIETARY
 AND SHOULD NOT BE USED WITHOUT PRIOR WRITTEN
 PERMISSION FROM ADAM TECH

SIZE	PART NO.	REV.
X	SW-PB7-04MB4WARM	A
REF: S00198T	SCALE: NTS	SHEET 1 OF 1