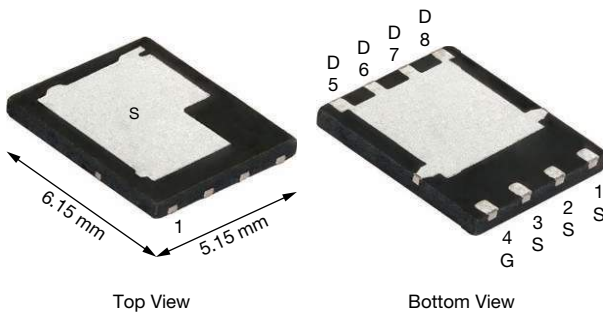

## N-Channel 100 V (D-S) MOSFET

**PowerPAK® SO-8DC**

**FEATURES**

- TrenchFET® Gen IV power MOSFET
- Very low  $R_{DS}$  x  $Q_g$  figure-of-merit (FOM)
- Tuned for the lowest  $R_{DS}$  x  $Q_{OSS}$  FOM
- 100 %  $R_g$  and UIS tested
- Material categorization: for definitions of compliance please see [www.vishay.com/doc?99912](http://www.vishay.com/doc?99912)

**RoHS**  
 COMPLIANT  
 HALOGEN  
**FREE**
**APPLICATIONS**

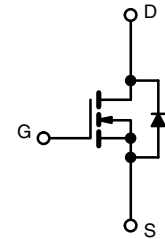
- Synchronous rectification
- Primary side switch
- DC/DC converters
- OR-ing
- Power supplies
- Motor drive control
- Battery and load switch



N-Channel MOSFET

PRODUCT SUMMARY	
$V_{DS}$ (V)	100
$R_{DS(on)}$ max. ( $\Omega$ ) at $V_{GS} = 10$ V	0.00480
$R_{DS(on)}$ max. ( $\Omega$ ) at $V_{GS} = 4.5$ V	0.00585
$Q_g$ typ. (nC)	42
$I_D$ (A)	95
Configuration	Single

ORDERING INFORMATION	
Package	PowerPAK SO-8DC
Lead (Pb)-free and halogen-free	SiDR170DP-T1-RE3

ABSOLUTE MAXIMUM RATINGS ( $T_A = 25$ °C, unless otherwise noted)			
PARAMETER	SYMBOL	LIMIT	UNIT
Drain-source voltage	$V_{DS}$	100	V
Gate-source voltage	$V_{GS}$	$\pm 20$	
Continuous drain current ( $T_J = 150$ °C)	$I_D$	$T_C = 25$ °C	95
		$T_C = 70$ °C	76
		$T_A = 25$ °C	23.2 <sup>b, c</sup>
		$T_A = 70$ °C	18.6 <sup>b, c</sup>
Pulsed drain current ( $t = 100$ $\mu$ s)	$I_{DM}$	200	A
Continuous source-drain diode current	$I_S$	$T_C = 25$ °C	
		$T_A = 25$ °C	5.6 <sup>b, c</sup>
Single pulse avalanche current	$I_{AS}$	35	mJ
Single pulse avalanche energy	$E_{AS}$	61.2	
Maximum power dissipation	$P_D$	$T_C = 25$ °C	125
		$T_C = 70$ °C	80
		$T_A = 25$ °C	6.25 <sup>b, c</sup>
		$T_A = 70$ °C	4 <sup>b, c</sup>
Operating junction and storage temperature range	$T_J, T_{stg}$	-55 to +150	°C
Soldering recommendations (peak temperature) <sup>c</sup>		260	

THERMAL RESISTANCE RATINGS					
PARAMETER	SYMBOL	TYPICAL	MAXIMUM	UNIT	
Maximum junction-to-ambient <sup>b</sup>	$R_{thJA}$	15	20	°C/W	
Maximum junction-to-case (drain)	$R_{thJC}$	0.8	1.0		
Maximum junction-to-case (source)	$R_{thJC}$	1.1	1.4		

**Notes**

- Package limited
- Surface mounted on 1" x 1" FR4 board
- $t = 10$  s
- See solder profile ([www.vishay.com/doc?73257](http://www.vishay.com/doc?73257)). The PowerPAK SO-8 is a leadless package. The end of the lead terminal is exposed copper (not plated) as a result of the singulation process in manufacturing. A solder fillet at the exposed copper tip cannot be guaranteed and is not required to ensure adequate bottom side solder interconnection
- Rework conditions: manual soldering with a soldering iron is not recommended for leadless components
- Maximum under steady state conditions is 54 °C/W
- $T_C = 25$  °C



<b>SPECIFICATIONS</b> ( $T_J = 25\text{ }^\circ\text{C}$ , unless otherwise noted)						
PARAMETER	SYMBOL	TEST CONDITIONS	MIN.	TYP.	MAX.	UNIT
<b>Static</b>						
Drain-source breakdown voltage	$V_{DS}$	$V_{GS} = 0\text{ V}, I_D = 250\text{ }\mu\text{A}$	100	-	-	V
$V_{DS}$ temperature coefficient	$\Delta V_{DS}/T_J$	$I_D = 10\text{ mA}$	-	65	-	mV/ $^\circ\text{C}$
$V_{GS(th)}$ temperature coefficient	$\Delta V_{GS(th)}/T_J$	$I_D = 250\text{ }\mu\text{A}$	-	-5.5	-	
Gate-source threshold voltage	$V_{GS(th)}$	$V_{DS} = V_{GS}, I_D = 250\text{ }\mu\text{A}$	1	-	2.5	V
Gate-source leakage	$I_{GSS}$	$V_{DS} = 0\text{ V}, V_{GS} = \pm 20\text{ V}$	-	-	100	nA
Zero gate voltage drain current	$I_{DSS}$	$V_{DS} = 100\text{ V}, V_{GS} = 0\text{ V}$	-	-	1	$\mu\text{A}$
		$V_{DS} = 100\text{ V}, V_{GS} = 0\text{ V}, T_J = 70\text{ }^\circ\text{C}$	-	-	15	
On-state drain current <sup>a</sup>	$I_{D(on)}$	$V_{DS} \geq 10\text{ V}, V_{GS} = 10\text{ V}$	40	-	-	A
Drain-source on-state resistance <sup>a</sup>	$R_{DS(on)}$	$V_{GS} = 10\text{ V}, I_D = 20\text{ A}$	-	0.00400	0.00480	$\Omega$
		$V_{GS} = 4.5\text{ V}, I_D = 15\text{ A}$	-	0.00450	0.00585	
Forward transconductance <sup>a</sup>	$g_{fs}$	$V_{DS} = 15\text{ V}, I_D = 20\text{ A}$	-	85	-	S
<b>Dynamic <sup>b</sup></b>						
Input capacitance	$C_{ISS}$	$V_{DS} = 50\text{ V}, V_{GS} = 0\text{ V}, f = 1\text{ MHz}$	-	6195	-	pF
Output capacitance	$C_{OSS}$		-	383	-	
Reverse transfer capacitance	$C_{RSS}$		-	20	-	
Total gate charge	$Q_g$	$V_{DS} = 50\text{ V}, V_{GS} = 10\text{ V}, I_D = 20\text{ A}$	-	93	140	nC
		$V_{DS} = 50\text{ V}, V_{GS} = 4.5\text{ V}, I_D = 20\text{ A}$	-	42	63	
Gate-source charge	$Q_{gs}$		-	17	-	
Gate-drain charge	$Q_{gd}$		-	8.7	-	
Output charge	$Q_{OSS}$	$V_{DS} = 50\text{ V}, V_{GS} = 0\text{ V}$	-	69	-	
Gate resistance	$R_g$	$f = 1\text{ MHz}$	0.3	0.9	1.6	$\Omega$
Turn-on delay time	$t_{d(on)}$	$V_{DD} = 50\text{ V}, R_L = 2.5\text{ }\Omega, I_D \cong 20\text{ A}, V_{GEN} = 10\text{ V}, R_g = 1\text{ }\Omega$	-	12	24	ns
Rise time	$t_r$		-	7	14	
Turn-off delay time	$t_{d(off)}$		-	43	86	
Fall time	$t_f$		-	8	16	
Turn-on delay time	$t_{d(on)}$	$V_{DD} = 50\text{ V}, R_L = 2.5\text{ }\Omega, I_D \cong 20\text{ A}, V_{GEN} = 6\text{ V}, R_g = 1\text{ }\Omega$	-	18	36	
Rise time	$t_r$		-	10	20	
Turn-off delay time	$t_{d(off)}$		-	48	96	
Fall time	$t_f$		-	10	20	
<b>Drain-Source Body Diode Characteristics</b>						
Continuous source-drain diode current	$I_S$	$T_C = 25\text{ }^\circ\text{C}$	-	-	94	A
Pulse diode forward current	$I_{SM}$		-	-	200	
Body diode voltage	$V_{SD}$	$I_S = 5\text{ A}, V_{GS} = 0\text{ V}$	-	0.73	1.1	V
Body diode reverse recovery time	$t_{rr}$	$I_F = 20\text{ A}, di/dt = 100\text{ A}/\mu\text{s}, T_J = 25\text{ }^\circ\text{C}$	-	50	100	ns
Body diode reverse recovery charge	$Q_{rr}$		-	93	186	nC
Reverse recovery fall time	$t_a$		-	38	-	ns
Reverse recovery rise time	$t_b$		-	12	-	

**Notes**

- a. Pulse test; pulse width  $\leq 300\text{ }\mu\text{s}$ , duty cycle  $\leq 2\%$
- b. Guaranteed by design, not subject to production testing

Stresses beyond those listed under "Absolute Maximum Ratings" may cause permanent damage to the device. These are stress ratings only, and functional operation of the device at these or any other conditions beyond those indicated in the operational sections of the specifications is not implied. Exposure to absolute maximum rating conditions for extended periods may affect device reliability.



TYPICAL CHARACTERISTICS (25 °C, unless otherwise noted)

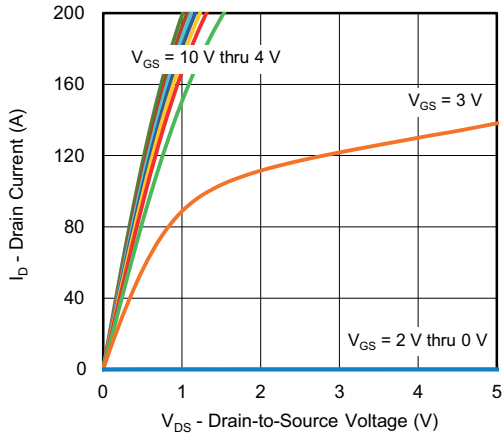

Output Characteristics

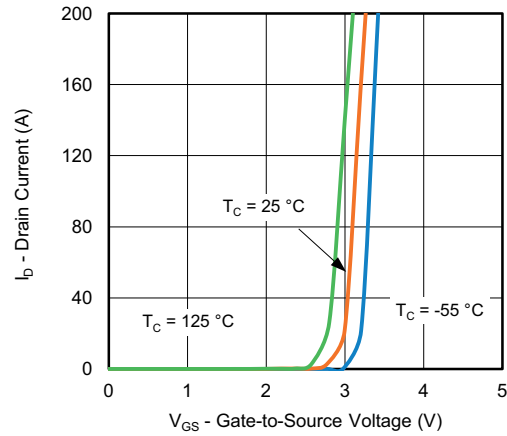

Transfer Characteristics

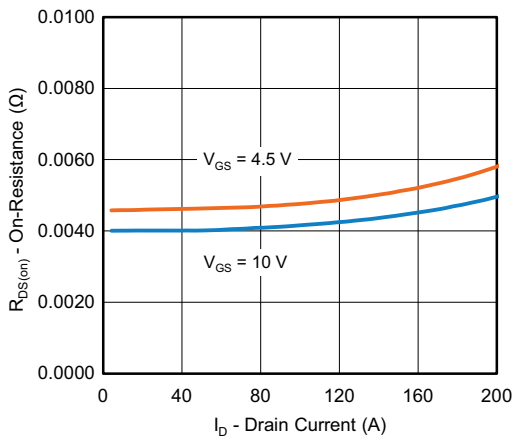

On-Resistance vs. Drain Current and Gate Voltage

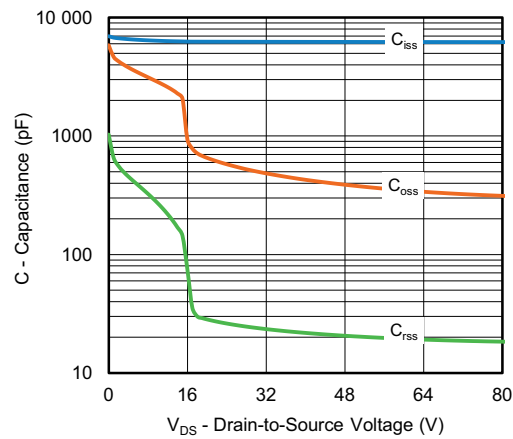

Capacitance

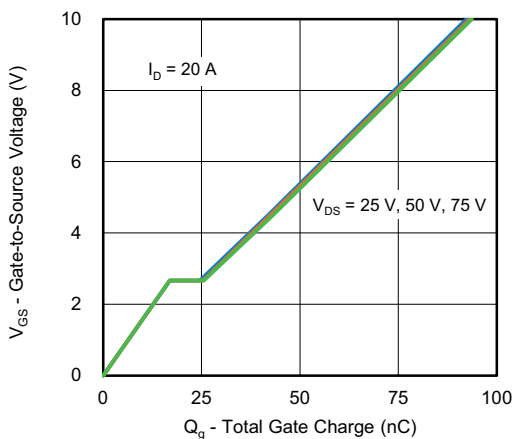

Gate Charge

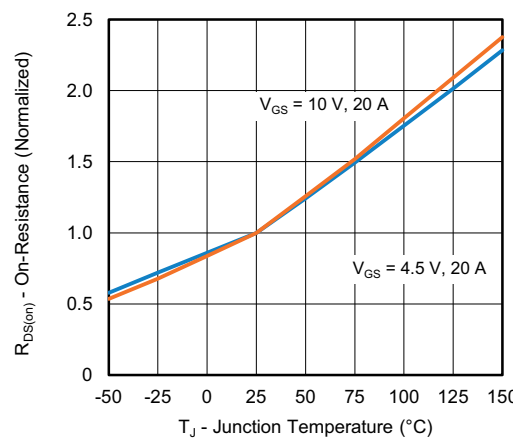

On-Resistance vs. Junction Temperature



**TYPICAL CHARACTERISTICS** (25 °C, unless otherwise noted)

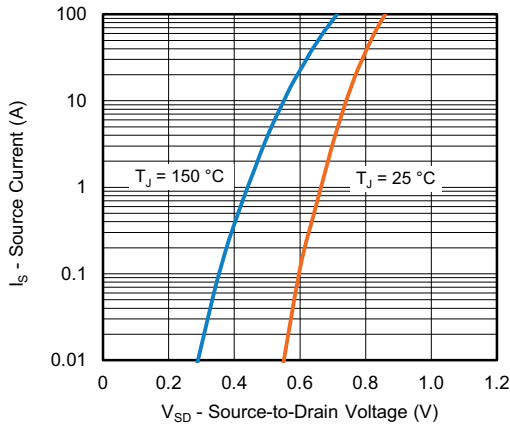

**Source-Drain Diode Forward Voltage**

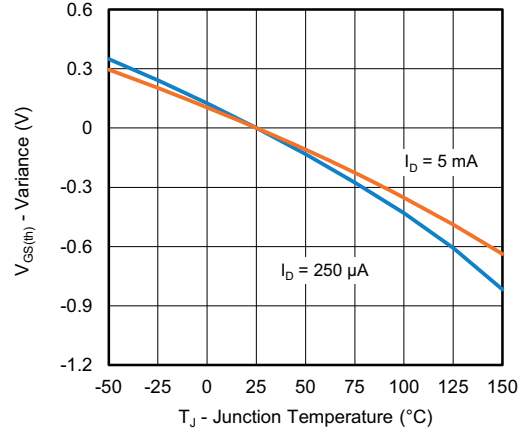

**Threshold Voltage**

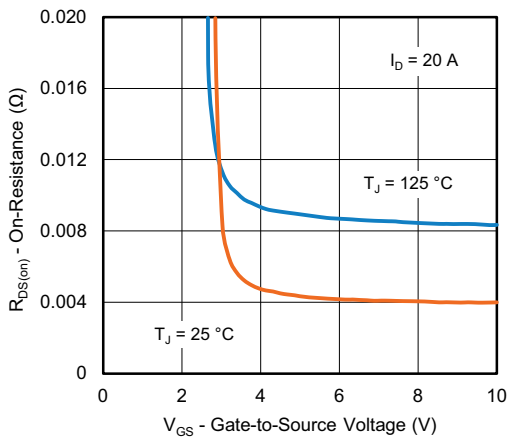

**On-Resistance vs. Gate-to-Source Voltage**

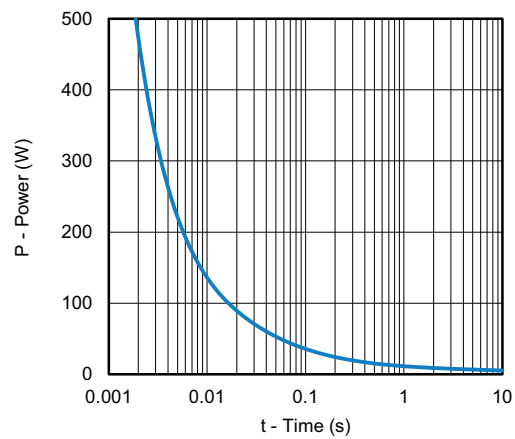

**Single Pulse Power, Junction-to-Ambient**

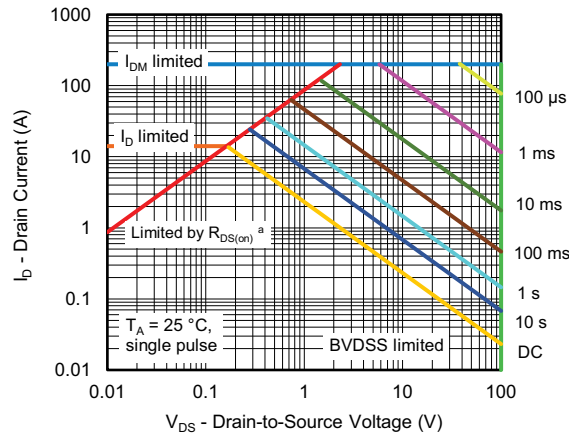

**Safe Operating Area, Junction-to-Ambient**

**Note**

a.  $V_{GS} >$  minimum  $V_{GS}$  at which  $R_{DS(on)}$  is specified



**TYPICAL CHARACTERISTICS** (25 °C, unless otherwise noted)

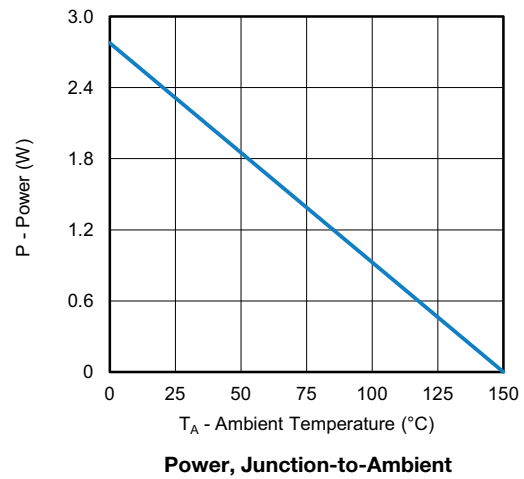
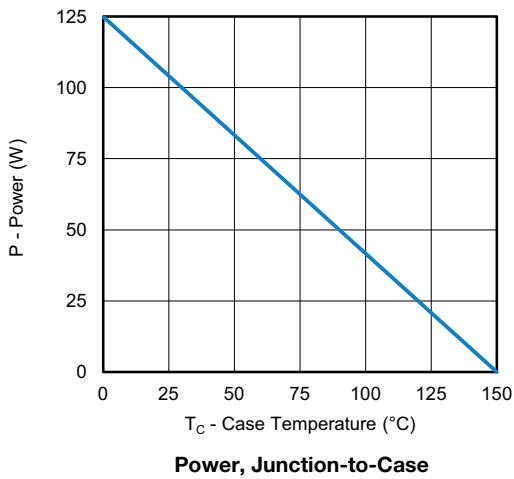
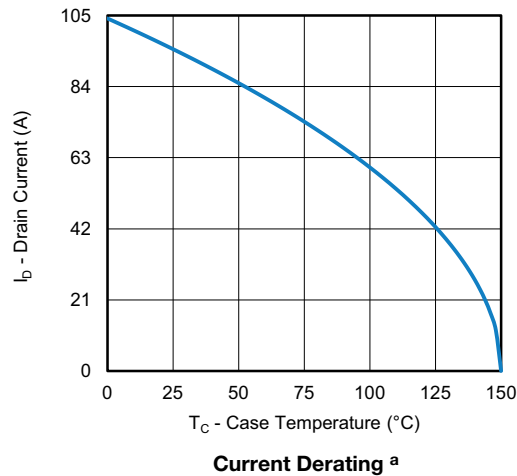

**Note**

- a. The power dissipation  $P_D$  is based on  $T_J$  max. = 150 °C, using junction-to-case thermal resistance, and is more useful in settling the upper dissipation limit for cases where additional heatsinking is used. It is used to determine the current rating, when this rating falls below the package limit



TYPICAL CHARACTERISTICS (25 °C, unless otherwise noted)

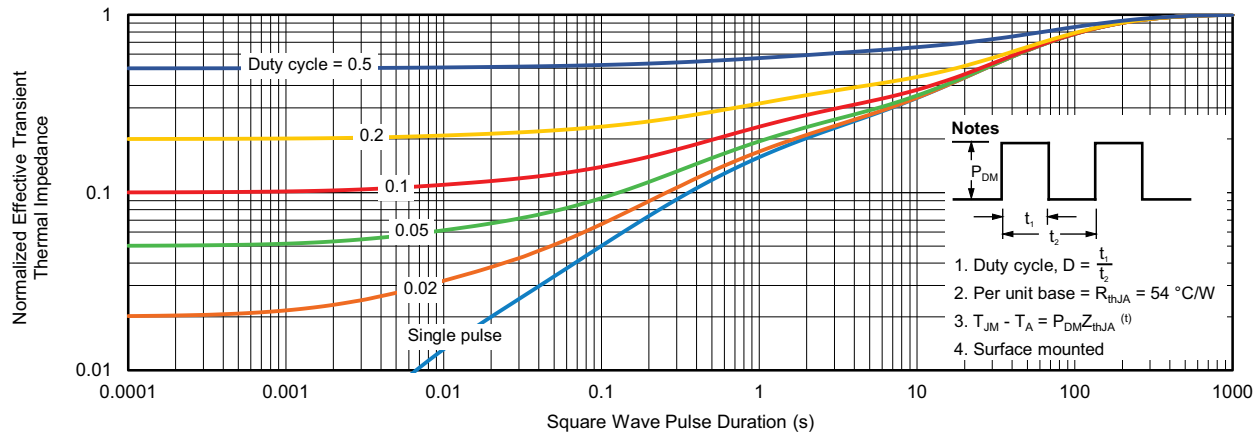

Normalized Thermal Transient Impedance, Junction-to-Ambient

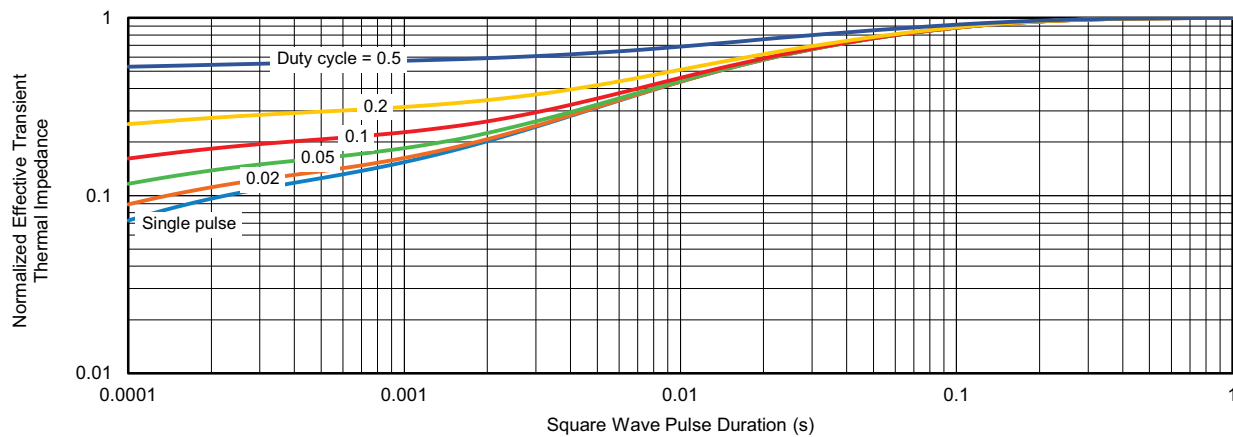

Normalized Thermal Transient Impedance, Junction-to-Case

Vishay Siliconix maintains worldwide manufacturing capability. Products may be manufactured at one of several qualified locations. Reliability data for Silicon Technology and Package Reliability represent a composite of all qualified locations. For related documents such as package / tape drawings, part marking, and reliability data, see [www.vishay.com/ppg?77513](http://www.vishay.com/ppg?77513).

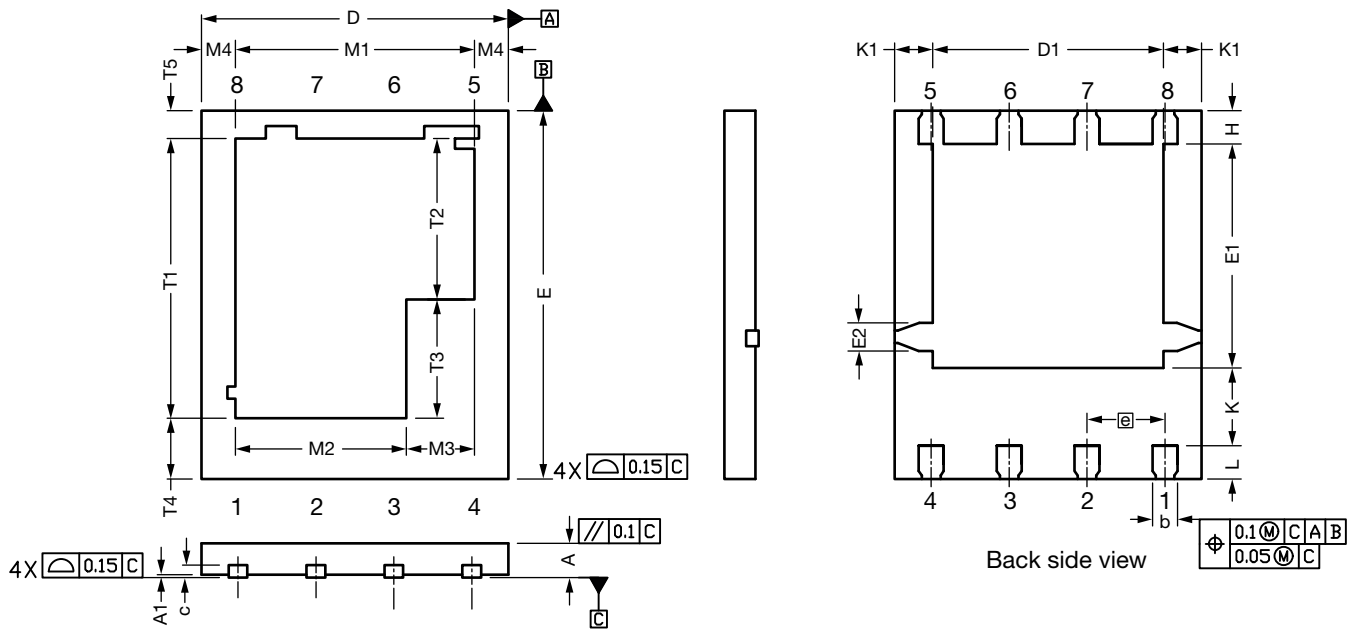
**PowerPAK® SO-8 Double Cooling Case Outline**

DIM.	MILLIMETERS			INCHES		
	MIN.	NOM.	MAX.	MIN.	NOM.	MAX.
A	0.51	0.56	0.61	0.020	0.022	0.024
A1	0.00	0.02	0.05	0.000	0.001	0.002
b	0.36	0.41	0.46	0.014	0.016	0.018
c	0.15	0.20	0.25	0.006	0.008	0.010
D	4.90	5.00	5.10	0.193	0.197	0.201
D1	3.71	3.76	3.81	0.146	0.148	0.150
e	1.27 BSC			0.050 BSC		
E	5.90	6.00	6.10	0.232	0.236	0.240
E1	3.60	3.65	3.70	0.142	0.144	0.146
E2	0.46 typ.			0.018 typ.		
H	0.49	0.54	0.59	0.019	0.021	0.023
K	1.22	1.27	1.32	0.048	0.050	0.052
K1	0.64 typ.			0.025 typ.		
L	0.49	0.54	0.59	0.019	0.021	0.023
M1	3.85	3.90	3.95	0.152	0.154	0.156
M2	2.74	2.79	2.84	0.108	0.110	0.112
M3	1.06	1.11	1.16	0.042	0.044	0.046
M4	0.56 typ.			0.022 typ.		
N	8			8		
T1	4.51	4.56	4.61	0.178	0.180	0.182
T2	2.58	2.63	2.68	0.102	0.104	0.106
T3	1.88	1.93	1.98	0.074	0.076	0.078
T4	0.97 typ.			0.038 typ.		
T5	0.48 typ.			0.019 typ.		

ECN: T21-0014-Rev. B, 08-Feb-2021

DWG: 6048

## RECOMMENDED MINIMUM PADS FOR PowerPAK® SO-8 Single

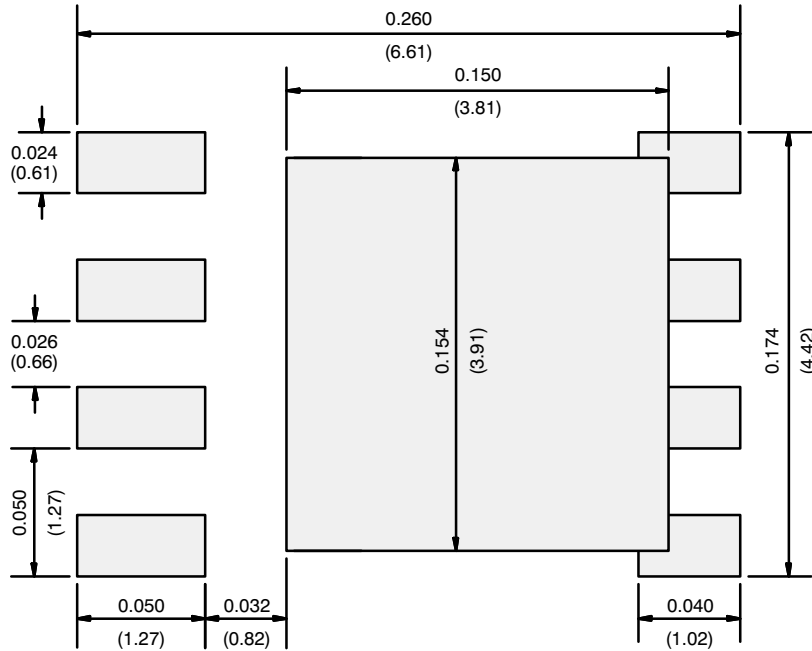

Recommended Minimum Pads  
Dimensions in Inches/(mm)

[Return to Index](#)





## Disclaimer

ALL PRODUCT, PRODUCT SPECIFICATIONS AND DATA ARE SUBJECT TO CHANGE WITHOUT NOTICE TO IMPROVE RELIABILITY, FUNCTION OR DESIGN OR OTHERWISE.

Vishay Intertechnology, Inc., its affiliates, agents, and employees, and all persons acting on its or their behalf (collectively, "Vishay"), disclaim any and all liability for any errors, inaccuracies or incompleteness contained in any datasheet or in any other disclosure relating to any product.

Vishay makes no warranty, representation or guarantee regarding the suitability of the products for any particular purpose or the continuing production of any product. To the maximum extent permitted by applicable law, Vishay disclaims (i) any and all liability arising out of the application or use of any product, (ii) any and all liability, including without limitation special, consequential or incidental damages, and (iii) any and all implied warranties, including warranties of fitness for particular purpose, non-infringement and merchantability.

Statements regarding the suitability of products for certain types of applications are based on Vishay's knowledge of typical requirements that are often placed on Vishay products in generic applications. Such statements are not binding statements about the suitability of products for a particular application. It is the customer's responsibility to validate that a particular product with the properties described in the product specification is suitable for use in a particular application. Parameters provided in datasheets and / or specifications may vary in different applications and performance may vary over time. All operating parameters, including typical parameters, must be validated for each customer application by the customer's technical experts. Product specifications do not expand or otherwise modify Vishay's terms and conditions of purchase, including but not limited to the warranty expressed therein.

Hyperlinks included in this datasheet may direct users to third-party websites. These links are provided as a convenience and for informational purposes only. Inclusion of these hyperlinks does not constitute an endorsement or an approval by Vishay of any of the products, services or opinions of the corporation, organization or individual associated with the third-party website. Vishay disclaims any and all liability and bears no responsibility for the accuracy, legality or content of the third-party website or for that of subsequent links.

Except as expressly indicated in writing, Vishay products are not designed for use in medical, life-saving, or life-sustaining applications or for any other application in which the failure of the Vishay product could result in personal injury or death. Customers using or selling Vishay products not expressly indicated for use in such applications do so at their own risk. Please contact authorized Vishay personnel to obtain written terms and conditions regarding products designed for such applications.

No license, express or implied, by estoppel or otherwise, to any intellectual property rights is granted by this document or by any conduct of Vishay. Product names and markings noted herein may be trademarks of their respective owners.