

51864-8 ✓ ACTIVE



PIDG

TE Internal #: 51864-8

Ring Terminals & Spade Terminals, Ring Tongue, 14 AWG Wire Size, 2.15 mm² Wire Size, 4234 CMA Wire Size, Stud Size M3.5 / #6, PIDG

[View on TE.com >](#)

Terminals & Splices > Ring Terminals & Spade Terminals > PIDG Ring Tongue Terminals

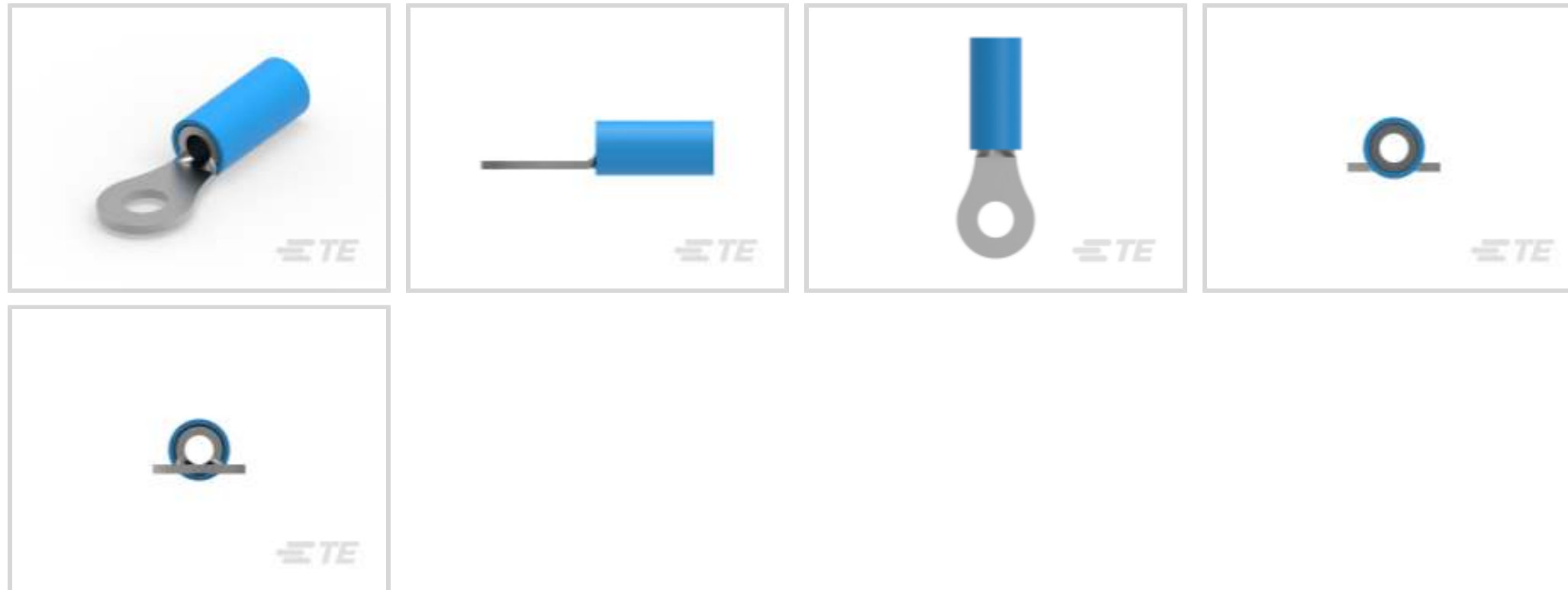

Ring & Spade Terminal Type: **Ring Tongue**

Wire Size: **4234 CMA**

Stud Size: **#6, M3.5**

[All PIDG Ring Tongue Terminals \(421\)](#)

Features

Product Type Features

Stud Size	#6, M3.5
Sealable	No
Wire Insulation Support Retention Type	Insulation Restriction

Configuration Features

Number of Holes	1
-----------------	---

Electrical Characteristics

Voltage Rating	300 V
----------------	-------

Body Features

Product Weight	1.028 g
Insulation Sleeve Color	Blue
Stripe Color	Green

Contact Features

Military Part Class	Class I
---------------------	---------



Ring & Spade Terminal Type	Ring Tongue
----------------------------	-------------

Barrel Type	Closed
-------------	--------

Terminal Orientation	Straight
----------------------	----------

Terminal Plating Material	Tin
---------------------------	-----

Mechanical Attachment

Wire Insulation Support	With
-------------------------	------

Dimensions

Wire Size	4234 CMA
-----------	----------

Stud Diameter	3.68 mm[.145 in]
---------------	------------------

Tongue Thickness	.79 mm[.031 in]
------------------	-----------------

Product Length	23 mm[.906 in]
----------------	----------------

Compatible Insulation Diameter (Max)	3.3 mm[.13 in]
--------------------------------------	----------------

Compatible Insulation Diameter Range	1.98 – 3.3 mm[.078 – .13 in]
--------------------------------------	------------------------------

Usage Conditions

Insulation Option	Partially Insulated
-------------------	---------------------

Operating Temperature Range	105 °C[221 °F]
-----------------------------	----------------

Operation/Application

Compatible With Wire Base Material	Copper
------------------------------------	--------

Compatible With Wire Plating Material	Tin
---------------------------------------	-----

Industry Standards

Government Qualified Terminal	Yes
-------------------------------	-----

Packaging Features

Packaging Quantity	1000
--------------------	------

Packaging Method	Loose Piece
------------------	-------------

Product Compliance

[For compliance documentation, visit the product page on TE.com>](#)

EU RoHS Directive 2011/65/EU	Compliant
------------------------------	-----------

EU ELV Directive 2000/53/EC	Compliant
-----------------------------	-----------

China RoHS 2 Directive MIIT Order No 32, 2016	No Restricted Materials Above Threshold
---	---

EU REACH Regulation (EC) No. 1907/2006	Current ECHA Candidate List: JUNE 2023 (235)
--	--



Candidate List Declared Against: JUNE 2023 (235)

Does not contain REACH SVHC

Halogen Content

Low Halogen - Br, Cl, F, I < 900 ppm per homogenous material. Also BFR/CFR/PVC Free

Solder Process Capability

Not applicable for solder process capability

Product Compliance Disclaimer

This information is provided based on reasonable inquiry of our suppliers and represents our current actual knowledge based on the information they provided. This information is subject to change. The part numbers that TE has identified as EU RoHS compliant have a maximum concentration of 0.1% by weight in homogenous materials for lead, hexavalent chromium, mercury, PBB, PBDE, DBP, BBP, DEHP, DIBP, and 0.01% for cadmium, or qualify for an exemption to these limits as defined in the Annexes of Directive 2011/65/EU (RoHS2). Finished electrical and electronic equipment products will be CE marked as required by Directive 2011/65/EU. Components may not be CE marked. Additionally, the part numbers that TE has identified as EU ELV compliant have a maximum concentration of 0.1% by weight in homogenous materials for lead, hexavalent chromium, and mercury, and 0.01% for cadmium, or qualify for an exemption to these limits as defined in the Annexes of Directive 2000/53/EC (ELV). Regarding the REACH Regulation, the information TE provides on SVHC in articles for this part number is based on the latest European Chemicals Agency (ECHA) 'Guidance on requirements for substances in articles' posted at this URL: <https://echa.europa.eu/guidance-documents/guidance-on-reach>

Compatible Parts



TE Part # 59170
T-HEAD PIDG SH 26-14 ASSY



TE Part # 58433-3
PRO CR ASSY, RBY IS9252



TE Part # 59250
T-HEAD PIDG 26-14 ASSY



TE Part # 47387
DAHT PG PIDG 20-14 ASSY



TE Part # 58423-1
DIE, RBY IS9252



TE Part # 47387-7
DAHT PG PIDG 16-12 ASSY



TE Part # 59824-1
TETRA-CRIMP PIDG PG FASTON 22-10 ASSY



TE Part # 525691
DAHT PG PIDG 16-14 ASSY

TE Part # 55823-1
RBY PRO CRIMPER KIT



TE Part # 47806-2
DIES PIDG 22-16 DIE SET

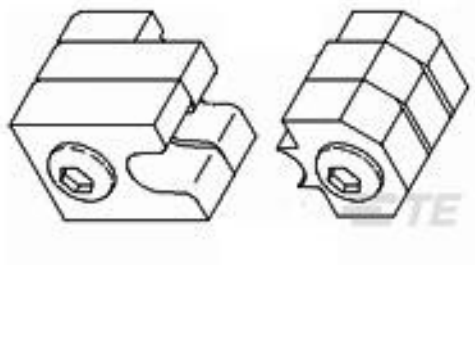

TE Part # 47807-1
DIES PIDG 16-14 DIE SET



TE Part # 1SET191002R0000
TET CRIMP-HT

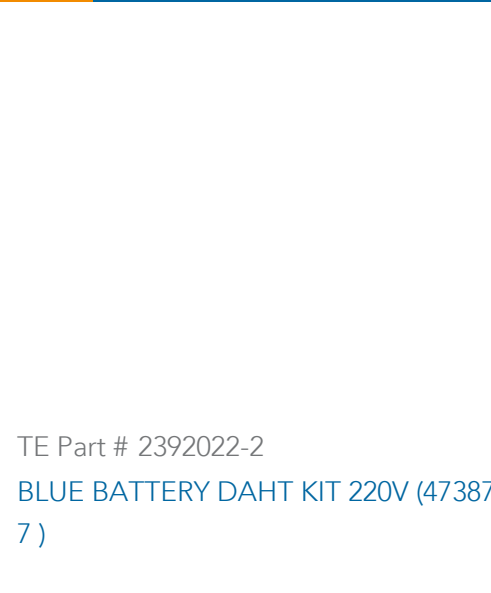

TE Part # 2392022-2
BLUE BATTERY DAHT KIT 220V (47387-7)

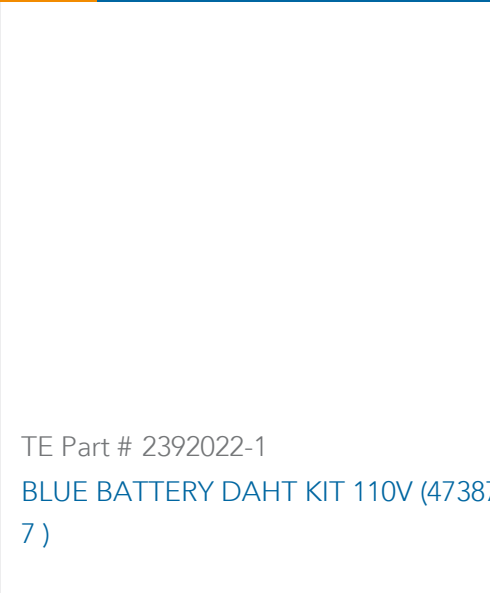

TE Part # 2392022-1
BLUE BATTERY DAHT KIT 110V (47387-7)



TE Part # 169404
CERTI-LOK DIE

Also in the Series | PIDG



Compression Connectors(17)



Crimp Terminal Housings(1)



Crimp Wire Pins, Tabs & Ferrules(40)



Hand Crimping Tools(2)



Knife Disconnects(11)



PCB Terminals(9)

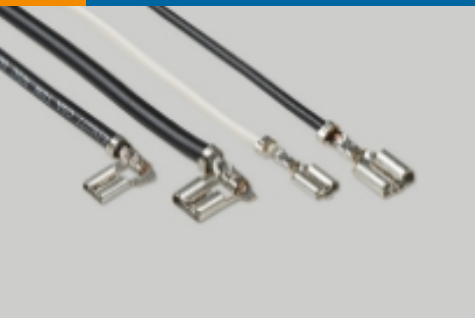

Quick Disconnects(49)



Ring Terminals & Spade Terminals(861)



Special Purpose Terminals(1)



Splices(47)

Customers Also Bought



TE Part #3-640470-4
04P MTA100 CONN ASSY ON TAPE



TE Part #6-1879494-7
CRGH0603 5% 560R 0.2W

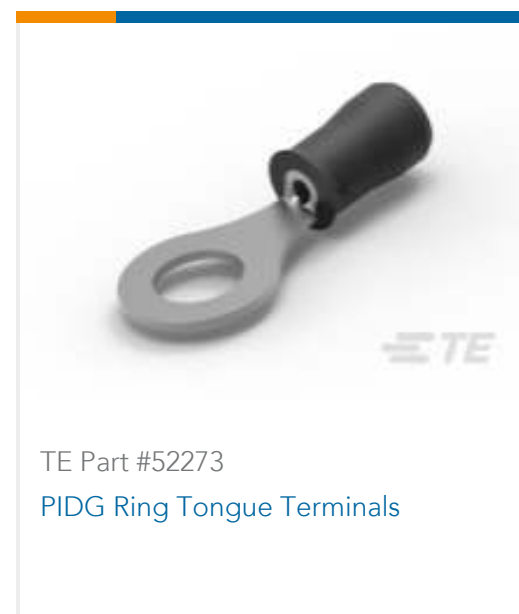

TE Part #52273
PIDG Ring Tongue Terminals



TE Part #E56137-000
SP100143WE5



TE Part #1333225-9
ANVIL, COMBINATION SPECIAL



TE Part #568176-6
CRIMPER, WIRE (.048" 'F')



TE Part #1-2119582-9
Crimper, Insulation F Premium

Documents

Product Drawings

[TERMINAL,PIDG R IR 14 6](#)

English

CAD Files

[3D PDF](#)

3D

Customer View Model

[ENG_CVM_CVM_51864-8_AF.2d_dxf.zip](#)

English

Customer View Model

[ENG_CVM_CVM_51864-8_AF.3d_igs.zip](#)

English

Customer View Model

[ENG_CVM_CVM_51864-8_AF.3d_stp.zip](#)

English

By downloading the CAD file I accept and agree to the [Terms and Conditions](#) of use.

Product Specifications

[Application Specification](#)

English

Product Environmental Compliance

[TE Material Declaration](#)

English

Agency Approvals

[CSA Certificate](#)



English