

**Customer Part:**

**Description**

- 0.9V low voltage oscillator in a hermetically sealed 3.2 x 2.5mm surface mount ceramic package.
- Model IQXO-691 3225-09
- Model Issue number 2

**Frequency Parameters**

- Frequency 26.0MHz
- Frequency Stability  $\pm 50.00\text{ppm}$
- Operating Temperature Range  $-40.00$  to  $85.00^\circ\text{C}$
- Ageing  $\pm 3\text{ppm}$  max in 1st year @  $25^\circ\text{C}$

**Electrical Parameters**

- Supply Voltage  $0.9\text{V} \pm 5\%$
- Current Draw  $10.000\text{mA}$

**Output Details**

- Output Compatibility CMOS
- Drive Capability  $15\text{pF}$  max
- Rise and Fall Time  $5.0\text{ns}$  max
- Duty Cycle 45/55%
- Output Voltage Levels:  
Output Low (VoL):  $10\%V_s$  max  
Output High (VoH):  $90\%V_s$  min
- Start Up Time:  $10\text{ms}$  max

**Output Control**

- Standby Operation:  
Logic '1' ( $\geq 70\% V_s$ ) to pad 1 enables oscillator output.  
Logic '0' ( $\leq 30\% V_s$ ) to pad 1 disables oscillator output; when disabled the oscillator output goes to the high impedance state.  
No connection to pad 1 enables oscillator output (internal pull-up resistor).
- Standby Current:  $100\mu\text{A}$  max

**Noise Parameters**

- RMS Phase Jitter (12kHz to 20MHz):  $1\text{ps}$  max

**Environmental Parameters**

- Storage Temperature Range:  $-55$  to  $125^\circ\text{C}$
- Mechanical Shock: MIL-STD-883, Method 2002, Condition B.
- Vibration: MIL-STD-883, Method 2007, Condition A.
- Moisture Resistance: MIL-STD-883, Method 1004.
- Thermal Cycling: MIL-STD-883, Method 1010, Condition B.
- Solderability: MIL-STD-883, Method 2003.
- Resistance to Soldering Heat: MIL-STD-202, Method 210, Condition K.
- Fine Leak Test: MIL-STD-883, Method 1014, Condition A.
- Gross Leak Test: MIL-STD-883, Method 1014, Condition C.

**Manufacturing Details**

- Note: Please connect a bypass capacitor of  $0.1\mu\text{F}$  between +Vs and circuit ground.
- RoHS Terminations Au
- RoHS Reflow Temp  $260^\circ\text{C}$  max for 10secs max

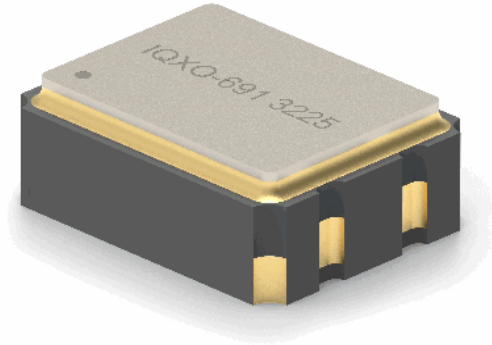
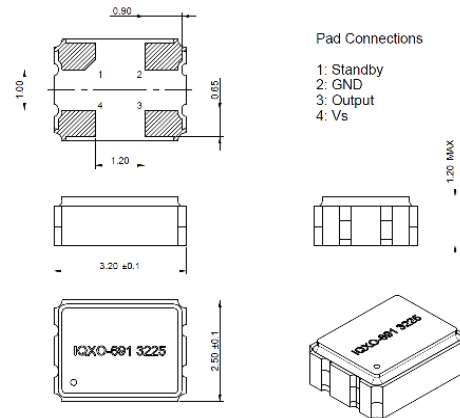
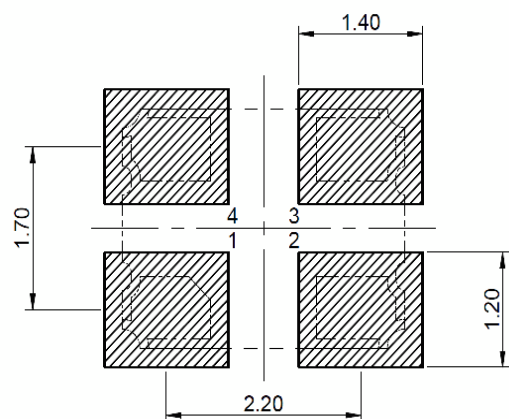
**Outline (mm)**

**Recommended Solder Pad Layout**

**Sales Office Contact Details:**

UK: +44 (0)1460 270200  
Germany: 0800 1808 443

France: 0800 901 383  
USA: +1.760.318.2824

Email: [info@iqdfrequencyproducts.com](mailto:info@iqdfrequencyproducts.com)  
Web: [www.iqdfrequencyproducts.com](http://www.iqdfrequencyproducts.com)



**Customer Part:**

**Compliance**

- RoHS Status (2015/863/EU)      Compliant
- REACH Status                      Compliant
- MSL Rating (JDEC-STD-033):    1

**Packaging Details**

- Pack Style: Reel      Tape & reel in accordance with EIA-481D  
Pack Size: 3,000
- *Alternative packing option available*

---

**Sales Office Contact Details:**

UK: +44 (0)1460 270200  
Germany: 0800 1808 443

France: 0800 901 383  
USA: +1.760.318.2824

Email: [info@iqdfrequencyproducts.com](mailto:info@iqdfrequencyproducts.com)  
Web: [www.iqdfrequencyproducts.com](http://www.iqdfrequencyproducts.com)