

## Features

- Low Loss
- Low Ripple
- Small Size

## Description

Surface mount, silver (Ag) coated ceramic filter for use in broadband applications.

Weight: 1.6 grams typical

Material: Filter is composed of a ceramic block plated with Ag

Filter complies with RoHS standards.

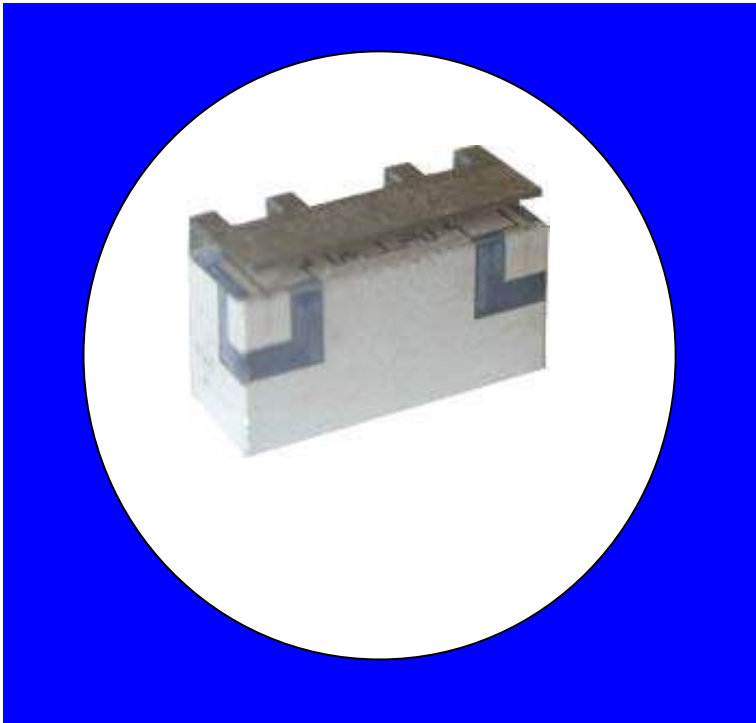

## Electrical Specifications

Parameter	Frequency MHz	Typical @ 25°C	Specification @ 25°C	Spec over -40°C to +85°C
Passband Iloss	698 - 746	-1.5	-1.8	-2.0
Passband Ripple	698 - 746	0.8	1.3	1.5
Passband Return Loss @ Port 1	698 - 746	-12.5	-11.0	-11.0
Passband Return Loss @ Port 2	698 - 746	-12.5	-11.0	-11.0
Attenuation	560 - 668	-18.9	-15.0	-15.0
	824 - 849	-30.7	-25.0	-25.0
	849 - 970	-39.2	-35.0	-35.0
Power into any port		4 Watt max		

Note: Supplier shall test each filter to the critical electrical specifications of the above table. Any subsequent audits may deviate from in value due to measurement repeatability among different test systems. Such deviations shall not exceed the following limits:

Specification Allowance	
Insertion Loss	0.1 dB
Return Loss	1.0 dB
Stopbands	1.0 dB

\*This product is covered by one or more of the following U.S. and foreign patents including: US 4,692,726;US 4,742,562; US 4,800,348;US 4,829,274;US 5,146,193;EP 0573597;DE 0573597;FR 0573597;JP 508149/92;KR 142171;US 5,162,760;US 5,218,329;US 5,250,916;US 5,327,109;US 5,488,335;CA 2114029;FR 9306297;GB 2273393;JP 3205337;KR 115113;CN 93106228.4;US 5,512,866;EP 0706719;DE 0706719;FR 0706719;GB 0706719;CN 95190359.4;US 5,602,518;US 5,721,520;US 5,745,018;EP 0910875;DE 0910875;DK 0910875;FR 0910875;GB 0910875;IE 0910875;JP 505182/98;KR 10-323013;US 5,994,978;US 6,462,629;CN 00810420.4;US 6,559,735;US 6,650,202;US 6,834,429. Other US and foreign patents pending.

\*CTS Corporation 2006 reserves all copyrights in the layout, design and configuration of the patterns on this product.\*

### Mechanical Drawing

Revision B - Origin Date: February 17, 2010 – Revision Date: July 11, 2011

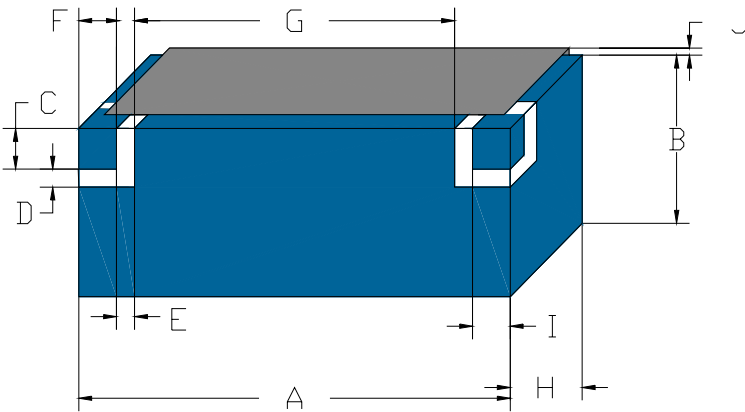

Dim	Nominal (mm)	Tolerance (mm) +/- or max
A	9.91	max
B	9.78	max
C	1.53	0.13
D	0.95	0.13
E	0.95	0.13
F	1.53	0.13
G	4.94	0.13
H	4.00	max
I	1.53	0.13
J	1.46	0.13

### Electrical response

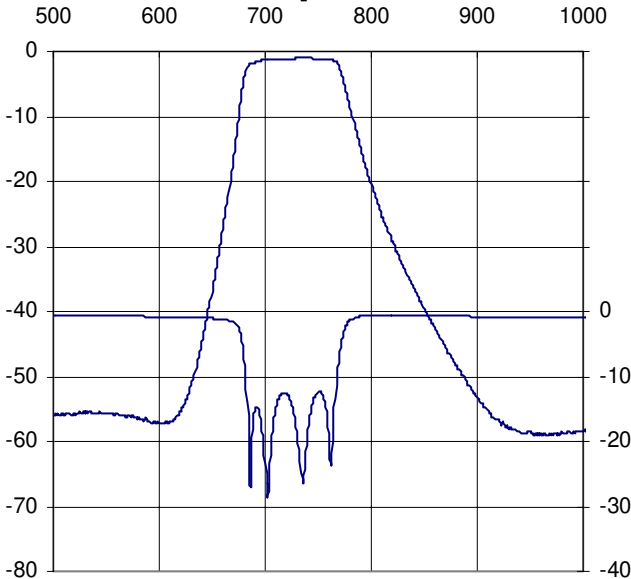

### PCB Layout

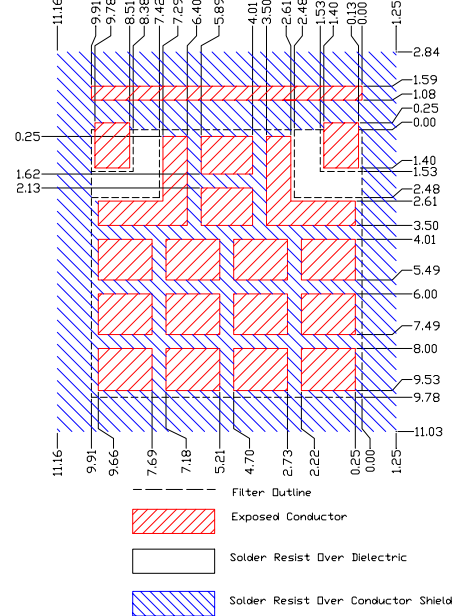

### Packaging and Marking

DIMENSION	UNITS	SPECIFICATION
REEL DIAMETER	mm	330
REEL WEIGHT	kg	1.6
REEL QUANTITY	ea.	1000

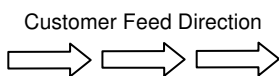

#### Product Marking

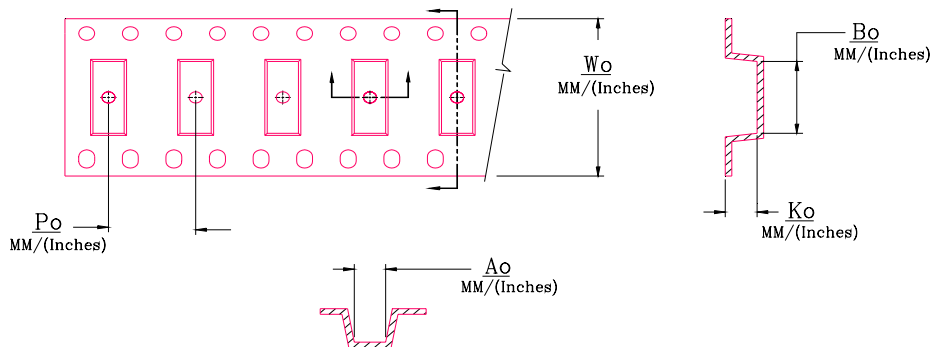
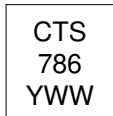

Wo	Ao	Bo	Ko	Po
Inches/mm	Inches/mm	Inches/mm	Inches/mm	Inches/mm
0.945" / 24.0	0.449" / 11.4	0.402" / 10.2	0.169" / 4.3	0.630" / 16.0