

RECOMMENDED PCB(CONNECTOR SIDE VIEW)
THICKNESS=1.6 TO 2.4 MM

| | | | | | |
|--------------------|---|--|--|-----------------------------|--------------------------|
| FUNCTIONAL SYMBOLS | THIS DRAWING CONTAINS INFORMATION THAT IS PROPRIETARY TO MOLEX ELECTRONIC TECHNOLOGIES, LLC AND SHOULD NOT BE USED WITHOUT WRITTEN PERMISSION | | CURRENT REV DESC: | | molex |
| | $\nabla_A = 0$ $\nabla_F = 0$ $\nabla_V = 0$ | DIMENSION UNITS: mm SCALE: 5:1 | EC NO: 697101 DRWN: GLLI CHK'D: XQZHANG APPR: XQZHANG | | |
| DIVISIONAL SYMBOLS | GENERAL TOLERANCES (UNLESS SPECIFIED) | | INITIAL REVISION: | | PRODUCT CUSTOMER DRAWING |
| | ANGULAR TOL ± 3.0° | | DRWN: GLLI | | DOCUMENT NUMBER |
| | 4 PLACES ± | | APPR: YXZHENG | | DOC TYPE |
| | 3 PLACES ± 0.1 | | 2019/09/24 | | DOC PART |
| 2 PLACES ± 0.2 | | 2020/03/16 | | REVISION | |
| 1 PLACE ± 0.3 | | DRAFT WHERE APPLICABLE MUST REMAIN WITHIN DIMENSIONS | | 1053121000-SD PSD 000 B1 | |
| 0 PLACES ± | | THIRD ANGLE PROJECTION | DRAWING | SERIES | MATERIAL NUMBER |
| | | | A3-SIZE | 105312 | CUSTOMER |
| | | | | | GENERAL MARKET |
| | | | | | SHEET NUMBER |
| | | | | | 1 OF 5 |

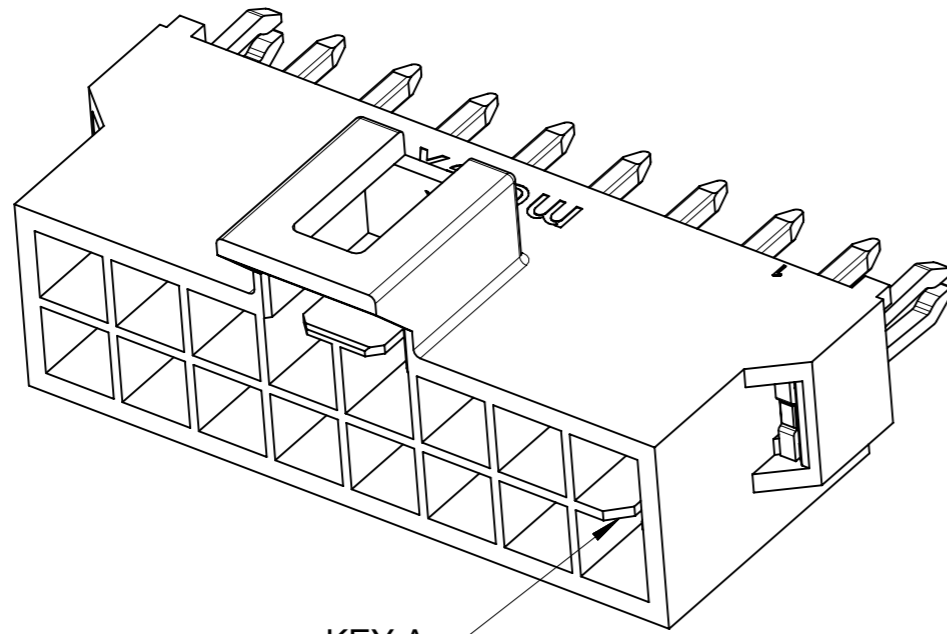

KEY A

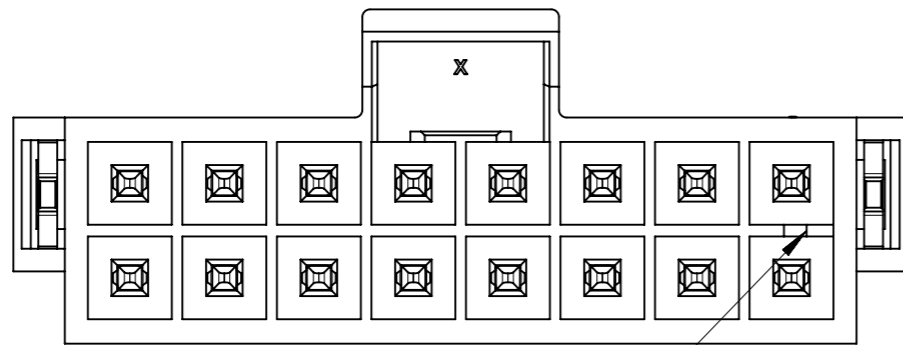

KEY A

BLACK

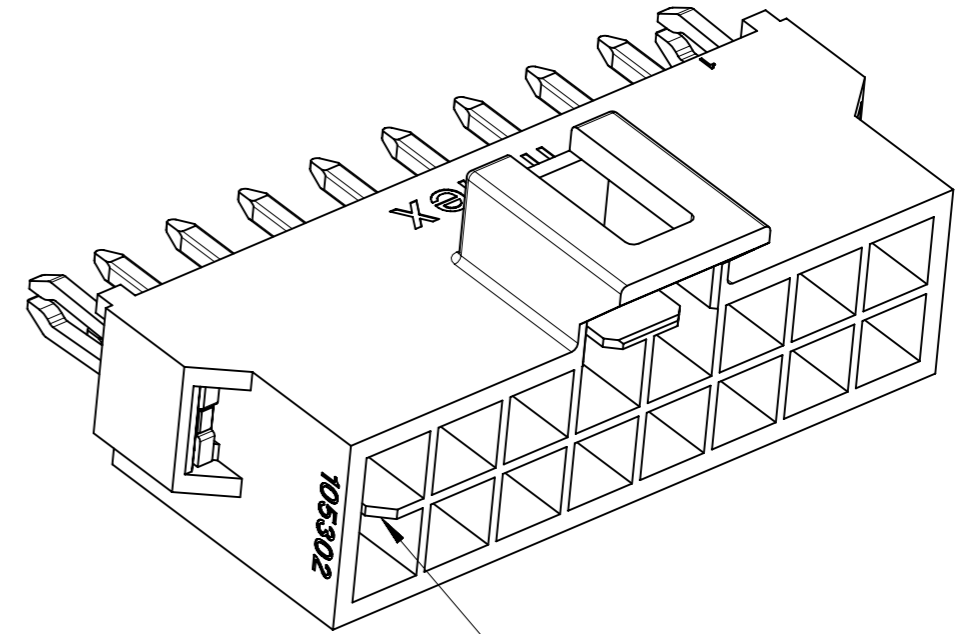

KEY B

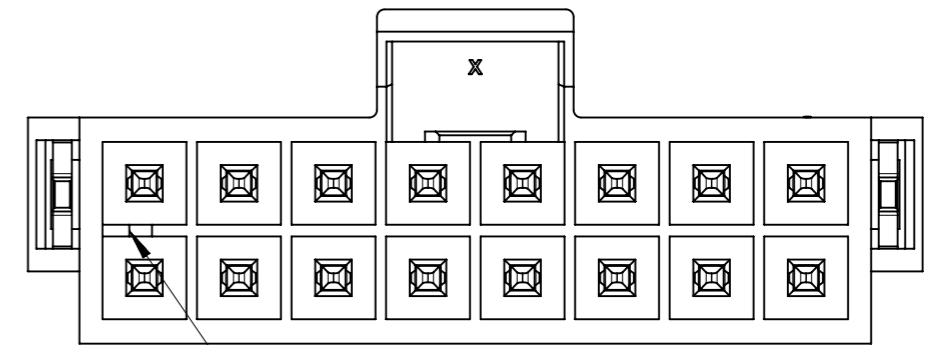

KEY B

NATURAL

COLOR OPTION

| | | | | | | | | | |
|--------------------|---|----|---|---------|---|-----------------|----------|-----------|----------|
| FUNCTIONAL SYMBOLS | THIS DRAWING CONTAINS INFORMATION THAT IS PROPRIETARY TO MOLEX ELECTRONIC TECHNOLOGIES, LLC AND SHOULD NOT BE USED WITHOUT WRITTEN PERMISSION | | CURRENT REV DESC: | | molex | | | | |
| | ▽A = 0 | mm | | | | | | SCALE 5:1 | |
| ▽E = 0 | GENERAL TOLERANCES (UNLESS SPECIFIED) | | EC NO: 697101 DRWN: GLLI 2022/02/24 CHK'D: XQZHANG 2022/02/25 APPR: XQZHANG 2022/02/25 INITIAL REVISION: DRWN: GLLI 2019/09/24 APPR: YXZHENG 2020/03/16 | | HEADER OF NANO-FIT, D/R, CLIP, VERTICAL POWER CONNECTOR | | | | |
| ▽V = 0 | ANGULAR TOL ± 3.0° | | | | PRODUCT CUSTOMER DRAWING | | | | |
| DIVISIONAL SYMBOLS | 4 PLACES | ± | | | | DOCUMENT NUMBER | DOC TYPE | DOC PART | REVISION |
| | 3 PLACES | ± | | | 0.1 | 1053121000-SD | PSD | 000 | B1 |
| | 2 PLACES | ± | | | 0.2 | MATERIAL NUMBER | | CUSTOMER | |
| | 1 PLACE | ± | 0.3 | 105312 | | GENERAL MARKET | | | |
| | 0 PLACES | ± | | SERIES | | SHEET NUMBER | | | |
| | DRAFT WHERE APPLICABLE MUST REMAIN WITHIN DIMENSIONS | | THIRD ANGLE PROJECTION | DRAWING | A3-SIZE | | 2 OF 5 | | |

| | | | | |
|-----------------|----|--------------|------------|----------|
| DOCUMENT STATUS | P1 | RELEASE DATE | 2022/02/25 | 03:08:44 |
|-----------------|----|--------------|------------|----------|

| PART NUMBER | DIM 'A' | DIM 'B' | DIM 'C' | CKT SIZE | PLATING | MYLAR |
|-------------|---------|---------|---------|----------|-----------|---------------------|
| 105312-3504 | 8.66 | 5.94 | 6.84 | 4 | TIN | YES |
| 105312-3506 | 11.16 | 8.44 | 9.34 | 6 | | |
| 105312-3508 | 13.66 | 10.94 | 11.84 | 8 | | |
| 105312-3510 | 16.16 | 13.44 | 14.34 | 10 | | |
| 105312-3512 | 18.66 | 15.94 | 16.84 | 12 | | |
| 105312-3514 | 21.16 | 18.44 | 19.34 | 14 | | |
| 105312-3516 | 23.66 | 20.94 | 21.84 | 16 | | |
| 105312-3704 | 8.66 | 5.94 | 6.84 | 4 | | |
| 105312-3706 | 11.16 | 8.44 | 9.34 | 6 | | |
| 105312-3708 | 13.66 | 10.94 | 11.84 | 8 | | |
| 105312-3710 | 16.16 | 13.44 | 14.34 | 10 | | |
| 105312-3712 | 18.66 | 15.94 | 16.84 | 12 | | |
| 105312-3714 | 21.16 | 18.44 | 19.34 | 14 | | |
| 105312-3716 | 23.66 | 20.94 | 21.84 | 16 | | |
| 105312-3604 | 8.66 | 5.94 | 6.84 | 4 | GOLD 0.76 | |
| 105312-3606 | 11.16 | 8.44 | 9.34 | 6 | | |
| 105312-3608 | 13.66 | 10.94 | 11.84 | 8 | | |
| 105312-3610 | 16.16 | 13.44 | 14.34 | 10 | | |
| 105312-3612 | 18.66 | 15.94 | 16.84 | 12 | | |
| 105312-3614 | 21.16 | 18.44 | 19.34 | 14 | | |
| 105312-3616 | 23.66 | 20.94 | 21.84 | 16 | | |
| 105312-3804 | 8.66 | 5.94 | 6.84 | 4 | | GOLD 0.76 + LUBE |
| 105312-3806 | 11.16 | 8.44 | 9.34 | 6 | | |
| 105312-3808 | 13.66 | 10.94 | 11.84 | 8 | | |
| 105312-3810 | 16.16 | 13.44 | 14.34 | 10 | | |
| 105312-3812 | 18.66 | 15.94 | 16.84 | 12 | | |
| 105312-3814 | 21.16 | 18.44 | 19.34 | 14 | | |
| 105312-3816 | 23.66 | 20.94 | 21.84 | 16 | | |

COLOR: BLACK

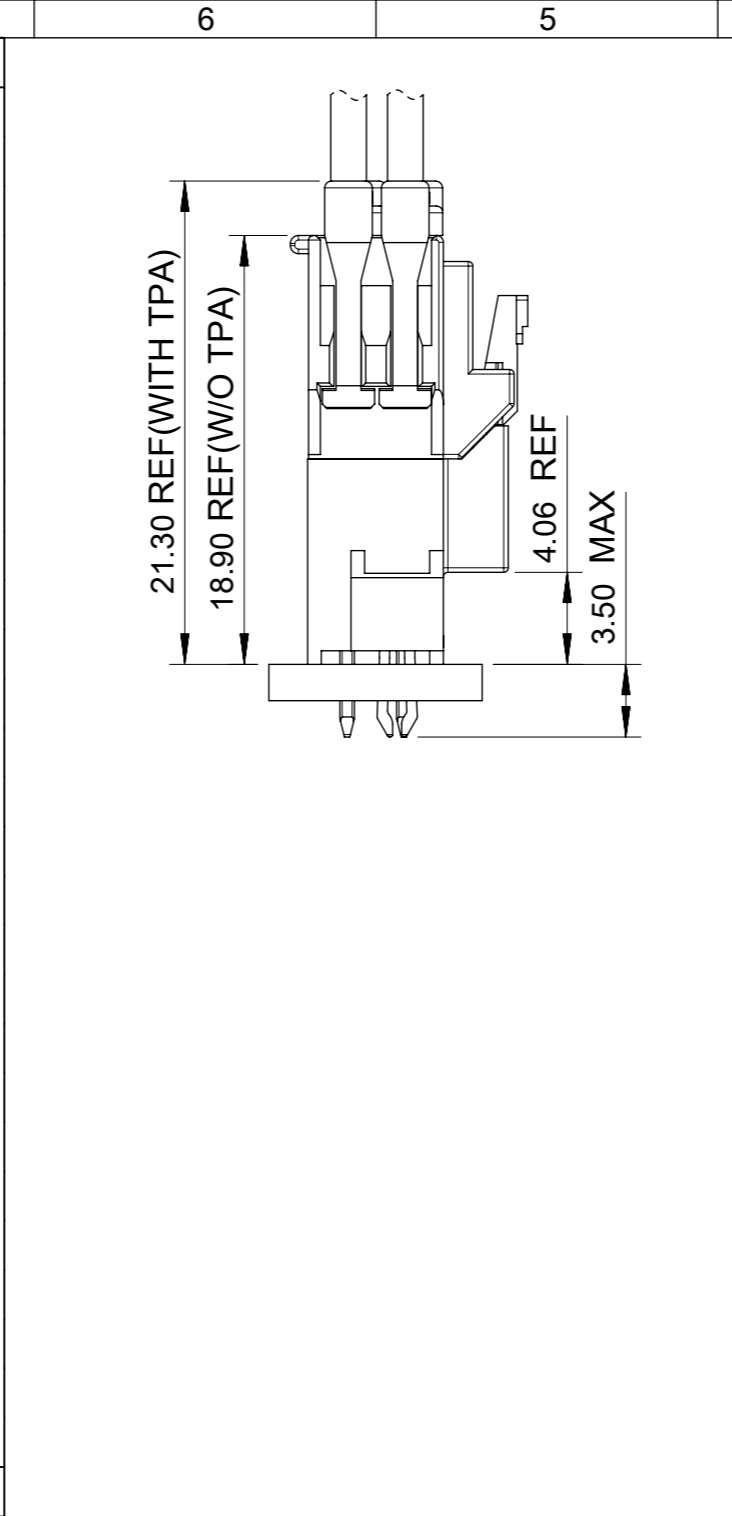

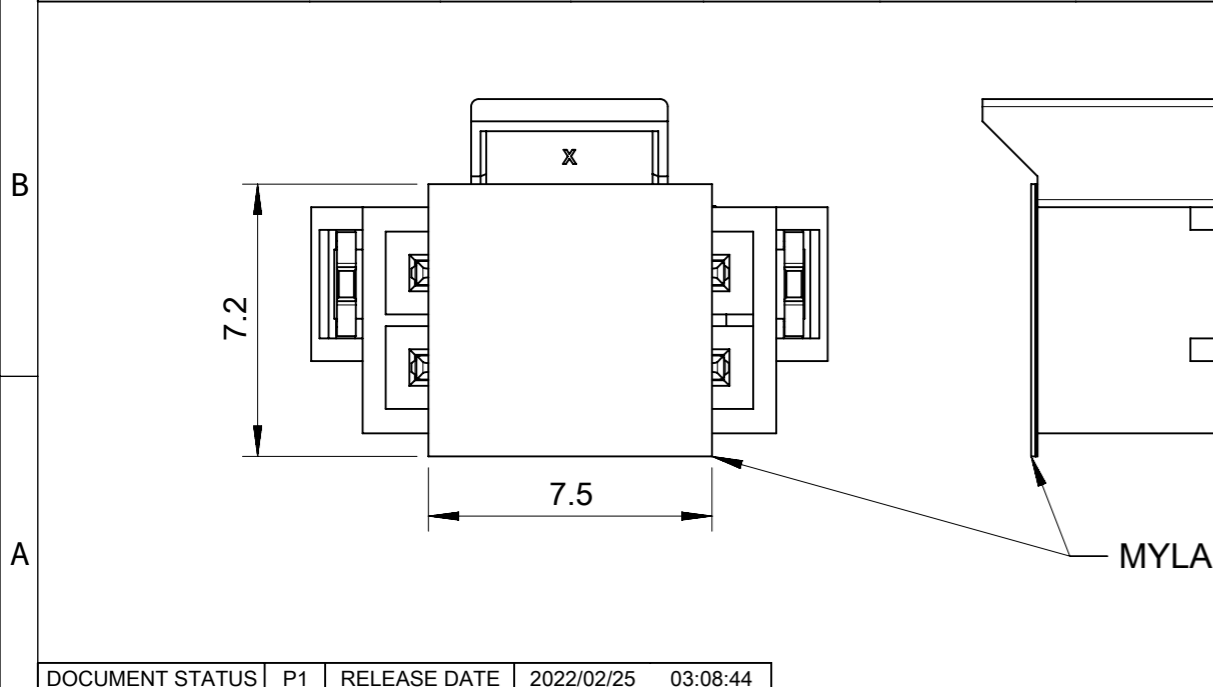

| PART NUMBER | DIM 'A' | DIM 'B' | DIM 'C' | CKT SIZE | PLATING | MYLAR |
|-------------|---------|---------|---------|----------|-----------|---------------------|
| 105312-4504 | 8.66 | 5.94 | 6.84 | 4 | TIN | YES |
| 105312-4506 | 11.16 | 8.44 | 9.34 | 6 | | |
| 105312-4508 | 13.66 | 10.94 | 11.84 | 8 | | |
| 105312-4510 | 16.16 | 13.44 | 14.34 | 10 | | |
| 105312-4512 | 18.66 | 15.94 | 16.84 | 12 | | |
| 105312-4514 | 21.16 | 18.44 | 19.34 | 14 | | |
| 105312-4516 | 23.66 | 20.94 | 21.84 | 16 | | |
| 105312-4704 | 8.66 | 5.94 | 6.84 | 4 | | |
| 105312-4706 | 11.16 | 8.44 | 9.34 | 6 | | |
| 105312-4708 | 13.66 | 10.94 | 11.84 | 8 | | |
| 105312-4710 | 16.16 | 13.44 | 14.34 | 10 | | |
| 105312-4712 | 18.66 | 15.94 | 16.84 | 12 | | |
| 105312-4714 | 21.16 | 18.44 | 19.34 | 14 | | |
| 105312-4716 | 23.66 | 20.94 | 21.84 | 16 | | |
| 105312-4604 | 8.66 | 5.94 | 6.84 | 4 | GOLD 0.76 | |
| 105312-4606 | 11.16 | 8.44 | 9.34 | 6 | | |
| 105312-4608 | 13.66 | 10.94 | 11.84 | 8 | | |
| 105312-4610 | 16.16 | 13.44 | 14.34 | 10 | | |
| 105312-4612 | 18.66 | 15.94 | 16.84 | 12 | | |
| 105312-4614 | 21.16 | 18.44 | 19.34 | 14 | | |
| 105312-4616 | 23.66 | 20.94 | 21.84 | 16 | | |
| 105312-4804 | 8.66 | 5.94 | 6.84 | 4 | | GOLD 0.76 + LUBE |
| 105312-4806 | 11.16 | 8.44 | 9.34 | 6 | | |
| 105312-4808 | 13.66 | 10.94 | 11.84 | 8 | | |
| 105312-4810 | 16.16 | 13.44 | 14.34 | 10 | | |
| 105312-4812 | 18.66 | 15.94 | 16.84 | 12 | | |
| 105312-4814 | 21.16 | 18.44 | 19.34 | 14 | | |
| 105312-4816 | 23.66 | 20.94 | 21.84 | 16 | | |

COLOR: NATURAL

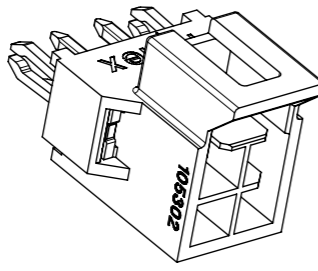
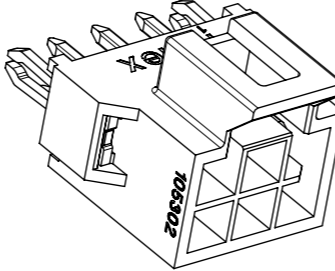
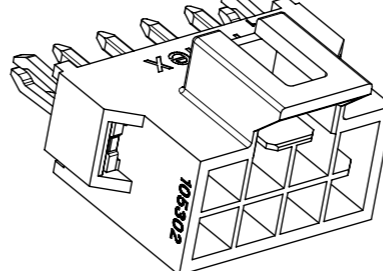
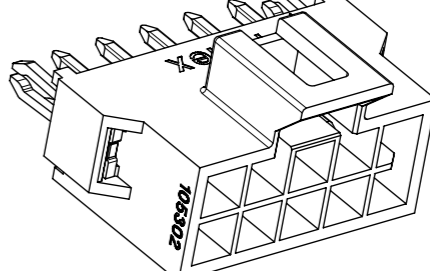
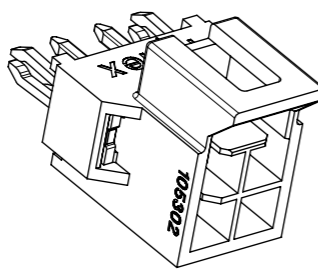
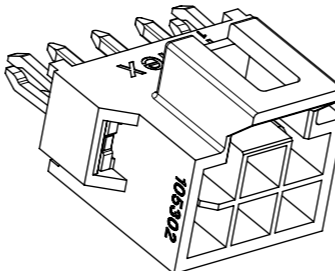
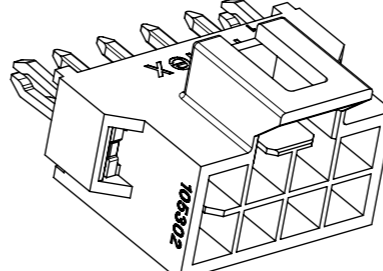
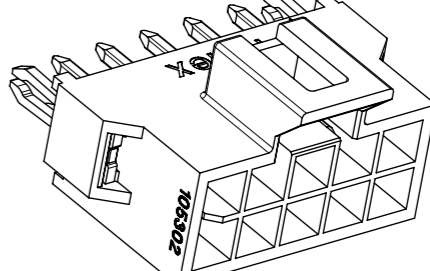
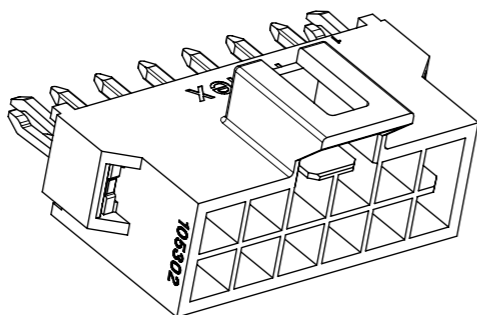
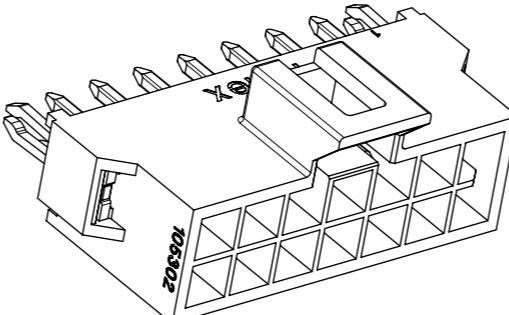
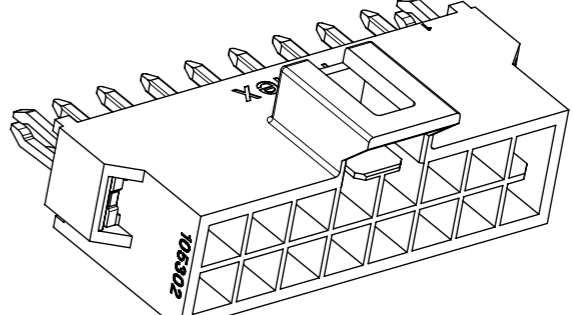
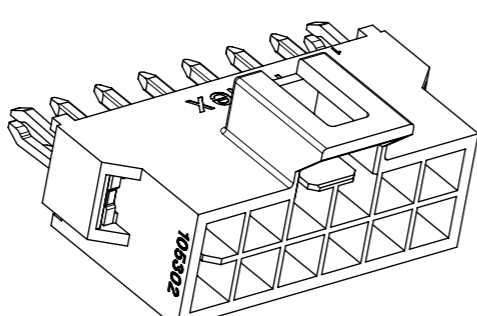
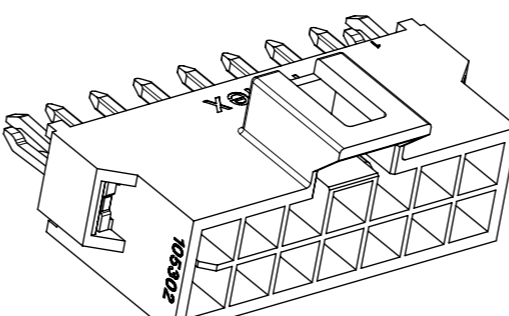
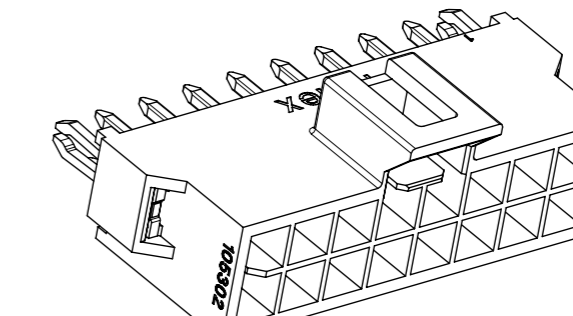

| | | | | | | | | | | | | | | | | | | | | | | | | | | | | | | | | | | | | | | | | | | | | | | | |
|--|---|--|-----------------|-----------------|-----------------|----------------|--------------|-----|---------------------------------------|---------|--------|----------------|-----------------------------|--------|---|-----------------|----|--------------------|--------------------|--|--------------------|-------------------|----------------|---|------------|------------|------------|------------|------------|--|--|---|--|--|--------------------------|--|--|-----------------|----------|----------|---------------|-----|-----|----------|--------------|--|----|
| FUNCTIONAL SYMBOLS | THIS DRAWING CONTAINS INFORMATION THAT IS PROPRIETARY TO MOLEX ELECTRONIC TECHNOLOGIES, LLC AND SHOULD NOT BE USED WITHOUT WRITTEN PERMISSION | CURRENT REV DESC: | | molex | | | | | | | | | | | | | | | | | | | | | | | | | | | | | | | | | | | | | | | | | | | |
| | <table border="1"> <tr><td>FUNCTIONAL SYMBOLS</td><td>DIMENSION UNITS</td><td>SCALE</td></tr> <tr><td>$\nabla_A = 0$</td><td>mm</td><td>5:1</td></tr> <tr><td colspan="3">GENERAL TOLERANCES (UNLESS SPECIFIED)</td></tr> <tr><td>$\nabla_E = 0$</td><td colspan="2">ANGULAR TOL $\pm 3.0^\circ$</td></tr> <tr><td>$\nabla_F = 0$</td><td colspan="2">4 PLACES \pm</td></tr> <tr><td rowspan="4">DIVISIONAL SYMBOLS</td><td>3 PLACES ± 0.1</td><td rowspan="4">EC NO: 697101 DRWN: GLLI CHK'D: XQZHANG APPR: XQZHANG INITIAL REVISION: DRWN: GLLI APPR: YXZHENG</td></tr> <tr><td>2 PLACES ± 0.2</td></tr> <tr><td>1 PLACE ± 0.3</td></tr> <tr><td>0 PLACES \pm</td></tr> </table> | FUNCTIONAL SYMBOLS | DIMENSION UNITS | | SCALE | $\nabla_A = 0$ | mm | 5:1 | GENERAL TOLERANCES (UNLESS SPECIFIED) | | | $\nabla_E = 0$ | ANGULAR TOL $\pm 3.0^\circ$ | | $\nabla_F = 0$ | 4 PLACES \pm | | DIVISIONAL SYMBOLS | 3 PLACES ± 0.1 | EC NO: 697101 DRWN: GLLI CHK'D: XQZHANG APPR: XQZHANG INITIAL REVISION: DRWN: GLLI APPR: YXZHENG | 2 PLACES ± 0.2 | 1 PLACE ± 0.3 | 0 PLACES \pm | <table border="1"> <tr><td>2022/02/24</td><td>2022/02/25</td><td>2022/02/25</td></tr> <tr><td>2019/09/24</td><td>2020/03/16</td><td></td></tr> </table> | 2022/02/24 | 2022/02/25 | 2022/02/25 | 2019/09/24 | 2020/03/16 | | <table border="1"> <tr><td colspan="3">HEADER OF NANO-FIT, D/R, CLIP, VERTICAL POWER CONNECTOR</td></tr> <tr><td colspan="3">PRODUCT CUSTOMER DRAWING</td></tr> <tr><td>DOCUMENT NUMBER</td><td>DOC TYPE</td><td>DOC PART</td></tr> <tr><td>1053121000-SD</td><td>PSD</td><td>000</td></tr> <tr><td>REVISION</td><td colspan="2">SHEET NUMBER</td></tr> <tr><td>B1</td><td colspan="2">3 OF 5</td></tr> </table> | HEADER OF NANO-FIT, D/R, CLIP, VERTICAL POWER CONNECTOR | | | PRODUCT CUSTOMER DRAWING | | | DOCUMENT NUMBER | DOC TYPE | DOC PART | 1053121000-SD | PSD | 000 | REVISION | SHEET NUMBER | | B1 |
| FUNCTIONAL SYMBOLS | DIMENSION UNITS | SCALE | | | | | | | | | | | | | | | | | | | | | | | | | | | | | | | | | | | | | | | | | | | | | |
| $\nabla_A = 0$ | mm | 5:1 | | | | | | | | | | | | | | | | | | | | | | | | | | | | | | | | | | | | | | | | | | | | | |
| GENERAL TOLERANCES (UNLESS SPECIFIED) | | | | | | | | | | | | | | | | | | | | | | | | | | | | | | | | | | | | | | | | | | | | | | | |
| $\nabla_E = 0$ | ANGULAR TOL $\pm 3.0^\circ$ | | | | | | | | | | | | | | | | | | | | | | | | | | | | | | | | | | | | | | | | | | | | | | |
| $\nabla_F = 0$ | 4 PLACES \pm | | | | | | | | | | | | | | | | | | | | | | | | | | | | | | | | | | | | | | | | | | | | | | |
| DIVISIONAL SYMBOLS | 3 PLACES ± 0.1 | EC NO: 697101 DRWN: GLLI CHK'D: XQZHANG APPR: XQZHANG INITIAL REVISION: DRWN: GLLI APPR: YXZHENG | | | | | | | | | | | | | | | | | | | | | | | | | | | | | | | | | | | | | | | | | | | | | |
| | 2 PLACES ± 0.2 | | | | | | | | | | | | | | | | | | | | | | | | | | | | | | | | | | | | | | | | | | | | | | |
| | 1 PLACE ± 0.3 | | | | | | | | | | | | | | | | | | | | | | | | | | | | | | | | | | | | | | | | | | | | | | |
| | 0 PLACES \pm | | | | | | | | | | | | | | | | | | | | | | | | | | | | | | | | | | | | | | | | | | | | | | |
| 2022/02/24 | 2022/02/25 | 2022/02/25 | | | | | | | | | | | | | | | | | | | | | | | | | | | | | | | | | | | | | | | | | | | | | |
| 2019/09/24 | 2020/03/16 | | | | | | | | | | | | | | | | | | | | | | | | | | | | | | | | | | | | | | | | | | | | | | |
| HEADER OF NANO-FIT, D/R, CLIP, VERTICAL POWER CONNECTOR | | | | | | | | | | | | | | | | | | | | | | | | | | | | | | | | | | | | | | | | | | | | | | | |
| PRODUCT CUSTOMER DRAWING | | | | | | | | | | | | | | | | | | | | | | | | | | | | | | | | | | | | | | | | | | | | | | | |
| DOCUMENT NUMBER | DOC TYPE | DOC PART | | | | | | | | | | | | | | | | | | | | | | | | | | | | | | | | | | | | | | | | | | | | | |
| 1053121000-SD | PSD | 000 | | | | | | | | | | | | | | | | | | | | | | | | | | | | | | | | | | | | | | | | | | | | | |
| REVISION | SHEET NUMBER | | | | | | | | | | | | | | | | | | | | | | | | | | | | | | | | | | | | | | | | | | | | | | |
| B1 | 3 OF 5 | | | | | | | | | | | | | | | | | | | | | | | | | | | | | | | | | | | | | | | | | | | | | | |
| <table border="1"> <tr><td>DRAFT WHERE APPLICABLE MUST REMAIN WITHIN DIMENSIONS</td><td>THIRD ANGLE PROJECTION</td><td>DRAWING</td><td>SERIES</td><td>MATERIAL NUMBER</td><td>CUSTOMER</td><td>SHEET NUMBER</td></tr> <tr><td></td><td></td><td>A3-SIZE</td><td>105312</td><td></td><td>GENERAL MARKET</td><td>3 OF 5</td></tr> </table> | DRAFT WHERE APPLICABLE MUST REMAIN WITHIN DIMENSIONS | THIRD ANGLE PROJECTION | DRAWING | SERIES | MATERIAL NUMBER | CUSTOMER | SHEET NUMBER | | | A3-SIZE | 105312 | | GENERAL MARKET | 3 OF 5 | <table border="1"> <tr><td>DOCUMENT STATUS</td><td>P1</td><td>RELEASE DATE</td><td>2022/02/25</td><td>03:08:44</td></tr> </table> | DOCUMENT STATUS | P1 | RELEASE DATE | 2022/02/25 | 03:08:44 | | | | | | | | | | | | | | | | | | | | | | | | | | | |
| DRAFT WHERE APPLICABLE MUST REMAIN WITHIN DIMENSIONS | THIRD ANGLE PROJECTION | DRAWING | SERIES | MATERIAL NUMBER | CUSTOMER | SHEET NUMBER | | | | | | | | | | | | | | | | | | | | | | | | | | | | | | | | | | | | | | | | | |
| | | A3-SIZE | 105312 | | GENERAL MARKET | 3 OF 5 | | | | | | | | | | | | | | | | | | | | | | | | | | | | | | | | | | | | | | | | | |
| DOCUMENT STATUS | P1 | RELEASE DATE | 2022/02/25 | 03:08:44 | | | | | | | | | | | | | | | | | | | | | | | | | | | | | | | | | | | | | | | | | | | |

| | | | | | |
|---|---------|--|---|---|---|
| | | 4 CKT | 6 CKT | 8 CKT | 10 CKT |
| F | BLACK |  |  |  |  |
| E | NATURAL |  |  |  |  |
| | | 12 CKT | 14 CKT | 16 CKT | |
| D | BLACK |  |  |  | |
| C | NATURAL |  |  |  | |

| | | | | | | | | | | |
|--------------------|---|---|---------------------------------|---|-----------------------------|-----------------------|---------------------------------------|--|--|---|
| FUNCTIONAL SYMBOLS | THIS DRAWING CONTAINS INFORMATION THAT IS PROPRIETARY TO MOLEX ELECTRONIC TECHNOLOGIES, LLC AND SHOULD NOT BE USED WITHOUT WRITTEN PERMISSION | | CURRENT REV DESC: | | molex | | | | | |
| | $\nabla_A = 0$ $\nabla_E = 0$ $\nabla_V = 0$ | DIMENSION UNITS: mm SCALE: 3:1 GENERAL TOLERANCES (UNLESS SPECIFIED) ANGULAR TOL $\pm 3.0^\circ$ | | | | | | EC NO: 697101 DRWN: GLLI APPR: XQZHANG INITIAL REVISION: DRWN: GLLI APPR: YXZHENG | 2022/02/24 2022/02/25 2022/02/25 2019/09/24 2020/03/16 | HEADER OF NANO-FIT, D/R, CLIP, VERTICAL POWER CONNECTOR PRODUCT CUSTOMER DRAWING |
| DIVISIONAL SYMBOLS | 4 PLACES \pm 3 PLACES ± 0.1 2 PLACES ± 0.2 1 PLACE ± 0.3 0 PLACES \pm | DRAFT WHERE APPLICABLE MUST REMAIN WITHIN DIMENSIONS | | THIRD ANGLE PROJECTION  | DRAWING: A3-SIZE | SERIES: 105312 | DOCUMENT NUMBER: 1053121000-SD | DOC TYPE: PSD | DOC PART: 000 | REVISION: B1 |
| | MATERIAL NUMBER: 105312 | | CUSTOMER: GENERAL MARKET | | SHEET NUMBER: 4 OF 5 | | | | | |

NOTES FOR ALL PARTS

1> MATERIAL:
 HOUSING: LCP, UL 94V-0.
 TERMINAL: BRASS.
 SOLDER CLIP: BRASS.

2> PLATING FINISHED:
 TERMINAL:
 CONTACT AREA: a. REFLOW MATTE TIN 1.5MICRONS MIN;
 b. GOLD 0.38 MICRONS MIN;
 c. GOLD 0.76 MICRONS MIN.
 SOLDER AREA: MATTE TIN 1.5 MICRONS MIN, UNDER PLATING NICKEL 1.25 MICRONS MIN.
 SOLDER CLIP: MATTE TIN 2.5 MICRONS MIN, UNDER PLATING NICKEL 1.25 MICRONS MIN.

3> PRODUCT SPECIFICATION: PS-105300-100.
 4> PACKAGE: TAPE REEL, 1053121000-PK.
 5> PRODUCT MATE WITH SERIES OF 105308(RECEPTACLE), 105300(CRIMP TERMINAL).
 6> PARTS CONFORM TO CLASS 'B'REQUIREMENTS OF COSMETIC SPECIFICATION PS-45499-002.
 7> DISCOLORATION IN THE BANDOLIER PIN CARRIER AREA OF THE PIN IS INHERENT TO THE PLATING PROCESS AND IS DUE TO THE MASKING DEFECT OF THE CARRIER, THIS DISCOLORATION IS IN A NON-FUNCTION AREA OF THE PIN AND WILL NOT AFFECT THE PERFORMANCE OF THE HEADER ASSEMBLY.

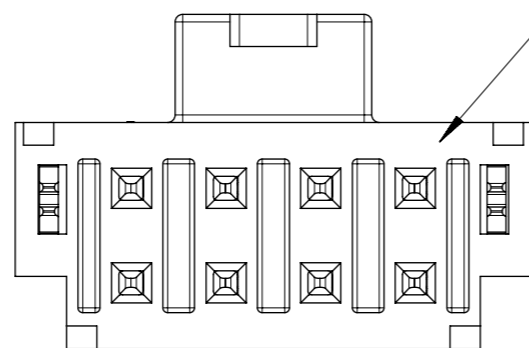

IF ANY NUMBER MARK APPEARS ON THIS SURFACE, PLEASE DISREGARD IT, IT IS NO ANY FUCTION AND NO ANY RELATION TO PIN NUMBER, IT IS JUST FOR MOLDING IDENDIFICATION.

| | | | | | | | | | |
|--|---|------------------------|--|--------|---|----------------|--------------|----------|----|
| FUNCTIONAL SYMBOLS | THIS DRAWING CONTAINS INFORMATION THAT IS PROPRIETARY TO MOLEX ELECTRONIC TECHNOLOGIES, LLC AND SHOULD NOT BE USED WITHOUT WRITTEN PERMISSION | | CURRENT REV DESC: | | molex | | | | |
| | mm | 1:1 | | | | | | | |
| DIVISIONAL SYMBOLS | GENERAL TOLERANCES (UNLESS SPECIFIED) | | EC NO: 697101 DRWN: GLLI CHK'D: XQZHANG APPR: XQZHANG INITIAL REVISION: DRWN: GLLI APPR: YXZHENG | | HEADER OF NANO-FIT, D/R, CLIP, VERTICAL POWER CONNECTOR | | | | |
| | ANGULAR TOL ± 3.0° | | | | PRODUCT CUSTOMER DRAWING | | | | |
| | 4 PLACES ± | | | | 2022/02/24 | DOC TYPE | DOC PART | REVISION | |
| | 3 PLACES ± 0.1 | | | | 2022/02/25 | 1053121000-SD | PSD | 000 | B1 |
| | 2 PLACES ± 0.2 | | | | 2022/02/25 | | | | |
| 1 PLACE ± 0.3 | | | | | | | | | |
| 0 PLACES ± | | | | | | | | | |
| DRAFT WHERE APPLICABLE MUST REMAIN WITHIN DIMENSIONS | | THIRD ANGLE PROJECTION | DRAWING | SERIES | MATERIAL NUMBER | CUSTOMER | SHEET NUMBER | | |
| | | | A3-SIZE | 105312 | | GENERAL MARKET | 5 OF 5 | | |