

|   |  |        |
|---|--|--------|
| GlobTek, Inc.<br>www.globtek.com<br>186 Veterans Drive,<br>Northvale, NJ 07647<br>Tel. (201) 784-1000<br>Fax (201) 784-0111 | Drawing Title: GTM96600-4005-T2A, ICT / ITE / Medical Power Supply/Class 2/Household Power Supply, Efficiency Level: USA DOE Level VI / Eco-design Directive 2009/125/EC, (EU) 2019/1782, Case Color/Style: GlobTek Black, Desktop/External, Regulated Switchmode AC-DC Power Supply AC Adaptor, Input Rating: 100-240V~, 50-60Hz, IEC 60320/C18 , Output Rating: 40W, 5.0V@8.0A, Output Configuration: 1200 mm, 14/1C + Shield Cond, UL 1185, Female Barrel 5.5 * 2.5 * 11mm with internal Spring Clip and Locking Notch or Equal, Ferrite: Core size: 17.5*28.5*12.5, GlobTek Black, GT Cord # C5137, Pin Out: Center Positive (+V), symbol compliant with IEC 60417 symbol no. 5926, Blades/Input Cord: Not Applicable, Approvals: CB 60335; Fuse 60335; 230V CoC Tier 2; CB 62368; South Africa; cETLus 60601-1; IP41; UKCA; UL 1310; NRCAN (5V only); Morocco; Korea (9-15V Only); ETL; RCM; IRAM; PSE; PSE; PSE; CE; China RoHS; Level VI; RoHS; Ukraine; VCCI; WEEE; ETL 60950; S-Mark 60950; CB 60950; Double Insulation; CB 60601-1; S-Mark IEC/EN 60601-1; EAC; LPS 60950; South Africa; |        |
|   | Model No. GTM96600-4005-T2A  |        |
|   | Part No./Ordering No. TR9WA8000LCPIM(R6B)  | Rev C1 |

In Addition to GlobTek Inc.'s renewed ISO9001:2015 - Quality Management System Certification, GlobTek Inc. is now certified to:

ISO13485:2016 - Medical Devices Quality Management System Certification

ISO14001:2015 - Environmental Management System Certification

ISO Certificates are available online at <https://www.globtek.com/iso-certificates/>

The acceptance of this specification and use of the product described in this document indicates the acceptance and binding of the customer to Globtek TERMS AND CONDITIONS (attached to the end of this document), which supersede all other agreements, terms, and conditions (<https://en.globtek.com/terms-and-conditions/>).

The purchaser of this product (Customer) agrees that it is their sole responsibility to determine suitability/fitness of the product described in this specification for their application and to take precautions for protection against any hazards attendant to the handling and use of the product.

Footnote:

GlobTek Inc. will not be liable for the safety and performance of these power supplies/battery packs if unauthorized access and repair occurs. End user should consult applicable UL, CSA or EN standards for proper installation instruction.

Limitation of Use:

GlobTek products are intended for use with commercial, medical, and/or industrial equipment only. GlobTek product are not authorized for use as mission critical components in life support hazardous environment, nuclear or aircraft applications without prior written approval from the CEO of GlobTek Inc.

Contents of this document are subject to change without prior notice.

### Customer Approval of Specification:

Please approve, sign and send back to GlobTek so we can complete order processing.

A delay in receipt of this form will delay delivery schedule.

|                                       |  |
|---------------------------------------|--|
| Company Name: _____                   | Customer P/N: _____                        |
| Quote Number: _____                   | Date: _____                                |
| Authorized Representative Name: _____ | Authorized Representative Signature: _____ |

|  |  |        |
|--|--|--------|
| GloTek, Inc.<br>www.globtek.com<br>186 Veterans Drive,<br>Northvale, NJ 07647<br>Tel. (201) 784-1000<br>Fax (201) 784-0111 | Drawing Title: GTM96600-4005-T2A, ICT / ITE / Medical Power Supply/Class 2/Household Power Supply, Efficiency Level: USA DOE Level VI / Eco-design Directive 2009/125/EC, (EU) 2019/1782, Case Color/Style: GlobTek Black, Desktop/External, Regulated Switchmode AC-DC Power Supply AC Adaptor, Input Rating: 100-240V~, 50-60Hz, IEC 60320/C18 , Output Rating: 40W, 5.0V@8.0A, Output Configuration: 1200 mm, 14/1C + Shield Cond, UL 1185, Female Barrel 5.5 * 2.5 * 11mm with internal Spring Clip and Locking Notch or Equal, Ferrite: Core size: 17.5*28.5*12.5, GlobTek Black, GT Cord # C5137, Pin Out: Center Positive (+V), symbol compliant with IEC 60417 symbol no. 5926, Blades/Input Cord: Not Applicable, Approvals: CB 60335; Fuse 60335; 230V CoC Tier 2; CB 62368; South Africa; cETLus 60601-1; IP41; UKCA; UL 1310; NRCAN (5V only); Morocco; Korea (9-15V Only); ETL; RCM; IRAM; PSE; PSE; PSE; CE; China RoHS; Level VI; RoHS; Ukraine; VCCI; WEEE; ETL 60950; S-Mark 60950; CB 60950; Double Insulation; CB 60601-1; S-Mark IEC/EN 60601-1; EAC; LPS 60950; South Africa; |        |
|  | Model No. GTM96600-4005-T2A  |        |
|  | Part No./Ordering No. TR9WA8000LCPIM(R6B)  | Rev C1 |

## REVISION HISTORY

| REV | DESCRIPTION  | SUB   | DATE       | APPROVED |
|-----|--|-------|------------|----------|
| C1  | Update label specs to ISO 15223 medical device compliant label, add UKCA approval        | QA    | 09/29/2020 | QA       |
| C   | Update approvals on the label  | QA    | 03/07/2019 | QA       |
| B   | Update output cord from 16 to 14AWG. Ferrite cord from RH 14.2*28.5*10 to 17.5*28.5*12.5 | rchiu | 07/13/2017 | QA       |
| A   | Initial Release  | jwarr | 05/02/2017 | QA       |

### POWER SUPPLY INFORMATION

|                                |  |
|--------------------------------|--|
| TYPE                           | Desktop/External   |
| TECHNOLOGY                     | Regulated Switchmode AC-DC Power Supply AC Adaptor   |
| CASE COLOR                     | GlobTek Black  |
| NAMEPLATE RATED INPUT          | 100-240V~, 50-60Hz, 1.5A   |
| INPUT CONFIG                   | IEC 60320/C18  |
| WATTS                          | 40.00  |
| VOLTS OUT                      | 5.0  |
| CURRENT OUT (Amps)             | 8.0  |
| BLADE/CORD INCLUDED            | N/A Not Applicable   |
| BLADE/CORD INSTALLED           | N/A :Not Applicable  |
| INGRESS PROTECTION             | IP41   |
| GROUNDING CONFIGURATION        | (F1) Class II / Double Insulated   |
| EFFICIENCY LEVEL               | <a href="#">USA DOE Level VI</a> / <a href="#">Eco-design Directive 2009/125/EC, (EU) 2019/1782</a> - <a href="#">Europe Code of Conduct on Energy Efficiency of External Power Supplies - Version 5</a> |
| OUTPUT CONFIGURATION           | 1200 mm, 14/1C + Shield Cond, UL 1185, Female Barrel 5.5 * 2.5 * 11mm with internal Spring Clip and Locking Notch or Equal, Ferrite: Core size: 17.5*28.5*12.5, GlobTek Black, GT Cord # C5137           |
| CONNECTOR PIN OUT              | Center Positive (+V), symbol compliant with IEC 60417 symbol no. 5926  |
| LABEL SPECS                    | ISO 15223 medical device compliant label,L-1470  |
| SPECIAL BARCODE LABEL MATERIAL | No   |
| PACK SPEC                      | Standard DT, Individually Box, GT User Manual  |
| USER MANUAL                    | 809-DESKTOPUSERMANUAL on A4 paper  |

#### PROPRIETARY INFORMATION

PROPRIETARY OF GLOBTEK, INC. ANY REPRODUCTION, DISCLOSURE OR USE OF THIS DRAWING, IN WHOLE OR IN PART, IS HEREBY PROHIBITED EXCEPT AS SPECIFIED IN WRITING BY GLOBTEK, INC. © GlobTek, Inc. 2017 - 2023

|  |  |        |
|--|--|--------|
| GloTek, Inc.<br>www.globtek.com<br>186 Veterans Drive,<br>Northvale, NJ 07647<br>Tel. (201) 784-1000<br>Fax (201) 784-0111 | Drawing Title: GTM96600-4005-T2A, ICT / ITE / Medical Power Supply/Class 2/Household Power Supply, Efficiency Level: USA DOE Level VI / Eco-design Directive 2009/125/EC, (EU) 2019/1782, Case Color/Style: GlobTek Black, Desktop/External, Regulated Switchmode AC-DC Power Supply AC Adaptor, Input Rating: 100-240V~, 50-60Hz, IEC 60320/C18 , Output Rating: 40W, 5.0V@8.0A, Output Configuration: 1200 mm, 14/1C + Shield Cond, UL 1185, Female Barrel 5.5 * 2.5 * 11mm with internal Spring Clip and Locking Notch or Equal, Ferrite: Core size: 17.5*28.5*12.5, GlobTek Black, GT Cord # C5137, Pin Out: Center Positive (+V), symbol compliant with IEC 60417 symbol no. 5926, Blades/Input Cord: Not Applicable, Approvals: CB 60335; Fuse 60335; 230V CoC Tier 2; CB 62368; South Africa; cETLus 60601-1; IP41; UKCA; UL 1310; NRCAN (5V only); Morocco; Korea (9-15V Only); ETL; RCM; IRAM; PSE; PSE; PSE; CE; China RoHS; Level VI; RoHS; Ukraine; VCCI; WEEE; ETL 60950; S-Mark 60950; CB 60950; Double Insulation; CB 60601-1; S-Mark IEC/EN 60601-1; EAC; LPS 60950; South Africa; |        |
|  | Model No. GTM96600-4005-T2A  |        |
|  | Part No./Ordering No. TR9WA8000LCPIM(R6B)  | Rev C1 |

Notes/Modifications/Customizations (notes in this section supersede the values shown in the standard spec)

DIMENSIONS ARE IN MM UNLESS SPECIFIED OTHERWISE

|  |   |        |
|--|---|--------|
| GloTek, Inc.<br>www.globtek.com<br>186 Veterans Drive,<br>Northvale, NJ 07647<br>Tel. (201) 784-1000<br>Fax (201) 784-0111 | Drawing Title: GTM96600-4005-T2A, ICT / ITE / Medical Power Supply/Class 2/Household Power Supply, Efficiency Level: USA DOE Level VI / Eco-design Directive 2009/125/EC, (EU) 2019/1782, Case Color/Style: GlobTek Black, Desktop/External, Regulated Switchmode AC-DC Power Supply AC Adaptor, Input Rating: 100-240V~, 50-60Hz, IEC 60320/C18, Output Rating: 40W, 5.0V@8.0A, Output Configuration: 1200 mm, 14/1C + Shield Cond, UL 1185, Female Barrel 5.5 * 2.5 * 11mm with internal Spring Clip and Locking Notch or Equal, Ferrite: Core size: 17.5*28.5*12.5, GlobTek Black, GT Cord # C5137, Pin Out: Center Positive (+V), symbol compliant with IEC 60417 symbol no. 5926, Blades/Input Cord: Not Applicable, Approvals: CB 60335; Fuse 60335; 230V CoC Tier 2; CB 62368; South Africa; cETLus 60601-1; IP41; UKCA; UL 1310; NRCAN (5V only); Morocco; Korea (9-15V Only); ETL; RCM; IRAM; PSE; PSE; PSE; CE; China RoHS; Level VI; RoHS; Ukraine; VCCL; WEEE; ETL 60950; S-Mark 60950; CB 60950; Double Insulation; CB 60601-1; S-Mark IEC/EN 60601-1; EAC; LPS 60950; South Africa; |        |
|  | Model No. GTM96600-4005-T2A   |        |
|  | Part No./Ordering No. TR9WA8000LCPIM(R6B)   | Rev C1 |

## ELECTRICAL SPECIFICATIONS

### Input

|                      |  |
|----------------------|--|
| Input Voltage:       | Specified: 90-264VAC, Nameplate: 100-240VAC<br>100% rated load current for 90-264VAC<br>85% rated load current for 85-264VAC<br>100% rated load current for 110-370VDC |
| Input Frequency:     | Specified: 47-63Hz, Nameplate: 50-60Hz   |
| No Load Input Power: | <75mW @ 230VAC (EU CoC Tier 2 compliant) for ≤ 49W rating<br><150mW @ 230VAC (EU CoC Tier 2 compliant) for > 49W rating  |
| Inrush Current:      | 30A/60A max. (cold start @ 115V/230VAC)  |
| Efficiency:          | DoE Level VI and EU CoC Tier 2 compliant   |

### Output

|                     |  |
|---------------------|--|
| Turn-on Delay:      | 1 second max. @ 115VAC and full load   |
| Output Regulation:  | ± 5% (measured at output connector)  |
| Line Regulation:    | ± 0.5% typ. (measured at output connector)   |
| Ripple:             | 1% or 100mV, whichever is greater (using a 47µF low-ESR cap + 0.1µF ceramic capacitor, measured @ 20MHz BW, at output connector) |
| Transient Response: | 5% max. deviation, 1ms typ. recovery time (with 40% to 70% load step)  |
| Hold-up Time:       | 8ms typ. (nominal input voltage and full load)   |
| Power Indicator:    | Green LED  |

### Protections

|                              |   |
|------------------------------|---|
| Input Protection:            | MOV transient suppressor, input line fusing   |
| Over-Current Protection:     | 110 - 160% of rated output current, auto-restart, current limit range determined by normal output power rating, not de-rated power rating |
| Short-Circuit Protection:    | Auto-restart  |
| Over-Voltage Protection:     | 110 - 130%, latched off, cycle AC to reset  |
| Over-Temperature Protection: | On-chip temperature sensor (integrated in primary-side switching controller), shut down at Tj = ~140°C, latched off, cycle AC to reset    |

### Environmental

|                        |   |
|------------------------|---|
| MTBF:                  | 1,500,000 hours @ 25°C ambient, full load (Telcordia SR-332, Issue 3) |
| Operating Temperature: | -20°C to 40°C (full load)   |
| Storage Temperature:   | -30°C to 80°C   |
| Humidity:              | 0% to 95% relative humidity, non-condensing                           |

#### PROPRIETARY INFORMATION

PROPRIETARY OF GLOBTEK, INC. ANY REPRODUCTION, DISCLOSURE OR USE OF THIS DRAWING, IN WHOLE OR IN PART, IS HEREBY PROHIBITED EXCEPT AS SPECIFIED IN WRITING BY GLOBTEK, INC. © GlobTek, Inc. 2017 - 2023

|  |   |        |
|--|---|--------|
| GloTek, Inc.<br>www.globtek.com<br>186 Veterans Drive,<br>Northvale, NJ 07647<br>Tel. (201) 784-1000<br>Fax (201) 784-0111 | Drawing Title: GTM96600-4005-T2A, ICT / ITE / Medical Power Supply/Class 2/Household Power Supply, Efficiency Level: USA DOE Level VI / Eco-design Directive 2009/125/EC, (EU) 2019/1782, Case Color/Style: GlobTek Black, Desktop/External, Regulated Switchmode AC-DC Power Supply AC Adaptor, Input Rating: 100-240V~, 50-60Hz, IEC 60320/C18, Output Rating: 40W, 5.0V@8.0A, Output Configuration: 1200 mm, 14/1C + Shield Cond, UL 1185, Female Barrel 5.5 * 2.5 * 11mm with internal Spring Clip and Locking Notch or Equal, Ferrite: Core size: 17.5*28.5*12.5, GlobTek Black, GT Cord # C5137, Pin Out: Center Positive (+V), symbol compliant with IEC 60417 symbol no. 5926, Blades/Input Cord: Not Applicable, Approvals: CB 60335; Fuse 60335; 230V CoC Tier 2; CB 62368; South Africa; cETLus 60601-1; IP41; UKCA; UL 1310; NRCAN (5V only); Morocco; Korea (9-15V Only); ETL; RCM; IRAM; PSE; PSE; PSE; CE; China RoHS; Level VI; RoHS; Ukraine; VCCI; WEEE; ETL 60950; S-Mark 60950; CB 60950; Double Insulation; CB 60601-1; S-Mark IEC/EN 60601-1; EAC; LPS 60950; South Africa; |        |
|  | Model No. GTM96600-4005-T2A   |        |
|  | Part No./Ordering No. TR9WA8000LCPIM(R6B)   | Rev C1 |

|           |  |
|-----------|--|
| Altitude: | 5000m  |
| Cooling:  | Convection   |
| RoHS:     | Complies with EU 2011/65/EU and China SJ/T 11363-2006  |
| Note 1:   | Regarding operating temperature<br>a. See below de-rating table for output power capability at alternate temperature<br>b. Extended low-end temperature range available as a custom option |

## Safety

|                               |  |
|-------------------------------|--|
| Dielectric Withstand Voltage: | 4000VAC or 5656VDC from input to output<br>3000VAC or 4242VDC from input to earth (Class I models only)  |
| Touch Current:                | Class I: 20µA max.<br>Class II: 85µA max.<br>Class II F2: 20µA max.  |
| Earth Leakage Current         | Class I: 300µA max.<br>Class II: N/A   |
| Means of Protection:          | 2 x MOPP   |
| Output Isolation Options:     | Class I: C6 or C14 inlet (output negative tied to Earth contact)<br>Class II: C8 or C18 inlet<br>Class II FE: C6 or C14 inlet (output isolated from Earth contact)<br>Review isolation options by reading our white paper <a href="#">PSU Isolation and Identity</a> . |
| Earth Continuity Test:        | < 0.1Ω between earth pin (on AC inlet) and PCB termination point (Class I models only)   |
| Compliant Standards:          | See listing at end of this datasheet for specific standards  |

## EMC

|  |  |
|--|--|
| Applicable Standards:                    | Medical: EN60601-1-2, 4th edition<br>Emissions: EN55032, EN61000-6-3, EN61000-6-4, CISPR11, CISPR22<br>Immunity: EN55024, EN61000-6-1, EN61000-6-2 |
| Conducted Emissions:                     | Class B, FCC Part 15, Class B (with resistive load)  |
| Radiated Emissions:                      | Class B, FCC Part 15, Class B (with resistive load)  |
| Harmonic Current Voltage Distortion:     | EN61000-3-2, Class A   |
| Voltage Fluctuations/Flicker:            | EN61000-3-3  |
| Electrostatic Discharge (ESD) Immunity:  | EN61000-4-2, 10KV contact discharge, 20KV air discharge  |
| Radiated RF Immunity:                    | EN61000-4-3, 10V/m 80-1000MHz, 3V/m 1-2.7GHz, 80% 1KHz AM  |
| EFT/Burst Immunity:                      | EN61000-4-4, 4KV/100kHz.   |
| Line Surge Immunity:                     | EN61000-4-5, 2KV differential, 4KV common-mode   |
| Conducted RF Immunity:                   | EN61000-4-6, 3VRMS, 80% 1KHz AM  |
| Power Frequency Magnetic Field Immunity: | EN61000-4-8, 3A/m  |
| Voltage Dip Immunity:                    | EN61000-4-11   |

## Enclosure

|  |   |        |
|--|---|--------|
| GloTek, Inc.<br>www.globtek.com<br>186 Veterans Drive,<br>Northvale, NJ 07647<br>Tel. (201) 784-1000<br>Fax (201) 784-0111 | Drawing Title: GTM96600-4005-T2A, ICT / ITE / Medical Power Supply/Class 2/Household Power Supply, Efficiency Level: USA DOE Level VI / Eco-design Directive 2009/125/EC, (EU) 2019/1782, Case Color/Style: GlobTek Black, Desktop/External, Regulated Switchmode AC-DC Power Supply AC Adaptor, Input Rating: 100-240V~, 50-60Hz, IEC 60320/C18, Output Rating: 40W, 5.0V@8.0A, Output Configuration: 1200 mm, 14/1C + Shield Cond, UL 1185, Female Barrel 5.5 * 2.5 * 11mm with internal Spring Clip and Locking Notch or Equal, Ferrite: Core size: 17.5*28.5*12.5, GlobTek Black, GT Cord # C5137, Pin Out: Center Positive (+V), symbol compliant with IEC 60417 symbol no. 5926, Blades/Input Cord: Not Applicable, Approvals: CB 60335; Fuse 60335; 230V CoC Tier 2; CB 62368; South Africa; cETLus 60601-1; IP41; UKCA; UL 1310; NRCAN (5V only); Morocco; Korea (9-15V Only); ETL; RCM; IRAM; PSE; PSE; PSE; CE; China RoHS; Level VI; RoHS; Ukraine; VCCI; WEEE; ETL 60950; S-Mark 60950; CB 60950; Double Insulation; CB 60601-1; S-Mark IEC/EN 60601-1; EAC; LPS 60950; South Africa; |        |
|  | Model No. GTM96600-4005-T2A   |        |
|  | Part No./Ordering No. TR9WA8000LCPIM(R6B)   | Rev C1 |

|                              |  |
|------------------------------|--|
| Housing:                     | High impact plastic, 94V0 polycarbonate, non-vented  |
| AC Input Mechanical Options: | Desktop: C6, C7, C14, or C18 inlet<br>Hybrid: Desktop inlet or changeable blades for wall-plug-in style, Class I or Class II input |
| Markings:                    | Label and/or pad printed and/or laser-etched into case   |

## Special Options

1. Removal of LED (cost reduction or aesthetic purpose)
2. Custom cordsets, various cordage types, and connector types
3. Custom markings
4. Short term output surge capability for motors or other high peak current loads. (Available up to 120W for 1 second at nameplate voltage range. Higher levels possible for limited input voltage range, or larger allowed voltage dip.)
5. Reduced leakage current
6. Tightened output voltage tolerance
7. Reduced output ripple level
8. Reduced output power rating
9. High reliability PCB laminate with plated through-holes for IPC610 Class 2 compliance
10. Low temperature option, down to -40°C
11. Special housing and cordset colors
12. "Back EMF" upgrade, for motor loads and other high inductance applications with reverse energy flow requirements
13. Improved ingress protection (IP) rating

## Output Connectors

- Several output connector options are available with various output current ratings. GlobTek can supply 10A rated 2.1mm and 2.5mm style DC Power Jacks, to complement our 10A output rated 2.1mm and 2.5mm DC power plugs used on our output cordsets.
- Please visit our real-time listing of mating connector product offering:  
<https://en.globtek.com/news/high-current-coaxial-barrel-plug-jacks-for-high-wattage-power-supplies>

TO ADDRESS SYSTEM-LEVEL EMI CONCERNS, FERRITE CHOKES/BEADS MAY BE ADDED/REVISED UPON REQUEST. A SAMPLE KIT OF GLOBTEK'S STANDARD FERRITES IS AVAILABLE UNDER GLOBTEK P/N: EMI-MITIGATION-KIT1

FOR ADDITIONAL INFORMATION, PLEASE READ OUR WHITE PAPER AT: <https://r.globtek.info/3QeaqtD>

INGRESS PROTECTION: IP41

|   |   |               |
|---|---|---------------|
| <p>GlobTek, Inc.<br/>www.globtek.com<br/>186 Veterans Drive,<br/>Northvale, NJ 07647<br/>Tel. (201) 784-1000<br/>Fax (201) 784-0111</p> | <p>Drawing Title: GTM96600-4005-T2A, ICT / ITE / Medical Power Supply/Class 2/Household Power Supply, Efficiency Level: USA DOE Level VI / Eco-design Directive 2009/125/EC, (EU) 2019/1782, Case Color/Style: GlobTek Black, Desktop/External, Regulated Switchmode AC-DC Power Supply AC Adaptor, Input Rating: 100-240V~, 50-60Hz, IEC 60320/C18 , Output Rating: 40W, 5.0V@8.0A, Output Configuration: 1200 mm, 14/1C + Shield Cond, UL 1185, Female Barrel 5.5 * 2.5 * 11mm with internal Spring Clip and Locking Notch or Equal, Ferrite: Core size: 17.5*28.5*12.5, GlobTek Black, GT Cord # C5137, Pin Out: Center Positive (+V), symbol compliant with IEC 60417 symbol no. 5926, Blades/Input Cord: Not Applicable, Approvals: CB 60335; Fuse 60335; 230V CoC Tier 2; CB 62368; South Africa; cETLus 60601-1; IP41; UKCA; UL 1310; NRCAN (5V only); Morocco; Korea (9-15V Only); ETL; RCM; IRAM; PSE; PSE; PSE; CE; China RoHS; Level VI; RoHS; Ukraine; VCCI; WEEE; ETL 60950; S-Mark 60950; CB 60950; Double Insulation; CB 60601-1; S-Mark IEC/EN 60601-1; EAC; LPS 60950; South Africa;</p> |               |
|   | <p>Model No. GTM96600-4005-T2A</p>  |               |
|   | <p>Part No./Ordering No. TR9WA8000LCPIM(R6B)</p>  | <p>Rev C1</p> |

3D File Download <https://www.globtek.com/dl/GTM96600-T2A.igs>

Mechanical drawing

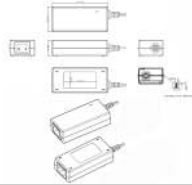

|   |   |   |
|---|---|---|
| GlobTek, Inc.<br>www.globtek.com<br>186 Veterans Drive,<br>Northvale, NJ 07647<br>Tel. (201) 784-1000<br>Fax (201) 784-0111 | Drawing Title: GTM96600-4005-T2A, ICT / ITE / Medical Power Supply/Class 2/Household Power Supply, Efficiency Level: USA DOE Level VI / Eco-design Directive 2009/125/EC, (EU) 2019/1782, Case Color/Style: GlobTek Black, Desktop/External, Regulated Switchmode AC-DC Power Supply AC Adaptor, Input Rating: 100-240V~, 50-60Hz, IEC 60320/C18, Output Rating: 40W, 5.0V@8.0A, Output Configuration: 1200 mm, 14/1C + Shield Cond, UL 1185, Female Barrel 5.5 * 2.5 * 11mm with internal Spring Clip and Locking Notch or Equal, Ferrite: Core size: 17.5*28.5*12.5, GlobTek Black, GT Cord # C5137, Pin Out: Center Positive (+V), symbol compliant with IEC 60417 symbol no. 5926, Blades/Input Cord: Not Applicable, Approvals: CB 60335; Fuse 60335; 230V CoC Tier 2; CB 62368; South Africa; cETLus 60601-1; IP41; UKCA; UL 1310; NRCAN (5V only); Morocco; Korea (9-15V Only); ETL; RCM; IRAM; PSE; PSE; PSE; CE; China RoHS; Level VI; RoHS; Ukraine; VCCI; WEEE; ETL 60950; S-Mark 60950; CB 60950; Double Insulation; CB 60601-1; S-Mark IEC/EN 60601-1; EAC; LPS 60950; South Africa; |   |
|   | Model No. GTM96600-4005-T2A   | Part No./Ordering No. TR9WA8000LCPIM(R6B) |
|   |   | Rev C1                                    |

DERATING CURVE

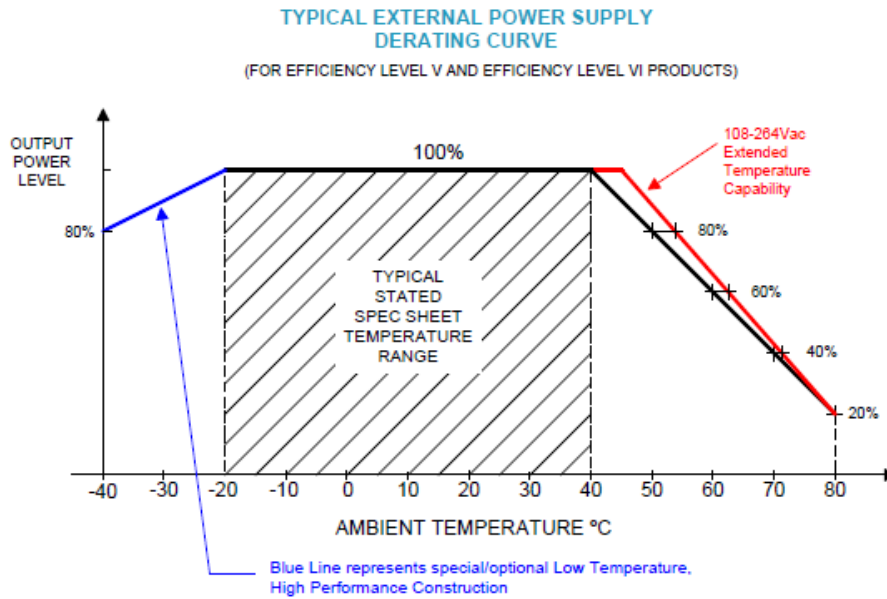



|  |  |        |
|--|--|--------|
| GloTek, Inc.<br>www.globtek.com<br>186 Veterans Drive,<br>Northvale, NJ 07647<br>Tel. (201) 784-1000<br>Fax (201) 784-0111 | Drawing Title: GTM96600-4005-T2A, ICT / ITE / Medical Power Supply/Class 2/Household Power Supply, Efficiency Level: USA DOE Level VI / Eco-design Directive 2009/125/EC, (EU) 2019/1782, Case Color/Style: GlobTek Black, Desktop/External, Regulated Switchmode AC-DC Power Supply AC Adaptor, Input Rating: 100-240V~, 50-60Hz, IEC 60320/C18 , Output Rating: 40W, 5.0V@8.0A, Output Configuration: 1200 mm, 14/1C + Shield Cond, UL 1185, Female Barrel 5.5 * 2.5 * 11mm with internal Spring Clip and Locking Notch or Equal, Ferrite: Core size: 17.5*28.5*12.5, GlobTek Black, GT Cord # C5137, Pin Out: Center Positive (+V), symbol compliant with IEC 60417 symbol no. 5926, Blades/Input Cord: Not Applicable, Approvals: CB 60335; Fuse 60335; 230V CoC Tier 2; CB 62368; South Africa; cETLus 60601-1; IP41; UKCA; UL 1310; NRCAN (5V only); Morocco; Korea (9-15V Only); ETL; RCM; IRAM; PSE; PSE; PSE; CE; China RoHS; Level VI; RoHS; Ukraine; VCCI; WEEE; ETL 60950; S-Mark 60950; CB 60950; Double Insulation; CB 60601-1; S-Mark IEC/EN 60601-1; EAC; LPS 60950; South Africa; |        |
|  | Model No. GTM96600-4005-T2A  |        |
|  | Part No./Ordering No. TR9WA8000LCPIM(R6B)  | Rev C1 |

## INPUT CONFIGURATION

(F1) Class II / Double Insulated

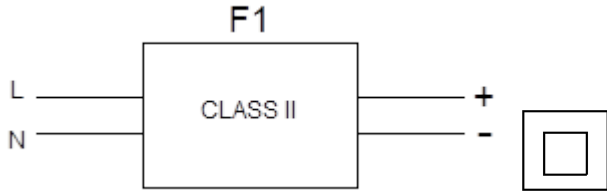

[Alternate grounding configurations](#) available upon request.

Blades/Cord Included:N/A:Not Applicable

Blades/Cord Installed:N/A:Not Applicable

IEC 60320/C18 AC Inlet connector, Class II, Non-Earth Ground

Mates with IEC 60320/C17 Plug



### [Standard International IEC 320/C17 Cordsets](#)

Below are standard cordsets which are "not included" (unless stated above); these may be purchased separately or packaged with the power supply. Please contact your Sales Engineer if the style required is not shown below. Many more available in different lengths, colors or cable material.

| Part Number/ Link                | Country               | Plug      | Termination | Length (mm) | Length (Ft) |
|----------------------------------|-----------------------|-----------|-------------|-------------|-------------|
| <a href="#">209A4062M071(R)</a>  | Argentina (Type I)    | IRAM 2063 | IEC320/C17  | 2000        | 6.6         |
| <a href="#">5014112M071A(R)</a>  | Australia (Type I)    | AS3112    | IEC 320/C17 | 2000        | 6           |
| <a href="#">204B4062M071(R)</a>  | Brazil (Type N)       | NRR 14136 | IEC320/C17  | 2000        | 6.6         |
| <a href="#">4533502M071(R)</a>   | China (Type A)        | GB 2099.1 | IEC320/C17  | 2000        | 6.6         |
| <a href="#">2074232M071C(R)</a>  | Europe (2.5A, Type C) | CEE 7/7   | IEC 320/C17 | 2000        | 6.6         |
| <a href="#">489C4232M071A(R)</a> | Europe (10A)          | CEE 7/17  | IEC320/C17  | 2000        | 6.6         |

PROPRIETARY INFORMATION

PROPRIETARY OF GLOBTEK, INC. ANY REPRODUCTION, DISCLOSURE OR USE OF THIS DRAWING, IN WHOLE OR IN PART, IS HEREBY PROHIBITED EXCEPT AS SPECIFIED IN WRITING BY GLOBTEK, INC. © GlobTek, Inc. 2017 - 2023

Page 9 of 17

quest / 08/07/2023 10:05:20 AM GMT

|   |  |        |
|---|--|--------|
| GlobTek, Inc.<br>www.globtek.com<br>186 Veterans Drive,<br>Northvale, NJ 07647<br>Tel. (201) 784-1000<br>Fax (201) 784-0111 | Drawing Title: GTM96600-4005-T2A, ICT / ITE / Medical Power Supply/Class 2/Household Power Supply, Efficiency Level: USA DOE Level VI / Eco-design Directive 2009/125/EC, (EU) 2019/1782, Case Color/Style: GlobTek Black, Desktop/External, Regulated Switchmode AC-DC Power Supply AC Adaptor, Input Rating: 100-240V~, 50-60Hz, IEC 60320/C18 , Output Rating: 40W, 5.0V@8.0A, Output Configuration: 1200 mm, 14/1C + Shield Cond, UL 1185, Female Barrel 5.5 * 2.5 * 11mm with internal Spring Clip and Locking Notch or Equal, Ferrite: Core size: 17.5*28.5*12.5, GlobTek Black, GT Cord # C5137, Pin Out: Center Positive (+V), symbol compliant with IEC 60417 symbol no. 5926, Blades/Input Cord: Not Applicable, Approvals: CB 60335; Fuse 60335; 230V CoC Tier 2; CB 62368; South Africa; cETLus 60601-1; IP41; UKCA; UL 1310; NRCAN (5V only); Morocco; Korea (9-15V Only); ETL; RCM; IRAM; PSE; PSE; PSE; CE; China RoHS; Level VI; RoHS; Ukraine; VCCI; WEEE; ETL 60950; S-Mark 60950; CB 60950; Double Insulation; CB 60601-1; S-Mark IEC/EN 60601-1; EAC; LPS 60950; South Africa; |        |
|   | Model No. GTM96600-4005-T2A  |        |
|   | Part No./Ordering No. TR9WA8000LCPIM(R6B)  | Rev C1 |

|                                   |  |                  |             |      |     |
|-----------------------------------|--|------------------|-------------|------|-----|
| <a href="#">208A4111M8071A(R)</a> | India (Type D)                                       | IS 1293          | IEC 320/C17 | 1800 | 6   |
| <a href="#">451J3322M071A</a>     | Japan (Type A)                                       | JIS 8303         | IEC320/C17  | 2000 | 6.6 |
| <a href="#">401P1086F071A(R)</a>  | North America (Type A)                               | NEMA 1-15P       | IEC 320/C17 | 1828 | 6   |
| <a href="#">401P1219F71A</a>      | North America (Type A)                               | NEMA 1-15P       | IEC 320/C17 | 2743 | 9   |
| <a href="#">4033321M8071(R)</a>   | Taiwan (Type A)                                      | CNS10917         | IEC 320/C17 | 1800 | 6   |
| <a href="#">6104232M071A(R)</a>   | UK, Hong Kong,<br>Singapore, Gulf States<br>(Type G) | BS1363 (Fuse 3A) | IEC 320/C17 | 2000 | 6.6 |
| <a href="#">6303742M571A(R)</a>   | Thailand (Type C)                                    | TIS 166-2549     | IEC 320/C17 | 2500 | 8   |

|   |  |        |
|---|--|--------|
| GlobTek, Inc.<br>www.globtek.com<br>186 Veterans Drive,<br>Northvale, NJ 07647<br>Tel. (201) 784-1000<br>Fax (201) 784-0111 | Drawing Title: GTM96600-4005-T2A, ICT / ITE / Medical Power Supply/Class 2/Household Power Supply, Efficiency Level: USA DOE Level VI / Eco-design Directive 2009/125/EC, (EU) 2019/1782, Case Color/Style: GlobTek Black, Desktop/External, Regulated Switchmode AC-DC Power Supply AC Adaptor, Input Rating: 100-240V~, 50-60Hz, IEC 60320/C18 , Output Rating: 40W, 5.0V@8.0A, Output Configuration: 1200 mm, 14/1C + Shield Cond, UL 1185, Female Barrel 5.5 * 2.5 * 11mm with internal Spring Clip and Locking Notch or Equal, Ferrite: Core size: 17.5*28.5*12.5, GlobTek Black, GT Cord # C5137, Pin Out: Center Positive (+V), symbol compliant with IEC 60417 symbol no. 5926, Blades/Input Cord: Not Applicable, Approvals: CB 60335; Fuse 60335; 230V CoC Tier 2; CB 62368; South Africa; cETLus 60601-1; IP41; UKCA; UL 1310; NRCAN (5V only); Morocco; Korea (9-15V Only); ETL; RCM; IRAM; PSE; PSE; PSE; CE; China RoHS; Level VI; RoHS; Ukraine; VCCI; WEEE; ETL 60950; S-Mark 60950; CB 60950; Double Insulation; CB 60601-1; S-Mark IEC/EN 60601-1; EAC; LPS 60950; South Africa; |        |
|   | Model No. GTM96600-4005-T2A  |        |
|   | Part No./Ordering No. TR9WA8000LCPIM(R6B)  | Rev C1 |

**OUTPUT CORD AND CONNECTOR: LCL/C5137**

ACTUAL CONNECTORS, OVERMOLDS, FERRITES MAY VARY SLIGHTLY FROM THE PICTURE BELOW

|  |   |
|--|---|
| CABLE TYPE   | UL 1185   |
| CABLE LENGTH (mm)                                    | 1200  |
| CABLE TOLERANCE (mm)                                 | +/-50   |
| WIRE GAUGE (AWG)                                     | 14  |
| CONDUCTORS   | 1C + Shield   |
| HANK DIMENSION (mm)                                  | 80 ± 15   |
| CABLE / CONNECTOR OVERMOLD COLOR                     | GlobTek Black   |
| FERRITE TYPE AND DIMENSION                           | Core size: 17.5*28.5*12.5   |
| FERRITE NUMBER OF TURNS <a href="#">(Definition)</a> | 2 Pass thru core (1 turns)  |
| FERRITE DIMENSION FROM STRAIN RELIEF                 | 50+/-10   |
| FERRITE DIMENSION FROM PLUG                          | N/A   |
| PLUG TYPE  | Female Barrel 5.5 * 2.5 * 11mm with internal Spring Clip and Locking Notch or Equal |
| OVER MOLD ORIENTATION                                | Straight  |
| CONNECTOR PIN OUT                                    | Center Positive (+V), symbol compliant with IEC 60417 symbol no. 5926               |
| ADDITIONAL REQUIREMENTS                              | UL1310 Warning Label Up To 36 Volts with plugs                                      |

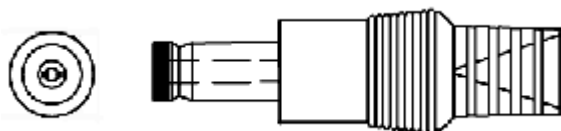

ADDITIONAL OUTPUT PLUG OPTIONS ARE AVAILABLE AT <https://www.globtek.com/connectors/>  
STANDARD PLUGS AND CONNECTORS CAN BE SEEN ONLINE AT <https://www.globtek.com/connectors/>  
CALCULATE VOLTAGE REGULATION/DROP WITH OUR ONLINE CALCULATOR: <https://en.globtek.com/output-cable-regulation-calculator/>

|   |  |        |
|---|--|--------|
| GlobTek, Inc.<br>www.globtek.com<br>186 Veterans Drive,<br>Northvale, NJ 07647<br>Tel. (201) 784-1000<br>Fax (201) 784-0111 | Drawing Title: GTM96600-4005-T2A, ICT / ITE / Medical Power Supply/Class 2/Household Power Supply, Efficiency Level: USA DOE Level VI / Eco-design Directive 2009/125/EC, (EU) 2019/1782, Case Color/Style: GlobTek Black, Desktop/External, Regulated Switchmode AC-DC Power Supply AC Adaptor, Input Rating: 100-240V~, 50-60Hz, IEC 60320/C18 , Output Rating: 40W, 5.0V@8.0A, Output Configuration: 1200 mm, 14/1C + Shield Cond, UL 1185, Female Barrel 5.5 * 2.5 * 11mm with internal Spring Clip and Locking Notch or Equal, Ferrite: Core size: 17.5*28.5*12.5, GlobTek Black, GT Cord # C5137, Pin Out: Center Positive (+V), symbol compliant with IEC 60417 symbol no. 5926, Blades/Input Cord: Not Applicable, Approvals: CB 60335; Fuse 60335; 230V CoC Tier 2; CB 62368; South Africa; cETLus 60601-1; IP41; UKCA; UL 1310; NRCAN (5V only); Morocco; Korea (9-15V Only); ETL; RCM; IRAM; PSE; PSE; PSE; CE; China RoHS; Level VI; RoHS; Ukraine; VCCI; WEEE; ETL 60950; S-Mark 60950; CB 60950; Double Insulation; CB 60601-1; S-Mark IEC/EN 60601-1; EAC; LPS 60950; South Africa; |        |
|   | Model No. GTM96600-4005-T2A  |        |
|   | Part No./Ordering No. TR9WA8000LCPIM(R6B)  | Rev C1 |

## OUTPUT CONNECTOR HOOK UP

TO ADDRESS SYSTEM-LEVEL EMI CONCERNS, FERRITE CHOKES/BEADS MAY BE ADDED/REVISED UPON REQUEST. A SAMPLE KIT OF GLOBTEK'S STANDARD FERRITES IS AVAILABLE UNDER GLOBTEK P/N: EMI-MITIGATION-KIT1

FOR ADDITIONAL INFORMATION, PLEASE READ OUR WHITE PAPER AT:

<https://en.globtek.com/technical-articles/ferrite-kit-radiated-emi-suppression-kit-for-globtek-power-supplies-cable-assemblies>

|  |  |        |
|--|--|--------|
| GloTek, Inc.<br>www.globtek.com<br>186 Veterans Drive,<br>Northvale, NJ 07647<br>Tel. (201) 784-1000<br>Fax (201) 784-0111 | Drawing Title: GTM96600-4005-T2A, ICT / ITE / Medical Power Supply/Class 2/Household Power Supply, Efficiency Level: USA DOE Level VI / Eco-design<br>Directive 2009/125/EC, (EU) 2019/1782, Case Color/Style: GlobTek Black, Desktop/External, Regulated Switchmode AC-DC Power Supply AC Adaptor, Input<br>Rating: 100-240V~, 50-60Hz, IEC 60320/C18, Output Rating: 40W, 5.0V@8.0A, Output Configuration: 1200 mm, 14/1C + Shield Cond, UL 1185, Female Barrel 5.5<br>* 2.5 * 11mm with internal Spring Clip and Locking Notch or Equal, Ferrite: Core size: 17.5*28.5*12.5, GlobTek Black, GT Cord # C5137, Pin Out: Center Positive<br>(+V), symbol compliant with IEC 60417 symbol no. 5926, Blades/Input Cord: Not Applicable, Approvals: CB 60335; Fuse 60335; 230V CoC Tier 2; CB 62368; South<br>Africa; cETLus 60601-1; IP41; UKCA; UL 1310; NRCAN (5V only); Morocco; Korea (9-15V Only); ETL; RCM; IRAM; PSE; PSE; CE; China RoHS; Level VI;<br>RoHS; Ukraine; VCCI; WEEE; ETL 60950; CB 60950; Double Insulation; CB 60601-1; S-Mark IEC/EN 60601-1; EAC; LPS 60950; South Africa; |        |
|  | Model No. GTM96600-4005-T2A  |        |
|  | Part No./Ordering No. TR9WA8000LCPIM(R6B)  | Rev C1 |

**LABEL:L-1470**

|                                |  |
|--------------------------------|--|
| LABEL P/N                      | ISO 15223 medical device compliant label   |
| MATERIAL                       | Flat Thermal Transfer, Imprintable, Polyester Label and/or Pad Printed and/or Molded, and/or Laser Engraved in the case                    |
| BACKGROUND COLOR               | Black if housing is Black, White or Silver if housing is White or Gray.  |
| TEXT COLOR                     | White or Silver if label is Black Background for Black housing. Black if label is White or Silver background and Housing is White or Gray. |
| LABEL WIDTH (mm)               | 35.0   |
| LABEL HEIGHT (mm)              | 70.0   |
| SPECIAL BARCODE LABEL MATERIAL | No   |

Below is the minimum information which will appear on the label. NOTE: in the logo area additional/actual positioning of symbols and text is subjected to change as per agency updates/requirements or additional model approvals become available.

Agency logos may be in Regulatory Certifications/Label Markings area on the label or molded into the case housing outside the label area. Information will be shown via Label and/or Pad Printed and/or Molded in the case.

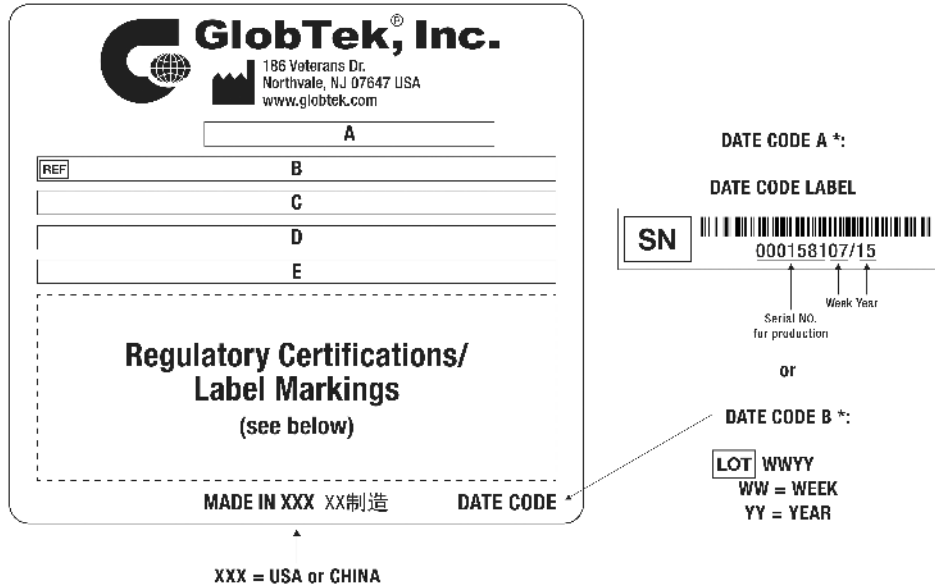

A=ICT / ITE / Medical Power Supply/Class 2/Household Power Supply  
B=P/N: (料号) TR9WA8000LCPIM(R6B)  
C=Model (型号) GTM96600-4005-T2A  
D=Input (输入)100-240V~, 50-60Hz, 1.5A  
E=Output (输出)5.0 V 8.0 A, 40.00W

|   |  |        |
|---|--|--------|
| GlobTek, Inc.<br>www.globtek.com<br>186 Veterans Drive,<br>Northvale, NJ 07647<br>Tel. (201) 784-1000<br>Fax (201) 784-0111 | Drawing Title: GTM96600-4005-T2A, ICT / ITE / Medical Power Supply/Class 2/Household Power Supply, Efficiency Level: USA DOE Level VI / Eco-design Directive 2009/125/EC, (EU) 2019/1782, Case Color/Style: GlobTek Black, Desktop/External, Regulated Switchmode AC-DC Power Supply AC Adaptor, Input Rating: 100-240V~, 50-60Hz, IEC 60320/C18 , Output Rating: 40W, 5.0V@8.0A, Output Configuration: 1200 mm, 14/1C + Shield Cond, UL 1185, Female Barrel 5.5 * 2.5 * 11mm with internal Spring Clip and Locking Notch or Equal, Ferrite: Core size: 17.5*28.5*12.5, GlobTek Black, GT Cord # C5137, Pin Out: Center Positive (+V), symbol compliant with IEC 60417 symbol no. 5926, Blades/Input Cord: Not Applicable, Approvals: CB 60335; Fuse 60335; 230V CoC Tier 2; CB 62368; South Africa; cETLus 60601-1; IP41; UKCA; UL 1310; NRCAN (5V only); Morocco; Korea (9-15V Only); ETL; RCM; IRAM; PSE; PSE; PSE; CE; China RoHS; Level VI; RoHS; Ukraine; VCCI; WEEE; ETL 60950; S-Mark 60950; CB 60950; Double Insulation; CB 60601-1; S-Mark IEC/EN 60601-1; EAC; LPS 60950; South Africa; |        |
|   | Model No. GTM96600-4005-T2A  |        |
|   | Part No./Ordering No. TR9WA8000LCPIM(R6B)  | Rev C1 |

|   |   |
|---|---|
| AGENCY ONLINE DOCUMENTS   | <a href="http://www.globtek.info/certs/GTM96600-TZ/">http://www.globtek.info/certs/GTM96600-TZ/</a>   |
| CE EC-Declaration for Medical   | <a href="http://globtek.force.com/models/ec_declaration_product?id=01ta0000007dRGX&amp;m=1">http://globtek.force.com/models/ec_declaration_product?id=01ta0000007dRGX&amp;m=1</a>           |
| CE EC-Declaration for Industrial/Commercial/ITE   | <a href="http://globtek.force.com/models/ec_declaration_product?id=01ta0000007dRGX&amp;i=2">http://globtek.force.com/models/ec_declaration_product?id=01ta0000007dRGX&amp;i=2</a>           |
| CE EC-Declaration for Household   | <a href="http://globtek.force.com/models/ec_declaration_product?id=01ta0000007dRGX&amp;h=2">http://globtek.force.com/models/ec_declaration_product?id=01ta0000007dRGX&amp;h=2</a>           |
| UKCA-Declaration for Medical  | <a href="http://globtek.force.com/models/ukca_declaration_product?id=01ta0000007dRGX&amp;m=1">http://globtek.force.com/models/ukca_declaration_product?id=01ta0000007dRGX&amp;m=1</a>       |
| UKCA-Declaration for Industrial/Commercial/ITE  | <a href="http://globtek.force.com/models/ukca_declaration_product?id=01ta0000007dRGX&amp;i=2">http://globtek.force.com/models/ukca_declaration_product?id=01ta0000007dRGX&amp;i=2</a>       |
| UKCA-Declaration for Household  | <a href="http://globtek.force.com/models/ukca_declaration_product?id=01ta0000007dRGX&amp;h=2">http://globtek.force.com/models/ukca_declaration_product?id=01ta0000007dRGX&amp;h=2</a>       |
| Morocco SDoC Declaration  | <a href="https://globtek.secure.force.com/models/Morocco_SDoC_Declaration?id=a0Oa000000FiilYEAZ">https://globtek.secure.force.com/models/Morocco_SDoC_Declaration?id=a0Oa000000FiilYEAZ</a> |
| RoHS/RoHS3 Declaration  | <a href="https://www.globtek.com/pdf/rohs_cert/01ta0000007dRGXAA2">https://www.globtek.com/pdf/rohs_cert/01ta0000007dRGXAA2</a>   |
| REACH Declaration   | <a href="https://www.globtek.com/pdf/iso_certificates/REACH.pdf">https://www.globtek.com/pdf/iso_certificates/REACH.pdf</a>   |
| Conflict Minerals Declaration   | <a href="https://www.globtek.com/pdf/conflict-minerals.pdf">https://www.globtek.com/pdf/conflict-minerals.pdf</a>   |
| Prop 65 Statement   | <a href="https://en.globtek.com/prop-65-statement.pdf">https://en.globtek.com/prop-65-statement.pdf</a>   |
| IPXY rating is based on 3rd party testing and customers should check suitability and test system level IPXY rating before ordering. |   |

## Regulatory Certifications/Label Markings

Below follows a link to the latest regulatory certifications and marks for this specific product. National standards as well as certification schemes are constantly changing and so is the set of certification marks and symbols applicable to this product. Various standards, marks and symbols, and certificates are subject to change at any time without notice.

Additional standards or unique country certifications are available upon request. Please contact Globtek to request a quotation.

LATEST PRODUCT/MODEL CERTIFICATIONS: <https://www.globtek.com/datasheet/w70801>

AGENCY ONLINE DOCUMENTS <http://www.globtek.info/certs/GTM96600-TZ/>



(F1) Class II / Double Insulated

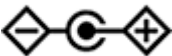

Center Positive (+V), symbol compliant with IEC 60417 symbol no. 5926

|   |  |        |
|---|--|--------|
| GlobTek, Inc.<br>www.globtek.com<br>186 Veterans Drive,<br>Northvale, NJ 07647<br>Tel. (201) 784-1000<br>Fax (201) 784-0111 | Drawing Title: GTM96600-4005-T2A, ICT / ITE / Medical Power Supply/Class 2/Household Power Supply, Efficiency Level: USA DOE Level VI / Eco-design Directive 2009/125/EC, (EU) 2019/1782, Case Color/Style: GlobTek Black, Desktop/External, Regulated Switchmode AC-DC Power Supply AC Adaptor, Input Rating: 100-240V~, 50-60Hz, IEC 60320/C18 , Output Rating: 40W, 5.0V@8.0A, Output Configuration: 1200 mm, 14/1C + Shield Cond, UL 1185, Female Barrel 5.5 * 2.5 * 11mm with internal Spring Clip and Locking Notch or Equal, Ferrite: Core size: 17.5*28.5*12.5, GlobTek Black, GT Cord # C5137, Pin Out: Center Positive (+V), symbol compliant with IEC 60417 symbol no. 5926, Blades/Input Cord: Not Applicable, Approvals: CB 60335; Fuse 60335; 230V CoC Tier 2; CB 62368; South Africa; cETLus 60601-1; IP41; UKCA; UL 1310; NRCAN (5V only); Morocco; Korea (9-15V Only); ETL; RCM; IRAM; PSE; PSE; PSE; CE; China RoHS; Level VI; RoHS; Ukraine; VCCL; WEEE; ETL 60950; S-Mark 60950; CB 60950; Double Insulation; CB 60601-1; S-Mark IEC/EN 60601-1; EAC; LPS 60950; South Africa; |        |
|   | Model No. GTM96600-4005-T2A  |        |
|   | Part No./Ordering No. TR9WA8000LCPIM(R6B)  | Rev C1 |

## PACKAGING

|                                 |   |
|---------------------------------|---|
| Packing Spec P/N                | Standard DT, Individually Box, GT User Manual   |
| Box Qty                         | 20  |
| Gift Box Size (mm)              | Egg Crate   |
| Gift Box Color                  | White   |
| Master Carton Size (mm)         | 427 x 405 x 158   |
| Master Carton Cubic Volume (m³) | 0.03  |
| Master GW (Kg)                  | 7.8 kg  |
| BLADES INCLUDED                 | N/A: Not Applicable   |
| BLADE/CORD INSTALLED            | N/A: Not Applicable   |
| USER MANUAL*                    | 809-DESKTOPUSERMANUAL on A4 paper   |
| USER MANUAL WEB LINK            | <a href="https://en.globtek.com/pdf/809-DESKTOPUSERMANUAL.jpg">https://en.globtek.com/pdf/809-DESKTOPUSERMANUAL.jpg</a> |

\* This specification sheet is considered the user manual for all applications. It is expected that the buyer of this product will use it to formulate their own user manual for their end product and a user manual specifically for the power adapter is not usually required. If a user manual is not specifically listed above then none will be provided with this unit.

If specific packaging is required, this section must specify all requirements and note "no exceptions". If this section does not specify packaging, it is subject to change without notice at GlobTek's discretion

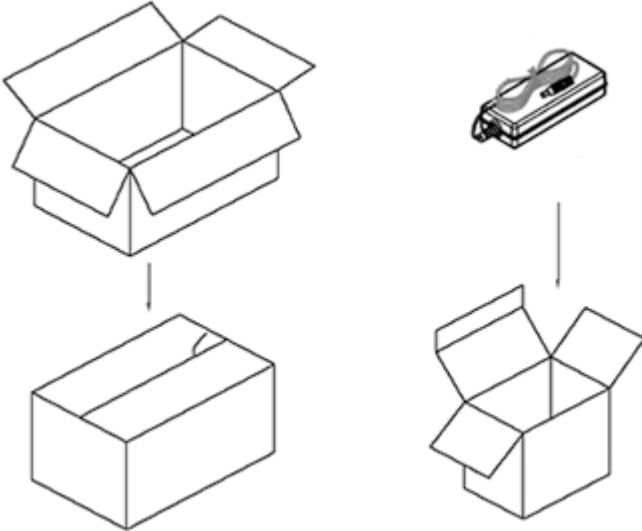

### PROPRIETARY INFORMATION

PROPRIETARY OF GLOBTEK, INC. ANY REPRODUCTION, DISCLOSURE OR USE OF THIS DRAWING, IN WHOLE OR IN PART, IS HEREBY PROHIBITED EXCEPT AS SPECIFIED IN Page 15 of 17

WRITING BY GLOBTEK, INC. © GlobTek, Inc. 2017 - 2023

quest / 08/07/2023 10:05:20 AM GMT

|   |  |        |
|---|--|--------|
| GlobTek, Inc.<br>www.globtek.com<br>186 Veterans Drive,<br>Northvale, NJ 07647<br>Tel. (201) 784-1000<br>Fax (201) 784-0111 | Drawing Title: GTM96600-4005-T2A, ICT / ITE / Medical Power Supply/Class 2/Household Power Supply, Efficiency Level: USA DOE Level VI / Eco-design Directive 2009/125/EC, (EU) 2019/1782, Case Color/Style: GlobTek Black, Desktop/External, Regulated Switchmode AC-DC Power Supply AC Adaptor, Input Rating: 100-240V~, 50-60Hz, IEC 60320/C18 , Output Rating: 40W, 5.0V@8.0A, Output Configuration: 1200 mm, 14/1C + Shield Cond, UL 1185, Female Barrel 5.5 * 2.5 * 11mm with internal Spring Clip and Locking Notch or Equal, Ferrite: Core size: 17.5*28.5*12.5, GlobTek Black, GT Cord # C5137, Pin Out: Center Positive (+V), symbol compliant with IEC 60417 symbol no. 5926, Blades/Input Cord: Not Applicable, Approvals: CB 60335; Fuse 60335; 230V CoC Tier 2; CB 62368; South Africa; cETLus 60601-1; IP41; UKCA; UL 1310; NRCAN (5V only); Morocco; Korea (9-15V Only); ETL; RCM; IRAM; PSE; PSE; PSE; CE; China RoHS; Level VI; RoHS; Ukraine; VCCI; WEEE; ETL 60950; S-Mark 60950; CB 60950; Double Insulation; CB 60601-1; S-Mark IEC/EN 60601-1; EAC; LPS 60950; South Africa; |        |
|   | Model No. GTM96600-4005-T2A  |        |
|   | Part No./Ordering No. TR9WA8000LCPIM(R6B)  | Rev C1 |

## INSTRUCTIONS TO THE OEM SYSTEMS ENGINEER

It is the responsibility of the OEM systems engineer to provide the end system user instructions and warnings for the use of this product in the end system.

If an input cord is required for this product, AC Mains voltage should be provided to the power supply by a power supply cord approved to the national standards of the country in which it will be used.

This product is not designed to be repaired. No serviceable parts inside. A blown internal fuse is an indication of catastrophic failure of circuit component(s). If a Failure Analysis is required for a failed power supply/battery charger, please return the damaged unit to GlobTek for an accurate determination of the root cause of the failure.

EMC Compliance of the complete OEM product, including the GlobTek power supply/battery charger needs to be verified by the OEM systems engineer.

## INSTRUCTION SHEET

N/A



|  |   |
|--|---|
| <p>GlobTek, Inc.<br/> www.globtek.com<br/> 186 Veterans Drive,<br/> Northvale, NJ 07647<br/> Tel. (201) 784-1000<br/> Fax (201) 784-0111</p> | <p>Drawing Title: GTM96600-4005-T2A, ICT / ITE / Medical Power Supply/Class 2/Household Power Supply, Efficiency Level: USA DOE Level VI / Eco-design Directive 2009/125/EC, (EU) 2019/1782, Case Color/Style: GlobTek Black, Desktop/External, Regulated Switchmode AC-DC Power Supply AC Adaptor, Input Rating: 100-240V~, 50-60Hz, IEC 60320/C18 , Output Rating: 40W, 5.0V@8.0A, Output Configuration: 1200 mm, 14/1C + Shield Cond, UL 1185, Female Barrel 5.5 * 2.5 * 11mm with internal Spring Clip and Locking Notch or Equal, Ferrite: Core size: 17.5*28.5*12.5, GlobTek Black, GT Cord # C5137, Pin Out: Center Positive (+V), symbol compliant with IEC 60417 symbol no. 5926, Blades/Input Cord: Not Applicable, Approvals: CB 60335; Fuse 60335; 230V CoC Tier 2; CB 62368; South Africa; cETLus 60601-1; IP41; UKCA; UL 1310; NRCAN (5V only); Morocco; Korea (9-15V Only); ETL; RCM; IRAM; PSE; PSE; PSE; CE; China RoHS; Level VI; RoHS; Ukraine; VCCI; WEEE; ETL 60950; S-Mark 60950; CB 60950; Double Insulation; CB 60601-1; S-Mark IEC/EN 60601-1; EAC; LPS 60950; South Africa;</p> |
|  | <p>Model No. GTM96600-4005-T2A</p>  |
|  | <p>Part No./Ordering No. TR9WA8000LCPIM(R6B) <span style="float: right;">Rev C1</span></p>  |

