

High-Voltage Power Discretes and Modules



Silicon Carbide (SiC) MOSFETs.....	3	Rugged Custom Power Modules	27
SiC MOSFETs Devices.....	4	Power Module Part Numbering System	29
Power MOS 8™ MOSFETs/FREDFETs	5	SiC MOSFET Power Module	30
Low-Voltage Power MOS V® MOSFETs/FREDFETs	6	High-Reliability Baseless Power Modules	31
Super Junction MOSFETs.....	9	Dual Common Source and Three Level Inverter Modules....	32
Linear MOSFETs	10	Baseless Power Modules	33
IGBTs	11	SiC Diode Power Module	34
IGBTs—Punch-Thru	12	IGBT and Si MOSFET Power Modules with SiC Parallel Diodes.....	35
IGBTs—Non-Punch-Thru.....	13	IGBT Power Modules	37
IGBTs—Field Stop.....	14	MOSFET Power Module.....	41
Schottky Barrier Diodes	15	Renewable Energy Power Module	45
SiC Schottky Barrier Diode (SBD) Devices	16	Diode Power Modules	45
High-Voltage RF MOSFETs	19	Power Discrete and Module Outlines	48
High-Frequency RF MOSFETs	20	AgileSwitch™ Configurable Digital Gate Driver Solutions	52
Drivers and Driver-RF MOSFET Hybrids	21	Configurable SiC Digital Gate Driver Cores.....	53
Power Modules Contents.....	22	SiC Solutions	54
Standard Electrical Configurations	23	MPLAB® Mindi™ and PLECS Simulation Model	55
Package Advantages.....	24	Sales and Support Information	56
High Reliability Baseless Packages	25		
Custom Power Modules.....	26		



Silicon Carbide (SiC) MOSFETs

Silicon Carbide (SiC) is the ideal technology for higher switching frequency, higher efficiency, and higher power (>650V) applications. Target markets and applications include:

- Transportation/automotive: Electric Vehicle (EV): battery charger, Hybrid Electric Vehicle (HEV) powertrain, DC-DC converter, energy recovery
- Data center: UPS, PDU, PSU (PFC/LLC) power supplies
- Commercial aviation: actuation, air conditioning, power distribution
- Industrial: induction heating, motor drives, SMPS, Uninterruptible Power Supply (UPS), welding
- Smart energy: energy storage, PhotoVoltaic (PV) inverter, wind (turbine)
- Medical: MRI power supply, X-ray power supply
- Defense: motor drives, power supplies

SiC MOSFET and SiC Schottky barrier diode product lines from Microchip increase your system efficiency over silicon MOSFET and IGBT solutions while lowering your cost of ownership by enabling downsized systems and smaller/lower cost cooling.

SiC MOSFET Features and Benefits

Characteristics	Results	Benefits
Breakdown field (MV/cm)	Lower on-resistance	Higher efficiency
Electron sat. velocity (cm/s)	Faster switching	Size reduction
Bandgap energy (ev)	Higher junction temperature	Improved cooling
Thermal conductivity (W/m.K)	Higher power density	Higher current capabilities
Positive temperature coefficient	Self regulation	Easy paralleling

Advantages Versus Competition: Quality, Supply, Support (QSS)

Quality

- RDSon stability over temperature
- High avalanche performance – UIS and repetitive UIS
- Long short circuit withstand time
- No lifetime degradation of the internal body diode

Supply

- Multiple qualified sources of substrate and epitaxy material
- Dual fabrication capability
- No EOL policy
- Competitive lead times

Support

- Broad power switching portfolio – Discretes, die and modules
- Microchip's Total System Solution (TSS) – Power stage, gate driver and control solutions
- Expertise and support infrastructure in Aerospace, Defense, Industrial and Automotive

SiC MOSFET Devices

Part Number	Voltage (V)	$R_{DS(on)}$ (m Ω)	Package	
MSC090SMA070B	700	90	TO-247	
MSC090SMA070S			D3PAK	
MSC060SMA070B			TO-247	
MSC060SMA070B4		60	TO-247-4L	
MSC060SMA070S			D3PAK	
MSC035SMA070B 			TO-247	
MSC035SMA070B4		35	TO-247-4L	
MSC035SMA070S			D3PAK	
MSC035SMA070J			SOT-227	
MSC015SMA070B		15	TO-247	TO-247
MSC015SMA070B4				TO-247-4L
MSC015SMA070S				D3PAK
MSC015SMA070J			SOT-227	
MSC360SMA120B				TO-247
MSC360SMA120S				D3PAK
MSC180SMA120B	180	TO-247		
MSC180SMA120S		D3PAK		
MSC080SMA120B		TO-247		
MSC080SMA120B4	80	TO-247-4L		
MSC080SMA120S		D3PAK		
MSC080SMA120J		SOT-227		
MSC040SMA120B	1200	40	TO-247	
MSC040SMA120B4			TO-247-4L	
MSC040SMA120S			D3PAK	
MSC040SMA120J		SOT-227		
MSC025SMA120B			TO-247	
MSC025SMA120B4			TO-247-4L	
MSC025SMA120S	25	D3PAK		
MSC025SMA120J		SOT-227		
MSC017SMA120B		TO-247		
MSC017SMA120B4	17	TO-247-4L		
MSC017SMA120J		SOT-227		
MSC017SMA120S		D3PAK		
MSC750SMA170B	1700	750	TO-247	
MSC750SMA170B4			TO-247-4L	
MSC750SMA170S			D3PAK	
MSC035SMA170B		35	TO-247	
MSC035SMA170B4			TO-247-4L	
MSC035SMA170S			D3PAK	
MSC400SMA330B4	3300	400	TO-247-4L	
MSC080SMA330B4		80	TO-247-4L	
MSC025SMA330B4		25	TO-247-4L	



D3PAK[S]

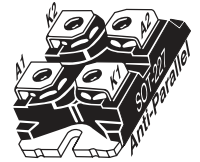

SOT-227[J]
Antiparallel
Configuration
(Isolated Base)



TO-247-4L

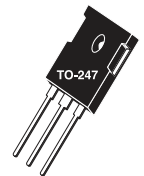

TO-247[B]

Power MOS 8™ MOSFETs/FREDFETs

BV _{DSS} (V)	R _{DS(on)} Max (Ω)	I _D (A)	MOSFET Part Number	I _D (A)	FREDFET Part Number	Package Style
1200	4.20			4	APT4F120K	TO-220
	4.20			4	APT4F120S	D3PAK
	3.80	5	APT4M120K			TO-220
	2.40			7	APT7F120B	TO-247 or D3PAK
	2.10	8	APT7M120B			TO-247
	1.20			14	APT13F120B	TO-247 or D3PAK
	1.10	14	APT14M120B			TO-247
	0.70			23	APT22F120B2	T-MAX® or TO-264
	0.63	24	APT24M120B2			T-MAX or TO-264
	0.58			27	APT26F120B2	T-MAX or TO-264
	0.58			18	APT17F120J	SOT-227
	0.53	29	APT28M120B2			T-MAX or TO-264
	0.53	19	APT19M120J			SOT-227
	0.32			33	APT32F120J	SOT-227
1000	2.00			7	APT7F100B	TO-247
	1.80	8	APT8M100B			TO-247
	1.60			9	APT9F100B	TO-247 or D3PAK
	1.40	9	APT9M100B			TO-247
	0.98			14	APT14F100B	TO-247 or D3PAK
	0.88	14	APT14M100B			TO-247 or D3PAK
	0.78			17	APT17F100B	TO-247 or D3PAK
	0.70	18	APT18M100B			TO-247
	0.44			30	APT29F100B2	T-MAX or TO-264
	0.44			20	APT19F100J	SOT-227
	0.38	32	APT31M100B2			T-MAX or TO-264
	0.38	21	APT21M100J			SOT-227
	0.38			35	APT34F100B2	T-MAX or TO-264
	0.38			23	APT22F100J	SOT-227
	0.33	37	APT37M100B2			T-MAX or TO-264
	0.33	25	APT25M100J			SOT-227
0.20			42	APT41F100J	SOT-227	
0.18	45	APT45M100J			SOT-227	
800	0.90			12	APT11F80B	TO-247 or D3PAK
	0.80	13	APT12M80B			TO-247
	0.58			18	APT17F80B	TO-247 or D3PAK
	0.53	19	APT18M80B			TO-247 or D3PAK
	0.43			23	APT22F80B	TO-247 or D3PAK
	0.39	25	APT24M80B			TO-247 or D3PAK
	0.24			41	APT38F80B2	T-MAX or TO-264
	0.21	43	APT41M80B2			T-MAX or TO-264
	0.21			47	APT44F80B2	T-MAX or TO-264
	0.21			31	APT29F80J	SOT-227
	0.19	49	APT48M80B2			T-MAX or TO-264
	0.19	33	APT32M80J			SOT-227
	0.11			57	APT53F80J	SOT-227
	0.10	60	APT58M80J			SOT-227

Part numbers for D3PAK packages—replace “B” with “S” in part number.
 Part numbers for TO-264 packages—replace “B2” with “L” in part number.

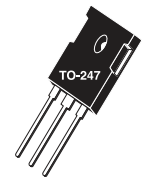

TO-247[B]



TO-220[K]



D3PAK[S]

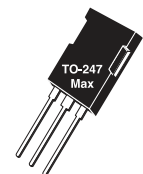

T-MAX®[B2]

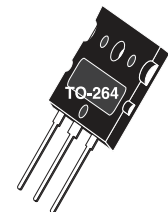

TO-264[L]

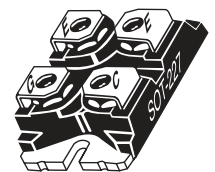

SOT-227[J]
(Isolated Base)

BV _{DSS} (V)	R _{Ds(ON)} Max (Ω)	I _D (A)	MOSFET Part Number	I _D (A)	FREDFET Part Number	Package Style
600	0.37			19	APT18F60B	TO-247 or D3PAK
	0.29			24	APT23F60B	TO-247 or D3PAK
	0.19	36	APT34M60B	36	APT34F60B	TO-247
	0.15	45	APT43M60B2	45	APT43F60B2	T-MAX® or TO-264
	0.15	31	APT30M60J	31	APT30F60J	SOT-227
	0.11	60	APT56M60B2	60	APT56F60B2	T-MAX or TO-264
	0.11	42	APT39M60J	42	APT39F60J	SOT-227
	0.09	70	APT66M60B2	70	APT66F60B2	T-MAX or TO-264
	0.09	49	APT47M60J	49	APT47F60J	SOT-227
	0.055	84	APT80M60J	84	APT80F60J	SOT-227
500	0.24			24	APT24F50B	TO-247 or D3PAK
	0.19			30	APT30F50B	TO-247 or D3PAK
	0.15			37	APT37F50B	TO-247 or D3PAK
	0.13			43	APT42F50B	TO-247 or D3PAK
	0.10	56	APT56M50B2	56	APT56F50B2	T-MAX or TO-264
	0.10	38	APT38M50J	38	APT38F50J	SOT-227
	0.075	75	APT75M50B2	75	APT75F50B2	T-MAX or TO-264
	0.075	51	APT51M50J	51	APT51F50J	SOT-227
	0.062	84	APT84M50B2	84	APT84F50B2	T-MAX or TO-264
	0.062	58	APT58M50J	58	APT58F50J	SOT-227
	0.036	103	APT100M50J	103	APT100F50J	SOT-227

Part numbers for D3PAK packages—replace “B” with “S” in part number.
Part numbers for TO-264 packages—replace “B2” with “L” in part number.

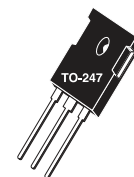

TO-247[B]



D3PAK[S]



T-MAX® [B2]

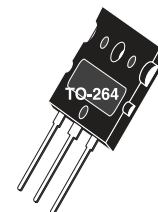

TO-264[L]

Low-Voltage Power MOS V[®] MOSFETs/FREDFETs

BV _{DSS} (V)	R _{Ds(ON)} Max (Ω)	I _D (A)	MOSFET Part Number	I _D (A)	FREDFET Part Number	Package Style
300	0.085	40	APT30M85BVRG			TO-247
	0.070	48	APT30M70BVRG	48	APT30M70BVFRG	TO-247 or D3PAK
	0.040	70	APT30M40JVR	70	APT30M40JVFR	SOT-227
	0.019	130	APT30M19JVR	130	APT30M19JVFR	SOT-227
200	0.045	56	APT20M45BVRG	56	APT20M45BVFRG	TO-247
	0.038	67	APT20M38BVRG			TO-247 or D3PAK
	0.022			100	APT20M22LVFRG	TO-264
	0.018	100	APT20M18B2VRG	100	APT20M18B2VFRG	T-MAX® or TO-264
	0.011	175	APT20M11JVR	175	APT20M11JVFR	SOT-227

Part numbers for D3PAK packages—replace “B” with “S” in part number.
Part numbers for TO-264 packages—replace “B2” with “L” in part number.

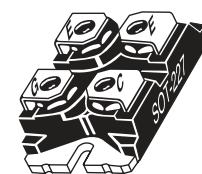

SOT-227[J]
(Isolated Base)

Ultra-Fast, Low Gate Charge MOSFETs



For 250 kHz–2 MHz Switching Applications

The ultra-fast, low gate charge MOSFET family combines the lowest gate charge available in the industry with Microchip's proprietary self-aligned aluminum metal gate structure. The result is a MOSFET capable of extremely fast switching speeds and very-low switching losses. The metal gate structure and the layout of these chips provide an internal Series Gate Resistance (EGR) an order of magnitude lower than competitive devices built with a polysilicon gate.

These devices are ideally suited for high-frequency and pulsed high-voltage applications.

Typical Applications

- Class D amplifiers up to 2 MHz
- High-voltage pulsed DC
- AM transmitters
- Plasma deposition/etch

Features

- Series gate resistance (R_g) $< 0.1 \Omega$
- T_r and T_f times of < 10 ns
- Industry's lowest gate charge

Benefits

- Fast switching, uniform signal propagation
- Pulse power applications
- Fast switching, reduced gate drive power

V_{DSS} (V)	$R_{DS(on)}$ Max (Ω)	I_D (A)	MOSFET Part Number	FREDFET Part Number	Package Style
1200	4.700	3.5		APT1204R7BFLLG	TO-247 or D3PAK
	1.400	9		APT1201R4BFLLG	TO-247
	0.570	22	APT12057B2LLG		T-MAX®
1000	0.900	12	APT10090BLLG		TO-247
	0.780	14	APT10078BLLG		TO-247 or D3PAK
	0.450	23	APT10045B2LLG		T-MAX or TO-264
	0.450	21	APT10045JLL		SOT-227
	0.370	25		APT10035JFLL	SOT-227
	0.370	28		APT10035B2FLLG	T-MAX
	0.350	28	APT10035LLLG		TO-264
	0.350	25	APT10035JLL		SOT-227
	0.260	38		APT10026L2FLLG	264-MAX™
	0.260	30	APT10026JLL	APT10026JFLL	SOT-227
	0.210	37	APT10021JLL	APT10021JFLL	SOT-227
800	0.260	29		APT8024JFLL	SOT-227
	0.240	29	APT8024JLL		SOT-227
	0.200	38	APT8020B2LLG	APT8020B2FLLG	T-MAX
	0.200	33	APT8020JLL		SOT-227 or D3PAK
	0.160	42		APT8014JFLL	SOT-227
	0.140	52	APT8014L2LLG	APT8014L2FLLG	264-MAX
	0.140	42	APT8014JLL		SOT-227
	0.110	51	APT8011JLL	APT8011JFLL	T-MAX or TO-264
500	0.140	35	APT5014BLLG		TO-247
	0.100	46	APT5010B2LLG	APT5010B2FLLG	T-MAX or TO-264
	0.075	51	APT50M75JLL	APT50M75JFLL	SOT-227
	0.075	57	APT50M75B2LLG		T-MAX or TO-264
	0.065	67	APT50M65LLLG	APT50M65B2FLLG	TO-264
	0.065	58	APT50M65JLL	APT50M65JFLL	SOT-227
	0.050	71	APT50M50JLL	APT50M50JFLL	SOT-227
	0.038	88	APT50M38JLL	APT50M38JFLL	SOT-227

Part numbers for D3PAK packages—replace “B” with “S” in part number.
Part numbers for TO-264 packages—replace “B2” with “L” in part number.

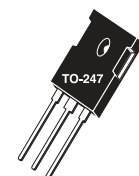

TO-247[B]

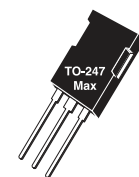

T-MAX®[B2]



SOT-227[J]
(Isolated Base)

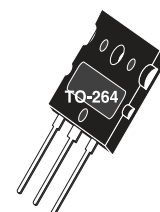

TO-264[L]



D3PAK[S]

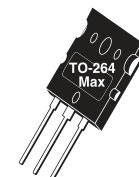

264-MAX™[L2]



Super Junction MOSFETs

V_{DS} (V)	$R_{DS(on)}$ (Ω)	$I_{D(Cont)}$ (A)	Part Number	Package Style	
C3 Technology					
800	0.450	11	APT11N80BC3G	TO-247	
	0.145	34	APT34N80B2C3G	T-MAX® or TO-264	
	0.145	34	APT34N80LC3G	TO-264	
600	0.070	47	APT47N60BC3G	TO-247 or D3PAK	
	0.035	77	APT77N60JC3	SOT-227	
	0.042	94	APT94N60L2C3G	264-MAX™	
Server Series					
600	0.045	60	APT60N60BCSG	TO-247 or D3PAK	
	C6 Technology				
	0.041	77	APT77N60BC6	TO-247 or D3PAK	
	0.070	53	APT53N60BC6	TO-247 or D3PAK	
	0.099	38	APT38N60BC6	TO-247 or D3PAK	
0.125	30	APT30N60BC6	TO-247 or D3PAK		
0.035	106	APT106N60B2C6	T-MAX or TO-264		

Part numbers for D3PAK packages—replace “B” with “S” in part number.
 Part numbers for TO-264 packages—replace “B2” with “L” in part number.

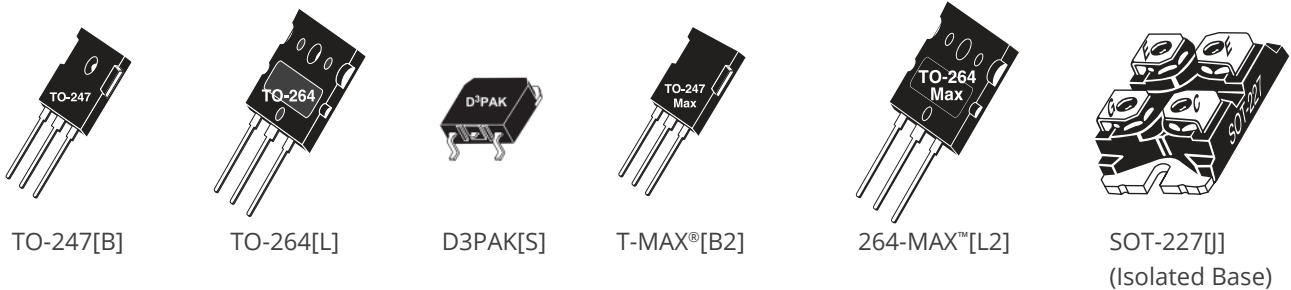



Linear MOSFETs

What is a Linear MOSFET?

A MOSFET specifically designed to be more robust than a standard MOSFET when operated with both high voltage and high current near DC conditions (>100 ms).

The Problem with SMPS MOSFETs

MOSFETs optimized for high-frequency SMPS applications have poor high voltage DC SOA. Most SMPS-type MOSFETs overstate SOA capability at high voltage on the datasheets. Above ~30V and DC conditions, SOA drops faster than is indicated by Power Dissipation (PD) limited operation. For pulsed loads ($t < 10$ ms), there is generally no problem using a standard MOSFET.

Technology Innovation

Introduced in 1999, Microchip modified its proprietary patented self-aligned metal gate MOSFET technology for enhanced performance in high voltage, linear applications. These linear MOSFETs typically provide 1.5–2.0 times the DC SOA capability at high voltage compared to other MOSFET technologies optimized for switching applications.

BV _{DSS} (V)	R _{ds(on)} (Ω)	I _{D(Cont)} (A)	SOA (W)	Part Number
600	0.125	49	325	APL602B2G
	0.125	43	325	APL602J
500	0.090	58	325	APL502B2G
	0.090	52	325	APL502J

Part numbers for TO-264 packages—replace “B2” with “L” in part number.

A Design Will Need Linear MOSFETs in the Following Situations

- High current and less than 200 volts at less than 100 milliseconds
- Used as a variable power resistor
- Soft start application (limit surge currents)
- Linear amplifier circuit

Typical Applications

- Active loads above 200 volts, such as DC dynamic loads for testing power supplies, batteries, fuel cells, etc.
- High voltage, high current, constant current sources



SOT-227[J]
(Isolated Base)

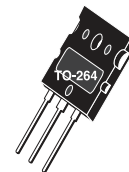

TO-264[L]



T-MAX® [B2]



IGBTs From Microchip

IGBT products from Microchip provide high-quality solutions for a wide range of high-voltage and high-power applications. The switching frequency range spans from DC for minimal conduction loss to 150 kHz for very-high-power-density Switch Mode Power Supply (SMPS) applications. The frequency range for each product type is shown in the following graph. Each IGBT product represents the latest in IGBT technology, providing the best possible performance/cost combination for the targeted application. There are six product series that utilize three different IGBT technologies: Non-Punch-Through (NPT), Punch-Through (PT) and field stop.

IGBT Switching Frequency Ranges (kHz, Hard Switched)

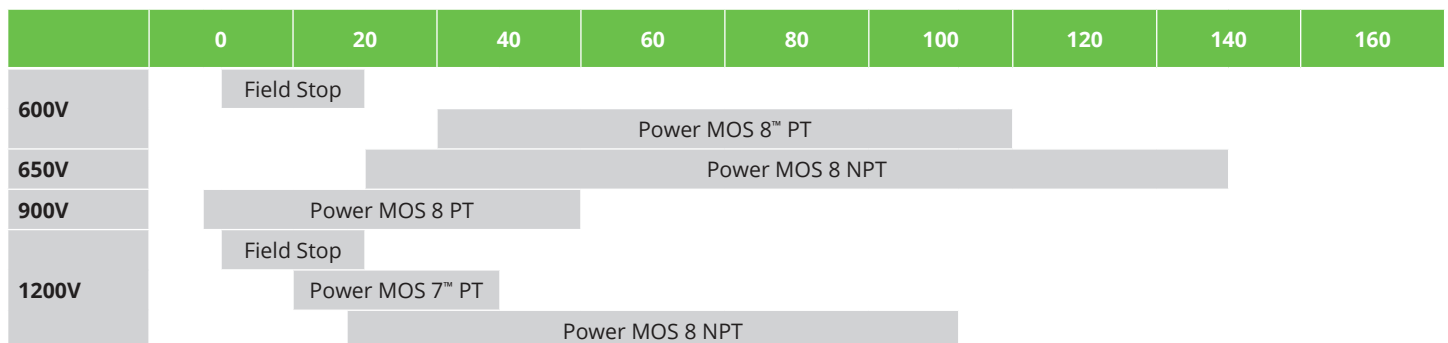



Note: Frequency ranges shown are typical for a 50 A IGBT. Refer to product datasheet maximum frequency versus current graph for more information.

Standard Series	Voltage Ratings (V)	Technology	Easy to Parallel	Short Circuit Safe Operating Area (SOA)	Parameter
MOS 7™	600, 900, 1200	PT			Ultra-low gate charge
MOS 8™	600, 650, 900, 1200	PT, NPT			Highest efficiency
Field Stop Trench Gate	600, 1200	Field Stop	•	•	Lowest conduction loss

Product Options

All standard IGBT products are available as a single IGBT or as a Combi product packaged with an anti-parallel DQ series diode. Package options include TO-220, TO-247, T-MAX®, TO-264 and SOT-227. Customized products are available; contact the factory for details.

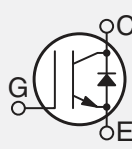
IGBTs—Punch-Through

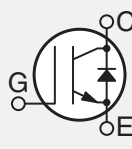
	$V_{(BR)CES}$ (V)	$V_{CE(ON)}$ (V) Typ 25°C	I_{c2} (A) 100°C	Maximum I_c (A) at Frequency		Part Number	Package Style		
				100 kHz	200 kHz				
POWER MOS 7™  <ul style="list-style-type: none"> • Ultra-low gate charge • Combi with high-speed DQ diode 	Single	600	2.2	27	19	12	APT15GP60BG	TO-247	
			2.2	49	37	24	APT30GP60BG	TO-247	
			2.2	62	41	26	APT40GP60BG	TO-247	
			2.2	40	25	16	APT40GP60J	SOT-227	
			2.2	72	41	26	APT50GP60BG	TO-247	
			2.2	46	26	19	APT50GP60J	SOT-227	
		2.2	100	72	45	APT80GP60B2G	T-MAX®		
		900			50 kHz	100 kHz			
			2.2	96	76	54	APT65GP60B2G	T-MAX	
			2.2	60	47	33	APT65GP60J	SOT-227	
			2.2	68	59	39	APT80GP60J	SOT-227	
			3.2	36	33	21	APT25GP90BG	TO-247	
	3.2		50	N/A	N/A	APT40GP90BG	TO-247		
	1200			20 kHz	40 kHz				
		3.2	32	N/A	N/A	APT40GP90J	SOT-227		
		3.3	33	19	12	APT25GP120BG	TO-247		
		3.3	46	24	15	APT35GP120BG	TO-247		
		3.3	54	29	18	APT45GP120BG	TO-247		
		3.3	34	28	18	APT45GP120J	SOT-227		
	Combi (IGBT & "DQ" FRED)  <ul style="list-style-type: none"> • Fast switching • Highest efficiency • Combi with high-speed DQ diode 	600			50 kHz	100 kHz			
			2.2	60	47	33	APT65GP60JDQ2	SOT-227	
			2.2	96	76	54	APT65GP60L2DQ2G	264-MAX®	
			2.2	68	59	39	APT80GP60JDQ3	SOT-227	
			2.2	68	59	39	APT80GP60JDQ3	SOT-227	
					100 kHz	200 kHz			
		900	2.2	27	19	12	APT15GP60BDQ1G	TO-247	
			2.2	49	37	24	APT30GP60BDQ1G	TO-247	
			2.2	62	41	26	APT40GP60B2DQ2G	TO-247	
			2.2	40	25	16	APT40GP60JDQ2	SOT-227	
			2.2	72	N/A	N/A	APT50GP60B2DQ2G	TO-247	
2.2			46	N/A	N/A	APT50GP60JDQ2	SOT-227		
1200			20 kHz	40 kHz					
	3.2	21	27	20	APT15GP90BDQ1G	TO-247			
	3.2	36	53	34	APT25GP90BDQ1G	TO-247			
	3.2	50	56	40	APT40GP90B2DQ2G	T-MAX			
	3.2	27	33	24	APT40GP90JDQ2	SOT-227			
	3.3	33	19	12	APT25GP120BDQ1G	TO-247			
600	3.3	46	24	15	APT35GP120B2DQ2G	T-MAX			
	3.3	54	29	18	APT45GP120B2DQ2G	T-MAX			
	3.3	34	28	18	APT45GP120JDQ2	SOT-227			
	3.3	57	40	23	APT75GP120JDQ3	SOT-227			
			50 kHz	80 kHz					
	POWER MOS 8™  <ul style="list-style-type: none"> • Fast switching • Highest efficiency • Combi with high-speed DQ diode 	600	2	36	21	17	APT36GA60B	TO-247 or D3PAK	
2			44	26	20	APT44GA60B	TO-247 or D3PAK		
2			47	N/A	N/A	APT47GA60JD40	SOT-227		
2			54	30	23	APT54GA60B	TO-247 or D3PAK		
2			68	35	27	APT68GA60B	TO-247 or D3PAK		
2			80	40	31	APT80GA60B	TO-247 or D3PAK		
900		2	102	51	39	APT102GA60B2	T-MAX or TO-264		
				25 kHz	50 kHz				
		2.5	35	17	10	APT35GA90B	TO-247 or D3PAK		
		2.5	43	21	13	APT43GA90B	TO-247 or D3PAK		
		2.5	64	29	19	APT64GA90B	TO-247 or D3PAK		
		2.5	80	34	23	APT80GA90B	TO-247 or D3PAK		
Combi (IGBT & "DQ" FRED)  <ul style="list-style-type: none"> • Fast switching • Highest efficiency • Combi with high-speed DQ diode 	600			50 kHz	80 kHz				
		2	36	21	17	APT36GA60BD15	TO-247 or D3PAK		
		2	44	26	20	APT44GA60BD30	TO-247 or D3PAK		
		2	54	30	23	APT54GA60BD30	TO-247 or D3PAK		
		2	60	48	36	APT60GA60JD60	SOT-227		
		2	68	35	27	APT68GA60B2D40	T-MAX or TO-264		
	900	2	80	40	31	APT80GA60LD40	TO-264		
				25 kHz	50 kHz				
		2.5	27	14	8	APT27GA90BD15	TO-247 or D3PAK		
		2.5	35	17	10	APT35GA90BD15	TO-247 or D3PAK		
		2.5	43	21	13	APT43GA90BD30	TO-247 or D3PAK		
		2.5	46	33	21	APT46GA90JD40	SOT-227		
600	2.5	64	29	19	APT64GA90B2D30	T-MAX or TO-264			
	2.5	80	34	23	APT80GA90LD40	TO-264			

Part numbers for D3PAK packages—replace "B" with "S" in part number.
 Part numbers for TO-264 packages—replace "B2" with "L" in part number.

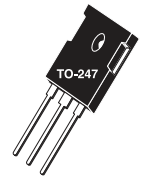

TO-247[B]



D3PAK[S]

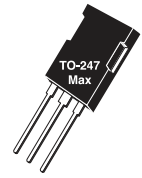

T-MAX®[B2]

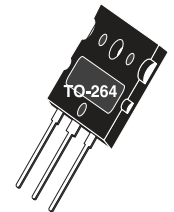

TO-264[L]

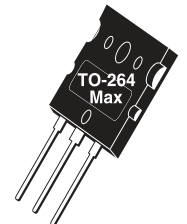

264-MAX™[L2]

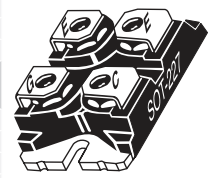

SOT-227[J]

IGBTs—Non-Punch-Thru

POWER MOS 8™

	$V_{(BR)CES}$ (V)	$V_{CE(ON)}$ (V) Typ 25°C	I_{c2} (A) 100°C	Maximum I_c (A) at Frequency		Part Number	Package Style				
				100 kHz	200 kHz						
 <ul style="list-style-type: none"> • High-speed switching • Low switching losses • Easy to parallel 	Single			100 kHz	200 kHz						
				650	1.9			45	31	25	APT45GR65B
	1.9	70	100 kHz			150 kHz	APT70GR65B		TO-247		
			1.9	95	52	39		APT95GR65B2		T-MAX®	
	1200	2.5			25	50 kHz	80 kHz	APT25GR120B	TO-247		
			25	21		APT25GR120S	D3PAK				
			40	28		APT40GR120B	TO-247				
			40	28		APT40GR120S	D3PAK				
			50	36		APT50GR120B2	T-MAX				
			50	36		APT50GR120L	TO-264				
			25 kHz	50 kHz		APT70GR120B2	T-MAX				
			66	42						APT70GR120L	TO-264
			70*	30						APT70GR120J	SOT-227
			85	46						APT85GR120B2	T-MAX
			85	46						APT85GR120L	TO-264
			85*	31						APT85GR120J	SOT-227
	1200	2.5	25	50 kHz	80 kHz	APT25GR120BD15	TO-247				
				25	21			APT25GR120SD15	D3PAK		
40				28	APT40GR120B2D30			T-MAX			
25 kHz				50 kHz	APT50GR120JD30			SOT-227			
50*				32							
70*				30					APT70GR120JD60	SOT-227	
85*				31					APT85GR120JD60	SOT-227	

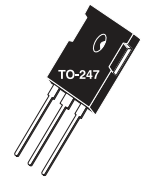

TO-247[B]



D3PAK[S]

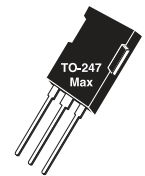

T-MAX®[B2]

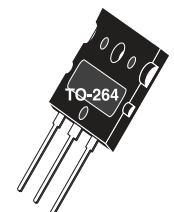

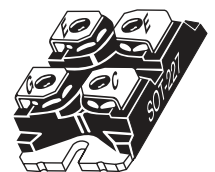

TO-264[L]



SOT-227[J]

Current at frequency test conditions: $T_j = 125^\circ\text{C}$, $T_c = 100^\circ\text{C}$ except SOT-227 where $T_c = 80^\circ\text{C}$, $V_{cc} = 67\%$ rated voltage hard switch.

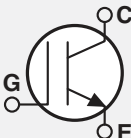
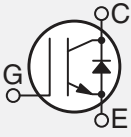
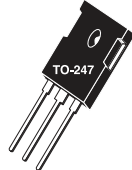
IGBTs—Field Stop

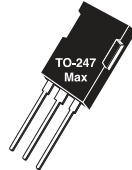
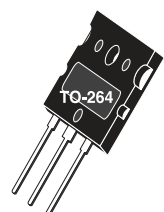
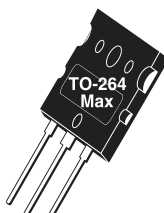
Field Stop	Single	$V_{(BR)CES}$ (V)	$V_{CE(ON)}$ (V) Typ 25°C	I_{c2} (A) 100°C	Maximum I_c (A) at Frequency		Part Number	Package Style			
					15 kHz	30 kHz					
 <ul style="list-style-type: none"> Trench technology Short circuit rated Lowest conduction loss Easy paralleling Combi with high-speed DQ diode 	600	1.5	24	15	10	APT20GN60BG	TO-247	 TO-247[B]			
		1.5	37	20	14	APT30GN60BG	TO-247				
		1.5	64	30	21	APT50GN60BG	TO-247				
		1.5	93	42	30	APT75GN60BG	TO-247				
		1.5	123	75	47	APT150GN60J	SOT-227				
		1.5	135	54	39	APT100GN60B2G	T-MAX®		 D3PAK[S]		
		1.5	190	79	57	APT150GN60B2G	T-MAX				
		1.5	230	103	75	APT200GN60B2G	T-MAX				
	1.5	158	100	66	APT200GN60J	SOT-227					
	1200				10 kHz	20 kHz			 T-MAX®[B2]		
		1.7	33	19	13	APT25GN120BG	TO-247 or D3PAK				
		1.7	46	24	17	APT35GN120BG	TO-247				
		1.7	66	32	22	APT50GN120B2G	T-MAX				
		1.7	70	44	27	APT100GN120J	SOT-227				
		1.7	99	45	30	APT75GN120B2G	T-MAX or TO-264				
		1.7	120	58	38	APT100GN120B2G	T-MAX				
		1.7	99	60	36	APT150GN120J	SOT-227				
	600	Combi (IGBT & "DQ" FRED)			15 kHz	30 kHz			 TO-264[L]		
			1.5	24	15	10	APT20GN60BDQ1G	TO-247			
		1.5	37	20	14	APT30GN60BDQ2G	TO-247				
		1.5	64	30	21	APT50GN60BDQ2G	TO-247				
		1.5	93	42	30	APT75GN60LDQ3G	TO-264				
		1.5	123	75	47	APT150GN60JDQ4	SOT-227				
		1.5	135	54	39	APT100GN60LDQ4G	TO-264				
		1.5	190	79	57	APT150GN60LDQ4G	TO-264				
		1.5	158	100	66	APT200GN60JDQ4	SOT-227				
		1200				10 kHz	20 kHz				 264-MAX™[L2]
			1.7	22	14	10	APT15GN120BDQ1G	TO-247 or D3PAK			
1.7			33	19	13	APT25GN120B2DQ2G	T-MAX				
1.7			46	24	17	APT35GN120L2DQ2G	264-MAX™				
1.7			57	36	22	APT75GN120JDQ3	SOT-227				
1.7			66	32	22	APT50GN120L2DQ2G	264-MAX				
1.7			70	44	27	APT100GN120JDQ4	SOT-227				
1.7	99		60	36	APT150GN120JDQ4	SOT-227					

Part numbers for D3PAK packages—replace "B" with "S" in part number.
 Part numbers for TO-264 packages—replace "B2" with "L" in part number.

Current at frequency test conditions: $T_j = 125^\circ\text{C}$, $T_c = 100^\circ\text{C}$ except SOT-227 where $T_c = 80^\circ\text{C}$, $V_{cc} = 67\%$ rated voltage hard switch.



Schottky Barrier Diodes, Fast and Ultra-Fast Recovery Diodes

Microchip offers four series of discrete diode products: the medium-speed medium V_f D series, the high-speed DQ series, the silicon Schottky S series and the SiC Schottky Barrier Diode series. These series of diodes are designed to provide high-quality solutions to a wide range of high-voltage, high-power application requirements, ranging from fast recovery for continuous conduction mode power factor correction to low conduction loss for output rectification. The following table summarizes each product family's distinguishing features and potential applications.

The following graph shows the relative recovery speed and forward voltage positions of D, DQ, and SiC series diodes.

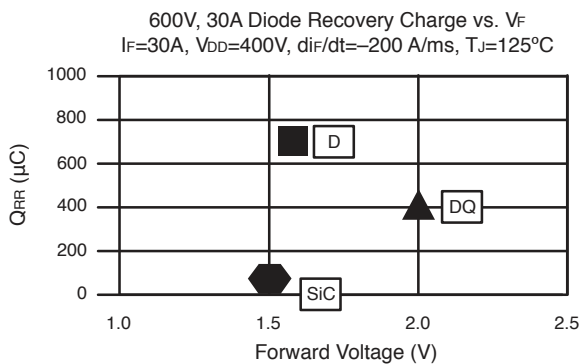

















Fast, Ultra-Fast and Schottky Diodes

Series	Voltage Ratings	Features	Applications	Comment
D	200, 300, 400, 600, 1000, 1200	Medium V_f Medium speed	Freewheeling diode Output rectifier DC-DC converter	Proprietary platinum process
DQ	600, 1000, 1200	High speed Avalanche rated	PFC Freewheeling diode DC-DC converter	Stepped EPI improves softness Proprietary platinum process
Schottky	200	Low V_f Avalanche rated	Output rectifier Freewheeling diode DC-DC converter	
SiC Schottky	700, 1200, 1700, 3300	Zero reverse recovery	PFC Freewheeling diode DC-DC converter	Low switching losses, high power density and high-temperature operation



SiC Schottky Barrier Diode (SBD) Devices

Part Number	Voltage (V)	I _F (A)	Package
MSC010SDA070B 	700	10	TO-247
MSC010SDA070K 		10	TO-220
MSC030SDA070B 		30	TO-247
MSC030SDA070K 		30	TO-220
MSC050SDA070B 		50	TO-247
MSC010SDA120B 	1200	10	TO-247
MSC010SDA120K 		10	TO-220
MSC015SDA120B 		15	TO-247
MSC015SDA120K 		15	TO-220
MSC020SDA120B 		20	TO-247
MSC020SDA120K 		20	TO-220
MSC020SDA120S 		20	D3PAK
MSC030SDA120B 		30	TO-247
MSC030SDA120K 		30	TO-220
MSC030SDA120S 		30	D3PAK
MSC050SDA120B 		50	TO-247
MSC050SDA120S 		50	D3PAK
MSC010SDA170B		1700	10
MSC030SDA170B	30		TO-247
MSC050SDA170B	50		TO-247
MSC030SDA330B	3300	30	TO-247
MSC090SDA330B2		90	T-MAX®
MSC030SDA070BCT	700 Dual Diode (Common Cathode)	2 × 30	TO-247
MSC050SDA070BCT		2 × 50	TO-247
MSC030SDA120BCT	1200 Dual Diode (Common Cathode)	2 × 30	TO-247
MSC050SDA120BCT		2 × 50	TO-247
MSC2X30/31SDA070J	700 Dual Diode (Anti-parallel/parallel)	2 × 30	SOT-227
MSC2X50/51SDA070J		2 × 50	SOT-227
MSC2X100/101SDA070J		2 × 100	SOT-227
MSC2X30/31SDA120J	1200 Dual Diode (Anti-parallel/parallel)	2 × 30	SOT-227
MSC2X50/51SDA120J		2 × 50	SOT-227
MSC2X100/101SDA120J		2 × 100	SOT-227



D3PAK[S]

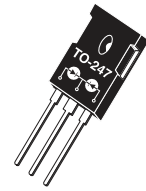

TO-247[BCT]
Common cathode

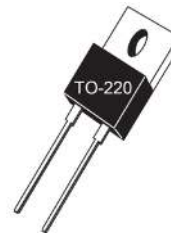

TO-220[K]

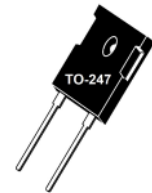

TO-247-2L[B]



SOT-227[J]
Antiparallel
Configuration
(Isolated Base)

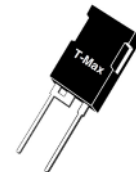

T-MAX®[B2]

 Auto-Qualified Part

Si Schottky Barrier Diodes, Fast and Ultra-Fast Recovery Diodes

Volts	I (A)	Forward Voltage Typ 25°C	t(ns) Typ 25°C	Qrr (nC) Typ 125°C at I _F = I _F (avg)	Diode Series	Part Number	Package
Single							
1200	15	2.8	21	960	DQ	APT15DQ120BG	TO-247
	15	2.8	21	960	DQ	APT15DQ120KG	TO-220
	15	2.0	32	1300	D	APT15D120BG	TO-247
	15	2.0	32	1300	D	APT15D120KG	TO-220
	30	2.8	24	1800	DQ	APT30DQ120BG	TO-247
	30	2.8	24	1800	DQ	APT30DQ120KG	TO-220
	30	2.0	31	3450	D	APT30D120BG	TO-247
	40	2.8	26	2200	DQ	APT40DQ120BG	TO-247
	60	2.8	30	2800	DQ	APT60DQ120BG	TO-247
	60	2.0	38	4000	D	APT60D120BG	TO-247 or D3PAK
75	2.8	32	3340	DQ	APT75DQ120BG	TO-247	
1000	15	2.5	20	810	DQ	APT15DQ100BG	TO-247
	15	2.5	20	810	DQ	APT15DQ100KG	TO-220
	15	1.9	28	1550	D	APT15D100BG	TO-247
	15	1.9	28	1550	D	APT15D100KG	TO-220
	30	2.5	22	1250	DQ	APT30DQ100BG	TO-247
	30	2.5	22	1250	DQ	APT30DQ100KG	TO-247
	30	1.9	29	2350	D	APT30D100BG	TO-247
	40	2.5	24	1430	DQ	APT40DQ100BG	TO-247
	60	2.5	29	2325	DQ	APT60DQ100BG	TO-247
	60	1.9	34	3600	D	APT60D100BG	TO-247 or D3PAK
75	2.5	33	2660	DQ	APT75DQ100BG	TO-247	
600	15	2.0	16	250	DQ	APT15DQ60BG	TO-247
	15	2.0	16	250	DQ	APT15DQ60KG	TO-220
	15	1.6	21	520	D	APT15D60BG	TO-247
	15	1.6	21	520	D	APT15D60KG	TO-220
	30	2.0	19	400	DQ	APT30DQ60BG	TO-247
	30	2.0	19	400	DQ	APT30DQ60KG	TO-220
	30	1.6	23	700	D	APT30D60BG	TO-247
	40	2.0	22	480	DQ	APT40DQ60BG	TO-247
	60	2.0	26	640	DQ	APT60DQ60BG	TO-247
	60	1.6	40	920	D	APT60D60BG	TO-247 or D3PAK
75	2.0	29	650	DQ	APT75DQ60BG	TO-247	
400	15	1.3	19	300	D	APT15D40KG	TO-220
	30	1.3	22	360	D	APT30D40BG	TO-247
	60	1.3	30	540	D	APT60D40BG	TO-247
200	30	1.1	21	150	D	APT30D20BG	TO-247
	30	0.83	25	448	Schottky	APT30S20BG	TO-247 or D3PAK
	60	1.1	30	250	D	APT60D20BG	TO-247
	60	0.83	35	490	Schottky	APT60S20BG	TO-247 or D3PAK
	100	0.89	40	690	Schottky	APT100S20BG	TO-247

Part numbers for D3PAK—replace “B” with “S” in part number.

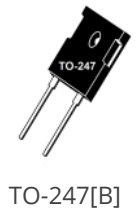

Si Schottky Barrier Diodes, Fast and Ultra-Fast Recovery Diodes

Volts	I (A)	Forward Voltage Typ 25°C	t(ns) Typ 25°C	Qrr (nC) Typ 125°C at I _r = I _f (avg)	Diode Series	Part Number	Package
Dual							
1200	2x27	2	31	3450	D	APT2X30D120J	SOT-227
	2x30	2.6	25	1800	DQ	APT2X30DQ120J	SOT-227
	2x53	2.0	38	4000	D	APT2X60D120J	SOT-227
	2x60	2.5	30	2890	DQ	APT2X60DQ120J	SOT-227
	2x93	2.0	47	5350	D	APT2X100D120J	SOT-227
1000	2x100	2.4	45	5240	DQ	APT2X100DQ120J	SOT-227
	2x28	1.9	29	2350	D	APT2X30D100J	SOT-227
	2x55	1.9	34	3600	D	APT2X60D100J	SOT-227
	2x60	2.2	30	2350	DQ	APT2X60DQ100J	SOT-227
	2x95	1.9	43	4050	D	APT2X100D100J	SOT-227
600	2x100	2.1	45	3645	DQ	APT2X100DQ100J	SOT-227
	2x30	1.8	20	400	DQ	APT2X30DQ60J	SOT-227
	2x30	1.6	23	700	D	APT2X30D60J	SOT-227
	2x60	1.7	27	650	DQ	APT2X60DQ60J	SOT-227
	2x60	1.6	40	920	D	APT2X60D60J	SOT-227
400	2x100	1.6	30	980	DQ	APT2X100DQ60J	SOT-227
	2x100	1.6	34	1450	D	APT2X100D60J	SOT-227
	2x30	1.3	22	360	D	APT2X30D40J	SOT-227
	2x60	1.3	30	540	D	APT2X60D40J	SOT-227
	2x100	1.3	37	1050	D	APT2X100D40J	SOT-227
300	2x30	1.2	20	150	D	APT2X30D30J	SOT-227
	2x60	1.2	29	370	D	APT2X61D30J	SOT-227
	2x100	1.2	36	650	D	APT2X101D30J	SOT-227
200	2x30	1.1	21	150	D	APT2X30D20J	SOT-227
	2x60	1.1	30	250	D	APT2X61D20J	SOT-227
	2x30	0.80	25	448	Schottky	APT2X31S20J	SOT-227
	2x60	0.83	35	490	Schottky	APT2X61S20J	SOT-227
	2x100	1.1	39	840	D	APT2X100D20J	SOT-227
1200	2x100	0.89	40	690	Schottky	APT2X101S20J	SOT-227
	2x30	2.8	26	2100	DQ	APT30DQ120BCTG	TO-247 [BCT]
	2x15	2.5	20	810	DQ	APT15DQ100BCTG	TO-247 [BCT]
	2x15	1.9	28	1550	D	APT15D100BCTG	TO-247 [BCT]
	2x15	1.9	28	1550	D	APT15D100BHBG	TO-247 [BHB]
1000	2x18	1.9	29	2350	D	APT30D100BCAG	TO-247 [BCA]
	2x30	1.9	29	2360	D	APT30D100BCTG	TO-247 [BCT]
	2x30	1.9	30	2350	D	APT30D100BHBG	TO-247 [BHB]
	2x40	2.5	25	1650	DQ	APT40DQ100BCTG	TO-247 [BCT]
	2x60	2.5	29	2325	DQ	APT60DQ100LCTG	TO-264 [LCT]
600	2x60	1.9	35	3600	D	APT60D100LCTG	TO-264 [LCT]
	2x15	1.6	21	520	D	APT15D60BCTG	TO-247 [BCT]
	2x15	2.0	15	250	DQ	APT15DQ60BCTG	TO-247 [BCT]
	2x15	1.6	20	520	D	APT15D60BCAG	TO-247 [BCA]
	2x30	2.0	22	480	DQ	APT30DQ60BHBG	TO-247 [BHB]
	2x30	2.0	19	400	DQ	APT30DQ60BCTG	TO-247 [BCT]
	2x30	1.6	23	700	D	APT30D60BCTG	TO-247 [BCT]
	2x30	1.6	25	700	D	APT30D60BHBG	TO-247 [BHB]
	2x30	1.6	25	700	D	APT30D60BCAG	TO-247 [BCA]
	2x40	2.0	22	480	DQ	APT40DQ60BCTG	TO-247 [BCT]
400	2x60	2.0	26	640	DQ	APT60DQ60BCTG	TO-247 [BCT]
	2x60	1.6	30	920	D	APT60D60LCTG	TO-264 [LCT]
	2x15	1.3	19	300	D	APT15D40BCTG	TO-247 [BCT]
	2x30	1.3	22	360	D	APT30D40BCTG	TO-247 [BCT]
	2x60	1.3	30	540	D	APT60D40LCTG	TO-264 [LCT]
300	2x30	1.2	25	1300	D	APT30D30BCTG	TO-247 [BCT]
	2x30	1.1	21	150	D	APT30D20BCTG	TO-247 [BCT]
	2x30	1.1	21	150	D	APT30D20BCAG	TO-247 [BCA]
200	2x30	0.80	25	448	Schottky	APT30S20BCTG	TO-247 [BCT]
	2x60	0.83	35	490	Schottky	APT60S20B2CTG	T-MAX® [B2CT]
	2x100	0.89	40	690	Schottky	APT100S20LCTG	TO-264 [LCT]

Part numbers for parallel configuration: replace 30, 60, or 100 with 31, 61, or 101, unless Schottky.
Example: 2X30D120J becomes 2X31D120J.

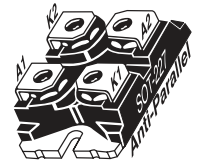

SOT-227[J]
Antiparallel
Configuration
(Isolated Base)

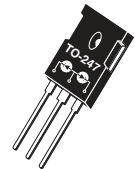
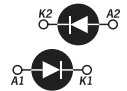

TO-247[BCA]
Common anode

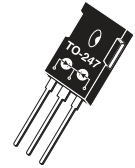

TO-247[BCT]
Common cathode

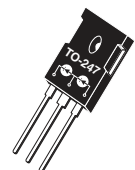

TO-247[BHB]
Half-bridge

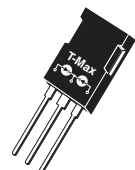

T-MAX® [B2CT]
Common cathode

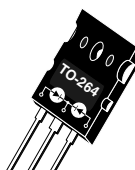

TO-264[LCT]
Common cathode



High-Voltage RF MOSFETs

The ARF family of RF power MOSFETs is optimized for applications requiring frequencies as high as 150 MHz and operating voltages as high as 400V. Historically, RF power MOSFETs were limited to applications of 50V or less. This limitation has been removed by combining Microchip's high-voltage MOSFET technology with RF-specific die geometries.

Higher V_{DD} means higher load impedance. For 150W output from a 50V supply, the load impedance is only 8 Ω . At 125V,

the load impedance is 50 Ω . The higher impedance allows simpler transformers and combiners. Paralleled devices can still operate into reasonable and convenient impedances. The increased operating voltage also lowers the DC current required for any given power output, increasing efficiency and reducing the size, weight and cost of other system components. High breakdown voltage is a necessity in high-efficiency switchmode amplifiers, such as class C-E, which can see peak drain voltages of over 4x the applied V_{DD} .

Part Number	P _{out} (W)	Freq. (MHz)	V _{DD} /B _V DSS (V)	R _{thjc} (°C/W)	Package Style	Class of Operation
ARF449AG/BG	90	120	150/450	0.76	TO-247	A-E
ARF463AG/BG	100	100	125/500	0.7	TO-247	A-E
ARF463AP1G/BP1G	100	100	125/500	0.7	TO-247	A-E
ARF460AG/BG	150	65	125/500	0.5	TO-247	A-E
ARF461AG/BG	150	65	250/1000	0.5	TO-247	A-E
ARF465AG/BG	150	60	300/1200	0.5	TO-247	A-E
ARF468AG/BG	300	45	150/500	0.35	TO-264	A-E
ARF475FL	450	150	165/500	0.17	T3A	A-E
ARF476FL	300	150	165/500	0.31	T3	A-E
ARF466AG/BG	300	45	200/1000	0.35	TO-264	A-E
ARF466FL	300	45	200/1000	0.13	T3A	A-E
ARF469AG/BG	350	45	165/500	0.28	TO-264	A-E
ARF477FL	400	100	165/500	0.20	T3A	A-E
ARF1500	750	40	125/500	0.10	T1	A-E
ARF1501	750	40	250/1000	0.10	T1	A-E
ARF1510	750	40	400/1000	0.10	T1	D
ARF1511	750	40	380/500	0.10	T1	D
ARF1519	750	25	250/1000	0.13	T2	A-E

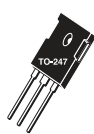

TO-247

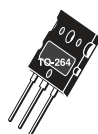

TO-264



T1

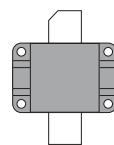

T2

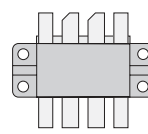

T3

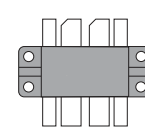

T3A



High-Frequency RF MOSFETs

The VRF family of RF MOSFETs includes improved replacements for industry-standard RF transistors. They provide improved ruggedness by increasing the B_{VDS} over 30 percent from the industry-standard 125V to 170V minimum. Low-cost flangeless packages are another improvement that shows

Microchip's dedication to optimizing performance, reducing cost and improving reliability. We will continue to offer more products with the new reduced-cost flangeless packages.

Part Number	P_{OUT} (W)	Freq. (MHz)	Gain Typ (dB)	Eff. Typ (%)	V_{DD}/B_{VDS} (V)	R_{thJC} ($^{\circ}C/W$)	Package Style
VRF141	150	175	13	45	28/80	0.60	M174
VRF151	150	175	14	50	20/170	0.60	M174
VRF152	150	175	14	50	50/130	0.60	M174
VRF150	150	150	11	50	50/170	0.60	M174
VRF161	200	150	14	50	50/170	0.50	M177
VRF141G	300	175	14	55	28/80	0.35	M208
VRF151G	300	175	16	55	50/170	0.35	M208
VRF2933	300	150	22	50	50/170	0.27	M177
VRF2944	400	150	25	50	65/170	0.22	M177
VRF154FL	600	30	17	45	50/170	0.13	T2
VRF157FL	600	30	21	45	50/170	0.13	T2
VRF164FL	600	30	21	45	65/170	0.10	T2

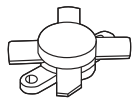

M113/M174/
M177

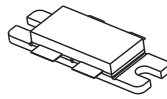

M208

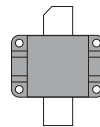

T2

Drivers and Driver-RF MOSFET Hybrids

The DRF1200/01 hybrids integrate drivers, bypass capacitors and RF MOSFETs into a single package. Integration maximizes amplifier performance by minimizing transmission line parasitics between the driver and the MOSFET. The DRF1300 and DRF1301 have two independent channels, each containing a driver and RF MOSFET in a push-pull configuration. The DRF1400 is a half-bridge hybrid with symmetrically oriented

leads that can be easily configured into a full-bridge converter. The DRF1510 is a full bridge product optimized for maximum efficiency in class D amplifiers. All DRF parts feature a proprietary anti-ring function to eliminate cross conduction in bridge or push-pull topologies. All DRF parts can be externally selected in either an inverting or non-inverting configuration.

Part Number	Pout (W)	Freq. (MHz)	V _{DD} /B _{VDDSS} (V)	Package Style	Class of Operation
DRF1200	600	30	15/1000	T2B	D-E
DRF1201	1000	30	15/1000	T2B	D-E
DRF1300	1000	30	15/500	T4	D-E
DRF1301	1000	30	15/1000	T4	D-E
DRF1400	1000	30	15/500	T4	D-E
DRF1211	1000	30	15/1000	T2B	D-E
DRF1311	1000	30	15/1000	T4	D-E
DRF1410	1000	30	15/500	T4A	D-E
DRF1510	2000	30	15/500	T5	D-E

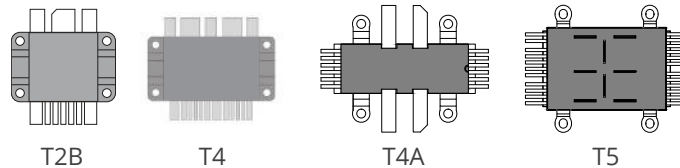

RF Reference Designs

[DRF1200/CLASS-E, 13.56 MHz](#) [DRF1200/CLASS-E, 27.12 MHz](#)

The DRF1200/Class-E single-ended RF generator is a reference design that allows the designer to evaluate an 85 percent efficient 1000W Class-E RF generator.

[DRF1300/CLASS-D, 13.56 MHz](#)

The DRF1300/Class-D push-pull RF generator is a reference design that allows the designer to evaluate an 80-percent efficient 2000W Class-D RF generator.

[DRF1400/Class-D, 13.56 MHz](#)

The DRF1400/Class-D half-bridge RF generator is a reference design that allows the designer to evaluate an 85-percent efficient 2500W Class-D RF generator.

Reference Design Kits

All kits include a fully populated board attached to an aluminum heat sink, an extensive application note explaining the theory of operation with designer's recommendations for evaluation and board layout, and all key waveforms illustrated and described. A complete parts list with recommended vendor part numbers and the board's Gerber file are provided for an easy transition into an end application.

[DRF1200/CLASS-E, 13.56 MHz and DRF1200/CLASS-E, 27.12 MHz](#)

The DRF1200/Class-E single-ended RF generator is a reference design that allows the designer to evaluate an 85 percent efficient 1000W Class-E RF generator.

[DRF1300/CLASS-D, 13.56 MHz](#)

The DRF1300/Class-D push-pull RF generator is a reference design that allows the designer to evaluate an 80-percent efficient 2000W Class-D RF generator.

[DRF1400/Class-D, 13.56 MHz](#)

The DRF1400/Class-D half-bridge RF generator is a reference design that allows the designer to evaluate an 85-percent efficient 2500W Class-D RF generator.

Power Modules Contents



Microchip combines a formidable array of technologies in semiconductors, packaging and automated manufacturing to produce a wide range of high-quality modules optimized for the following traits:

- Reliability
- Efficiency and electrical performance
- Low cost
- Space savings
- Reduced assembly time

The readily available standard module product line spans a wide selection of semiconductor (including Silicon Carbide) circuit topologies, voltage and current ratings, and packages. If you need even more flexibility or intellectual property protection, we can customize a standard module with a low setup cost and short lead time. Unique requirements can be met with Application Specific Power Modules (ASPM).

Microchip serves a broad spectrum of industrial applications for welding, solar, induction heating, medical, UPS, motor control and SMPS markets as well as high-reliability applications for semicap, defense and aerospace markets. A wide selection of construction materials enables Microchip to manufacture modules with the following features:

- Extended temperature range: -60°C to 200°C
- High-reliability
- Reduced size and weight
- High-reliability testing and screening options
- Short lead times

Microchip's experience and expertise in power electronic conversion brings the most effective technical support for your new development.

- Isolated gate driver
- Snubbers
- Mix-and-match semiconductors
- Short-circuit protection
- Temperature and current sensing
- Parameter binning

Standard Electrical Configurations

Microchip offers a wide range of standard electrical configurations housed in a variety of packages to match your specific needs for high power-density and performance. Various semiconductor types are offered in the same topology.

Electrical Topology	IGBT 600V-1700V	MOSFET 75V-1200V	Diode 200V-1700V	Mix Si-SiC 600V-1200V	Full SiC 600V-1700V	Digital Gate Driver
Asymmetrical bridge	•	•				
Boost buck	•	•				
Boost and buck chopper	•	•		•	•	•
Common anode			•			
Common cathode			•			
Dual boost and buck chopper	•	•		•		
Dual common source	•	•				
Dual diode					•	
Full bridge	•	•	•		•	•
Full bridge with PFC	•	•		•		
Full bridge with secondary fast rectifier bridge	•	•		•		
Full bridge with series and parallel diodes		•		•		
Interleaved PFC	•	•				
Linear single and dual switch		•				
Phase leg	•	•	•		•	•
Phase leg intelligent	•					
Phase leg with PFC		•		•		
Phase leg with series and parallel diodes		•		•		
Single switch	•	•	•			
Single switch with series and parallel diodes		•		•		
Single switch with series diodes	•	•				
3-Level NPC inverter	•				•	•
3-Level T-Type inverter	•			•	•	•
3-Phase bridge	•		•			
Triple dual common source	•	•				
Triple phase leg	•	•		•	•	•
	Trench3	MOSFET	FRED	IGBT	Diode	Gate Driver Core
	Trench4	FREDFET	Std Rectifier	MOSFET	MOSFET	Module Adapter Board
	Trench4 Fast	Super Junction MOSFET		Diode		Plug and Play Driver
	Trench5					Developer Kit

Package Advantages

SP1 package

- Replaces two SOT-227 parts
- Improved assembly time and cost
- Height compatible with SOT-227
- Copper base plate

SP3F package

- Replaces up to four SOT-227 parts
- Reduced assembly time and cost
- Height compatible with SOT-227
- Copper base plate

SP6 package

- Offers the same footprint and the same pinout location as the popular 62 mm package but with lower height, giving it the following advantages:
 - Reduced stray inductance
 - Reduced parasitic resistance
 - Higher efficiency at high frequency

SP6-P package

- Replaces up to six SOT-227 parts
- Height compatible with SOT-227
- Low-inductance solder pins
- High current capability

Improved Low-Profile Packages



SP1 (12 mm)



SP3F (12 mm)

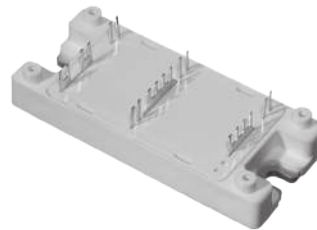

SP4 (17 mm)



D1P (17 mm)



SP6 (17 mm)



SP6-P (12 mm)



SP6LI (17 mm)

Industry-Standard Packages



SOT-227



D3 (62 mm wide)



D4 (62 mm wide)

High Reliability Baseless Packages



BL1 (9.3 mm)



BL2 (9.3 mm)



BL3 (9.3 mm)

Custom Power Modules

Microchip created the Active-state power management (ASPM) concept, and has been offering customized power modules since 1983. We offer a complete engineered solution with mix-and-match capabilities in term of package, configuration, performance and cost.

Internal Printed Circuit Board

- Not available in all modules
- Used to route gate signals' tracks to small signal terminals
- Used to mount gate circuit and protection in case of intelligent power module

Terminals

- Screw-on or solder pins
- Provides power and signal connections with minimum parasitic resistance and inductance

Substrates

- Al₂O₃, AlN, and Si₃N₄ provide isolation and good heat transfer to the base plate

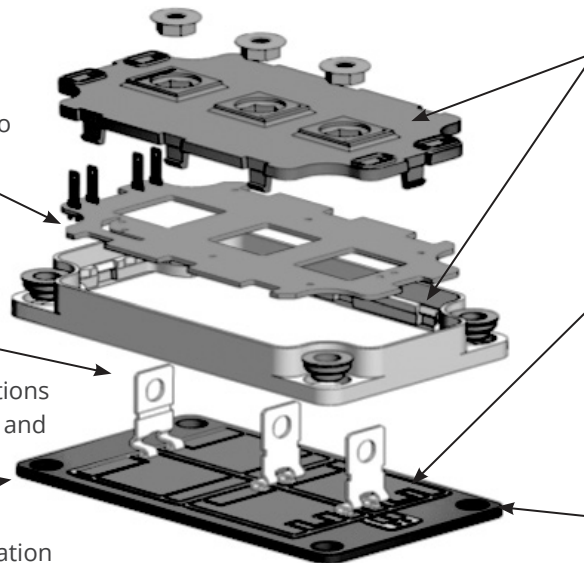

Package

- Standard or custom
- Ensures environmental protection and mechanical robustness

Power Semiconductor Die

- IGBT, MOSFET, diode, SiC, thyristor and switching devices soldered to the substrates and connected by ultrasonic aluminum wire bonds

Base Plate

- Improves the heat transfer to the heat sink
- Copper for good thermal transfer
- AlSiC, CuW and CuMoCu for improved reliability

Rugged Custom Versions (Available on Demand):

The standard power module products listed in this catalog are dedicated to industrial applications.

For more severe environmental conditions/requirements, we can propose rugged custom versions (derived from the existing standard products) using specific materials, including Aerospace-grade versions managed under AS9100 Quality Standards, with:

- AlSiC baseplate (instead of copper) for about (6x) higher power cycling capabilities
- Si₃N₄ AMB substrates or AlN DBC substrates (instead of Al₂O₃) for (20%) improved thermal conductivity
- Extended temperature raw materials to address wider temperature range applications (from -60°C Storage ; -55°C to +125°C Operating)

Easy Mounting Solutions With Press-Fit Versions (Available on Demand):

To facilitate the design, the assembly, and repair of your systems, our SP1F and SP3F package type products can be available with Press-Fit terminals.

SiC MOSFET Modules Without Parallel SiC Diodes (Available on Demand):

If applicable with your application (for cost saving), the SiC MOSFET products featuring a parallel SiC diode, listed in this catalog, can be available without.

Custom Power Modules

The following table shows the three customization levels.

Change Options:	Die	Substrate	Base Plate	Plastic Lid	Terminals	NRE Level	MOQ
Electrical/thermal performance	Die P/N	Material	Material			None to low	5 to 10 pieces
Electrical/thermal performance and electrical configuration	Die P/N	Material and layout	Material			Low to medium	
Electrical/thermal performance, and electrical configuration, and module housing	Die P/N	Material and layout	Material and shape	Material and shape	Shape	Medium to high	

Microchip power modules are made of different sub-elements. Most of them are standard and can be reused to build infinite solutions for the end user. Microchip offers optimum development cost and cycle time thanks to long-term experience and a wide range of available technologies.

Power Modules Features

- High power density
- Isolated and highly thermally-conductive substrate
- Internal wiring
- Minimum parasitics
- Minimum output terminals
- Mix-and-match components
- Fully engineered solutions

Customer Benefits

- Size and cost reduction
- Excellent thermal management
- Reduced external hardware
- Improved performance
- Reduced assembly time
- Optimizes losses
- Easy to upgrade, lower part count, shorter time to market and IP protection

Rugged Custom Power Modules

Various proposed solutions offer different costs and low volume of entry

	Industrial Application	Extended Temp. Application	Harsh Environment Application	
Standard module	•			No NRE Low-volume entry
Modified standard module	•	•		Low NRE Low-volume entry
Custom module	•	•	•	Medium to high NRE Low-volume entry

Flexibility

- Great level of integration
- Mix of silicon within the same package
- No quantity limitation

Technology

- Application oriented

Packaging Capability

- Standard and custom packages
- Standard and custom terminals
- Various substrate technologies

Reliability

- Coefficient of thermal expansion matching

Applications

- Solar, welding, plasma cutting, semicap, MRI and X-ray, EV/HEV, induction heating, UPS, motor control, data communication

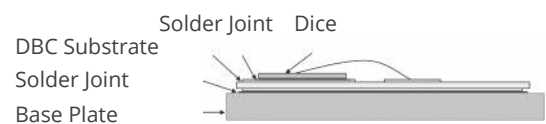



Rugged Custom Power Modules

Microchip has acquired much experience and know-how in module customization that addresses rugged and wide temperature range applications, offering solutions to meet the expectations of next-generation integrated power systems for the following attributes:

- Improved reliability
- Wider operating temperatures
- Higher power
- Higher efficiency
- Lower weight and size
- Lower cost

Applications

- Avionics actuation system
- Avionics lift and pump
- Military ground vehicle
- Power supply and motor control
- Navy ship auxiliary power supply
- Down hole drilling

Test Capabilities

- X-Ray inspection
- Dielectric test (up to 6 kV)
- Electrical testing at specified temperature
- Burn-in
- Acoustic imaging

Reliability Testing Capabilities

- Power cycling
- Hermetic sealing
- Moisture
- Salt atmosphere
- HTGB
- Temperature shock
- HAST
- H3TRB
- Altitude
- Mechanical shock, vibration

Expertise Capabilities

- Cross-sectioning
- Structural analysis

All tests can be conducted upon demand by sampling or at 100 percent. Tests can be performed in-house or in an external lab.

Our Core Competencies

- Extensive experience with rugged solutions for harsh environments
- Wide range of silicon technologies
- Wafer fab capabilities
- Mix of assembly technologies
- Hermetic and robust plastic packages
- Custom test and burn-in solutions
- ISO9001-certified
- End-of-life (obsolescence) management
- Thermal management
- Material expertise
- Product life management and risk analysis



Module performance and reliability depends on the choice of assembly materials

Temperature Coefficients of Expansion (TCEs) with more closely matched materials increase the module's lifetime by reducing the stress at both the interface and interior of the materials.

The higher the thermal conductivity, the lower the junction-to-case thermal resistance and the lower the delta of junction temperature of the device during operation. This will minimize the effect of power cycling on the dice.

Another important feature is the material density, particularly for the baseplate. Taking copper as the reference, AlSiC has a density of 1/3, while CuW has twice the density. Therefore, AlSiC will provide substantial weight reduction while increasing reliability.

	CTE (ppm/K)	Thermal Conductivity (W/m.K)	R _{θJC} or R _{θJc} (K/W)
Silicon die (120 mm ²)	4	136	
Cu/Al ₂ O ₃	17/7	390/25	0.35
AlSiC/Al ₂ O ₃	7/7	170/25	0.38
Cu/AlN	17/5	390/170	0.28
AlSiC/AlN	7/5	170/170	0.31
AlSiC/Si ₃ N ₄	7/3	170/60	0.31

	Material	CTE (ppm/K) (W/m.K)	Thermal Conductivity	Density (g/cc)
Base plate	CuW	6.5	190	17
	AlSiC	7	170	2.9
	Cu	17	390	8.9
Substrate	Al ₂ O ₃	7	25	
	AlN	5	170	
	Si ₃ N ₄	3	60	
Die	Si	4	136	
	SiC	2.6	270	

Power Module Part Numbering System

IGBT Modules

APT MSC	GL	475	A	120	T	D3	G
I	II	III	IV	V	VI	VII	VIII

- I** TradeMark
- II** IGBT Type:
GL = TRENCH 4
GLQ = High-speed TRENCH 4
GT = TRENCH 3
GTQ = TRENCH 5
GV = Mix NPT/TRENCH
CV = Mix TRENCH/Super Junction MOSFET
- III** Current:
 I_c at $T_c = 80^\circ\text{C}$
- IV** Topology:
A = Phase Leg
BB = Boost Buck
DA = Boost Chopper
DDA = Double Boost Chopper
DH = Asymmetrical Bridge
DSK = Double Buck Chopper
DU = Dual Common Source
H = Full Bridge
HR = T-Type 3-Level
SDA = Double Boost + Bypass Diode
SK = Buck Chopper
TA = Triple Phase Leg
TDU = Triple Dual Common Source
TL = Three Level
U = Single Switch
VDA = Interleaved PFC
X = Three Phase Bridge
- V** Blocking Voltage:
60 = 600V
120 = 1200V
170 = 1700V
- VI** Option:
A = AlN Substrate
C = SiC Diode
D = Series Diode
E = PressFit
T = Temperature Sensor
W = Clamping Parallel Diode
- VII** Package:
1 = SP1, SP1F
3 = SP3F
P = SP6-P
D3 = D3 (62 mm)
D4 = D4 (62 mm)
BL1, BL2, BL3 (Baseless)
- VIII** G = RoHS-compliant

MOSFET Modules

APT MSC	C	60	DA	M24	T	1	G
I	II	III	IV	V	VI	VII	VIII

- I** TradeMark
- II** MOSFET Type:
SM = SiC MOSFET
M = MOSFET
C = Super Junction MOSFET
- III** Blocking Voltage:
08 = 75V
10 = 100V
20 = 200V
50 = 500V
60 = 600V
70 = 700V
80 = 800V
100 = 1000V
120 = 1200V
170 = 1700V
- IV** Topology:
A = Phase Leg
BB = Boost Buck
DA = Boost Chopper
DDA = Double Boost Chopper
DH = Asymmetrical Bridge
DSK = Double Buck Chopper
DU = Dual Common Source
H = Full Bridge
HR = T-Type 3-Level
SDA = Double Boost and Bypass Diode
SK = Buck Chopper
TA = Triple Phase Leg
TDU = Triple Dual Common Source
TL = Three Level NPC
U = Single Switch
VDA = Interleaved PFC
- V** $R_{DS(on)}$ at $T_c = 25^\circ\text{C}$
240 = 2400 mΩ
24 = 240 mΩ
M24 = 24 mΩ
- VI** Option:
A = AlN Substrate
C = SiC Diode
D = Series Diode
E = PressFit
F = FREDFET
S = Series and Parallel Diodes
T = Temperature Sensor
U = Ultra-fast FREDFET
- VII** Package:
1 = SP1, SP1F
3 = SP3F
P = SP6-P
LI = SP6LI
BL1, BL2, BL3 (Baseless)
- VIII** G = RoHS-compliant

Diode Modules

APT MSC	DR	90	X	160	1	G
I	II	III	IV	V	VI	VII

- I** TradeMark
- II** Diode Type:
DF = FRED
DR = Standard Rectifier
DC = SiC
DSK = Schottky
- III** Current:
 I_f at $T_c = 80^\circ\text{C}$
- IV** Topology:
AA = Dual Common Anode
BB = Boost Buck
AK = Dual Series
KK = Dual Common Cathode
H = Single Phase Bridge
U = Single Switch
X = Three Phase Bridge
- V** Blocking Voltage:
20 = 200V
40 = 400V
60 = 600V
70 = 700V
100 = 1000V
120 = 1200V
160 = 1600V
170 = 1700V
- VI** Option:
E = PressFit
Package:
1 = SP1, SP1F
3 = SP3F
D1P = D1P
BL1, BL2, BL3 (Baseless)
- VII** G = RoHS-compliant

Optional Materials

Optional materials are available upon demand for most of the listed standard power modules. Options are indicated with a letter in the suffix of the module part number. The temperature sensor option is listed as "YES" or "OPTION" when available for a standard part or on-demand.

The following tables list the options available for our product categories.

- A** AlN substrate for higher thermal conductivity
- M** AlSiC base plate material for improved temperature cycling capabilities
- T** Temperature sensor (NTC or PTC) for case temperature information
- C** SiC diode for higher efficiency
- N** Si₃N₄ substrate
- E** Press fit terminals (for SP1F and SP3F package only)
- X** Gold pin terminals (SP1 only)
- L** Phase change material option

SiC MOSFET Power Module

Part Number	Electrical Topology	Voltage (V)	$R_{DS(on)}$ (m Ω)	Current (A) Tc = 80°C	Package (see page 24)	Gate Driver Core	Module Adapter Board	Plug and Play Driver	Developer Kit	
MSC100SM70JCU2	Boost chopper	700	15	97	SOT-227					
MSC40SM120JCU2		1200	40	44	SOT-227					
MSC70SM120JCU2			25	71	SOT-227					
MSC130SM120JCU2			12.5	138	SOT-227					
MSCSM120DAM11CT3AG			11	202	SP3F					
MSC100SM70JCU3	Buck chopper	700	15	97	SOT-227					
MSC40SM120JCU3		1200	40	44	SOT-227					
MSC70SM120JCU3			25	71	SOT-227					
MSC130SM120JCU3			12.5	138	SOT-227					
MSCSM120SKM11CT3AG			11	202	SP3F					
MSCSM70HM19CT3AG	Full bridge	700	15	97	SP3F					
MSCSM120HM31CT3AG		1200	25	71	SP3F					
MSCSM120HM16CT3AG			12.5	138	SP3F					
MSCSM120HM50CT3AG			40	44	SP3F					
MSCSM120HM063CAG			6.3	265	SP6C					
MSCSM120HM083CAG		8.3	200	SP6C						
MSCSM170HM45CT3AG		1700	35	50	SP3F					
MSCSM170HM23CT3AG			17.5	97	SP3F					
MSCSM170HM087CAG			8.7	189	SP6C					
MSCSM170HM12CAG			11.7	142	SP6C					
MSCSM70AM19CT1AG	Phase leg		700	15	97	SP1F				
MSCSM70AM07CT3AG				5	276	SP3F	2ASC-12A2HP 2ASC-12A1HP			
MSCSM70AM10CT3AG		7.5		188	SP3F	2ASC-12A2HP 2ASC-12A1HP				
MSCSM70AM025CD3AG		2.5		538	D3	2ASC-12A2HP 2ASC-12A1HP	62CA1	62EM1-00001	ASDAK-2ASC-12A1HP-62	
MSCSM70AM025CT6AG		2.5		538	SP6C	2ASC-12A2HP 2ASC-12A1HP	62CA1	62EM1-00001	ASDAK-2ASC-12A1HP-62	
MSCSM70AM025CT6LIAG		2.5		538	SP6LI	2ASC-12A2HP 2ASC-12A1HP	SP6CA1		ASDAK-2ASC-12A1HP-SP6LI	
MSCSM70AM025CT6LIAG		2.5		538	SP6LI	2ASC-12A2HP 2ASC-12A1HP	SP6CA1		ASDAK-2ASC-12A1HP-SP6LI	
MSCSM120AM31CT1AG		25		71	SP1F					
MSCSM120AM50CT1AG		40		44	SP1F					
MSCSM120AM08CT3AG		6.25		268	SP3F	2ASC-12A2HP 2ASC-12A1HP				
MSCSM120AM11CT3AG		8.33	202	SP3F	2ASC-12A2HP 2ASC-12A1HP	62CA1	62EM1-00001			
MSCSM120AM042CT6LIAG		4.2	394	SP6LI	2ASC-12A2HP 2ASC-12A1HP	SP6CA1		ASDAK-2ASC-12A1HP-SP6LI		
MSCSM120AM042CD3AG		4.2	394	D3	2ASC-12A2HP 2ASC-12A1HP	62CA1	62EM1-00001	ASDAK-2ASC-12A1HP-62		
MSCSM120AM027CD3AG		2.7	584	D3	2ASC-12A2HP 2ASC-12A1HP	62CA1	62EM1-00001	ASDAK-2ASC-12A1HP-62		
MSCSM120AM042CT6AG	4.2	394	SP6C	2ASC-12A2HP 2ASC-12A1HP	62CA1	62EM1-00001	ASDAK-2ASC-12A1HP-62			
MSCSM120AM027CT6AG	2.7	584	SP6C	2ASC-12A2HP 2ASC-12A1HP	62CA1	62EM1-00001	ASDAK-2ASC-12A1HP-62			
MSCSM120AM03CT6LIAG	2.5	641	SP6LI	2ASC-12A2HP 2ASC-12A1HP	SP6CA1		ASDAK-2ASC-12A1HP-SP6LI			
MSCSM120AM02CT6LIAG	2.1	754	SP6LI	2ASC-12A2HP 2ASC-12A1HP	SP6CA1		ASDAK-2ASC-12A1HP-SP6LI			

SiC MOSFET Power Modules (continued)

Part Number	Electrical Topology	Voltage (V)	$R_{DS(on)}$ (m Ω)	Current (A) $T_c = 80^\circ\text{C}$	Package (see page 24)	Gate Driver Core	Module Adapter Board	Plug and Play Driver	Developer Kit
MSCSM170AM23CT1AG	Phase leg	1700	17.5	97	SP1F				
MSCSM170AM45CT1AG			35	50	SP1F				
MSCSM170AM11CT3AG			8.75	188	SP3F	2ASC-17A1HP			
MSCSM170AM15CT3AG			11.7	142	SP3F	2ASC-17A1HP			
MSCSM170AM058CD3AG			5.8	277	D3	2ASC-17A1HP	62CA4	62EM1-00001	ASDAK-2ASC-17A1HP-62
MSCSM170AM039CD3AG			3.9	410	D3	2ASC-17A1HP	62CA4	62EM1-00001	ASDAK-2ASC-17A1HP-62
MSCSM170AM058CT6AG			5.8	277	SP6C	2ASC-17A1HP	62CA4	62EM1-00001	ASDAK-2ASC-17A1HP-62
MSCSM170AM039CT6AG			3.9	410	SP6C	2ASC-17A1HP	62CA4	62EM1-00001	ASDAK-2ASC-17A1HP-62
MSCSM170AM029CT6LIAG			2.9	530	SP6LI	2ASC-17A1HP	SP6CA3		
MSCSM170AM058CT6LIAG			5.8	277	SP6LI	2ASC-17A1HP	SP6CA3		
MSCSM70VM19C3AG	Vienna phase leg	700	15	97	SP3F				
MSCSM70VM10C4AG			7.5	97	SP4				
MSCSM70TAM19CT3AG	Three phase bridge Triple phase leg	700	15	97	SP3F				
MSCSM70TAM10CTPAG			7.5	186	SP6P				
MSCSM70TAM05TPAG			5	273	SP6P				
MSCSM120TAM31CT3AG		1200	25	71	SP3F				
MSCSM120TAM16CTPAG			12.5	136	SP6P				
MSCSM120TAM11CTPAG			8.33	200	SP6P				
MSCSM70VR1M03CT6AG			Vienna Rectifier	700	3	465	SP6C		
MSCSM70VR1M07CT6AG	5	278			SP6C				
MSCSM70VR1M10CT3AG	7.5	192			SP3F				
MSCSM70VR1M19C1AG	15	98			SP1F				
MSCSM120VR1M062CT6AG	1200	5		334	SP6C				
MSCSM120VR1M11CT6AG		8.3		200	SP6C				
MSCSM120VR1M16CT3AG		12.5		138	SP3F				
MSCSM120VR1M31C1AG		25		71	SP1F				

Dual Common Source and Three Level Inverter Modules

Part Number	Electrical Topology	Voltage (V)	RDS(on) (mΩ)	Current (A) Tc=80 C	Package (See Pg 24)	
MSCSM70DUM07T3AG	Dual common source	700	5	281	SP3F	
MSCSM70DUM10T3AG			7.5	191	SP3F	
MSCSM70DUM017AG			1.7	812	SP6C	
MSCSM70DUM025AG			2.5	548	SP6C	
MSCSM120DUM08T3AG		1200	1200	6.25	268	SP3F
MSCSM120DUM11T3AG				8.3	202	SP3F
MSCSM120DUM16T3AG				12.5	138	SP3F
MSCSM120DUM027AG				2.8	584	SP6C
MSCSM120DUM042AG		1700	1700	4.2	394	SP6C
MSCSM170DUM11T3AG				8.8	191	SP3F
MSCSM170DUM15T3AG				11.6	144	SP3F
MSCSM170DUM23T3AG				17.5	98	SP3F
MSCSM170DUM039AG		Three level inverter	700	3.9	416	SP6C
MSCSM170DUM058AG				5.8	281	SP6C
MSCSM70TLM10C3AG	7.5			191	SP3F	
MSCSM70TLM19C3AG	15			98	SP3F	
MSCSM70TLM44C3AG	35		45	SP3F		
MSCSM70TLM05CAG	3.8		369	SP6C		
MSCSM70TLM07CAG	5		278	SP6C		
MSCSM120TLM16C3AG	1200		1200	12.5	138	SP3F
MSCSM120TLM31C3AG				25	71	SP3F
MSCSM120TLM50C3AG				40	44	SP3F
MSCSM120TLM11CAG		8.3		200	SP6C	
MSCSM120TLM08CAG	1700	1700	6.25	265	SP6C	
MSCSM170TLM23C3AG			17.5	98	SP3F	
MSCSM170TLM45C3AG			35	51	SP3F	
MSCSM170TLM15CAG			11.7	142	SP6C	
MSCSM170TLM11CAG			8.8	189	SP6C	

Baseless Power Modules

Part Number	Silicon type	Configuration	VDS (V)	RDSon type (mΩ)	Current (A) Tc=80 C	Package (see page 25)
MSCSM120DHM31CTBL2NG	SiC MOSFET	Asymmetrical bridge	1200	25	60	BL2
MSCSM120DAM31CTBL1NG	SiC MOSFET	Boost chopper		25	60	BL1
MSCSM120SKM31CTBL1NG	SiC MOSFET	Buck chopper		25	60	BL1
MSCSM120DUM31CTBL1NG	SiC MOSFET	Dual common source		25	60	BL1
MSCSM120DDUM31CTBL2NG	SiC MOSFET	Dual common source		25	60	BL2
MSCSM120DDUM16CTBL3NG	SiC MOSFET	Dual common source		12.5	120	BL3
MSCSM120HM31CTBL2NG	SiC MOSFET	Full bridge		25	60	BL2
MSCSM120HM16CTBL3NG	SiC MOSFET	Full bridge		12.5	120	BL3
MSCSM120AM31CTBL1NG	SiC MOSFET	Phase leg		25	60	BL1

Part Number	Silicon type	Configuration	VCE (V)	VCEsat (V)	Current (A) Tc=80 C	Package (see page 25)
MSCGLQ50DH120CTBL2NG	TRENCH 4 FAST	Asymmetrical bridge	1200	2.05	50	BL2
MSCGLQ50DU120CTBL1NG	TRENCH 4 FAST	Dual common source		2.05	50	BL1
MSCGLQ50DDU120CTBL2NG	TRENCH 4 FAST	Dual common source		2.05	50	BL2
MSCGLQ75DDU120CTBL3NG	TRENCH 4 FAST	Dual common source		2.05	75	BL3
MSCGLQ50H120CTBL2NG	TRENCH 4 FAST	Full bridge		2.05	50	BL2
MSCGLQ75H120CTBL3NG	TRENCH 4 FAST	Full bridge		2.05	75	BL3
MSCGLQ50A120CTBL1NG	TRENCH 4 FAST	Phase leg		2.05	50	BL1

Part Number	Silicon type	Configuration	VRRM (V)	VF (V)	Current (A) Tc=80 C	Package (see page 25)
MSCDR90A160BL1NG	Rectifier diode	Phase leg	1600	1.3	90	BL1

SiC Diode Power Module

Power Module Advantages

- High-speed switching
- Low switching losses
- Low-input capacitance
- High-power density
- Low-profile packages
- Minimum parasitic inductance
- Lower system cost
- Standard and custom modules
- 30+ years design experience

SiC Diode Power Modules

Part Number	Electrical Topology	Voltage (V)	Current (A) Tc = 80°C	Package (see page 24)
MSCDC50H701AG	Full bridge	700	50	SP1
MSC50DC70HJ			50	SOT-227
MSCDC100H70AG			100	SP6
MSCDC200H70AG			200	SP6
MSCDC50H1201AG		1200	50	SP1
MSC50DC120HJ			50	SOT-227
MSCDC100H120AG			100	SP6
MSCDC200H120AG			200	SP6
MSCDC100H170AG		1700	100	SP6C
MSCDC200H170AG			200	SP6C
MSCDC50H1701AG			50	SP1
MSC50DC170HJ			50	SOT-227
MSCDC100A70D1PAG	Phase leg	700	100	D1P
MSCDC150A70D1PAG			150	D1P
MSCDC200A70D1PAG			200	D1P
MSCDC300A70AG			300	SP6
MSCDC450A70AG			450	SP6
MSCDC600A70AG			600	SP6
MSCDC100A120D1PAG	1200	100	D1P	
MSCDC150A120D1PAG		150	D1P	
MSCDC200A120D1PAG		200	D1P	
MSCDC300A120AG		300	SP6	
MSCDC450A120AG		450	SP6	
MSCDC600A120AG		600	SP6	
MSCDC300A170AG	1700	300	SP6C	
MSCDC450A170AG		450	SP6C	
MSCDC600A170AG		600	SP6C	
MSCDC100A170D1PAG		100	D1P	
MSCDC150A170D1PAG		150	D1P	
MSCDC200A170D1PAG		200	D1P	
MSCDC100KK70D1PAG	Dual common cathode	700	100	D1P
MSCDC150KK70D1PAG			150	D1P
MSCDC200KK70D1PAG			200	D1P
MSCDC100KK120D1PAG		1200	100	D1P
MSCDC150KK120D1PAG			150	D1P
MSCDC200KK120D1PAG			200	D1P
MSCDC100KK170D1PAG		1700	100	D1P
MSCDC150KK170D1PAG			150	D1P
MSCDC200KK170D1PAG			200	D1P
MSCDC50X701AG	Three phase bridge	1200	50	SP1
MSCDC50X1201AG			50	SP1
MSCDC50X1701AG			50	SP1

IGBT & Si MOSFET Power Modules with SiC Diodes

Boost Chopper

V_{RRM} (V)	IGBT Type	I_D (A) $T_c = 80^\circ\text{C}$	$V_{CE(ON)}$ (V) at Rated I_c	Package (see page 24)	NTC	Part Number
1200	Trench 4 Fast	25	2.05	SOT-227	No	APT25GLQ120JCU2
		40	2.05	SOT-227	No	APT40GLQ120JCU2

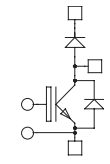

Dual Chopper

V_{RRM} (V)	IGBT Type	I_D (A) $T_c = 80^\circ\text{C}$	$V_{CE(ON)}$ (V) at Rated I_c	Package (see page 24)	NTC	Part Number
1200	Trench 4 Fast	40	2.05	SP3F	Yes	APTGLQ40DDA120CT3G

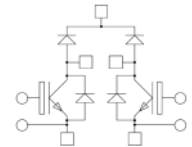

MOSFETs and Super Junction MOSFET Power Modules With SiC Diodes

Single Switch + Series FRED and SiC Parallel Diodes

V_{DSS} (V)	MOSFET Type	$R_{DS(ON)}$ (m Ω)	I_D (A) $T_c = 80^\circ\text{C}$	Package (see page 24)	NTC	Part Number
1000	MOS 7	65	110	SP6	Option	APTM100UM65SCAVG
1200	MOS 7	100	86	SP6	Option	APTM120U10SCAVG

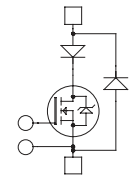

Power Modules With SiC Schottky Diodes

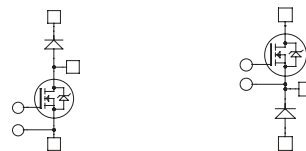

Chopper

V_{DSS} (V)	MOSFET Type	$R_{DS(ON)}$ (m Ω)	I_D (A) $T_c = 80^\circ\text{C}$	Package (see page 24)	NTC	...DA... or ...U2	...SK... or ...U3
500	MOS 8	65	43	SOT-227	No	APT58M50JCU2	
		45	38	SOT-227	No	APT50N60JCCU2	
600	Super Junction MOSFET	24	70	SP1	Yes		APTC60SKM24CT1G
		18	107	SP4	Yes	APTC60DAM18CTG	
1000	MOS 8	330	20	SOT-227	No	APT26M100JCU2	APT26M100JCU3
1200	MOS 8	560	15	SOT-227	No	APT20M120JCU2	APT20M120JCU3
		300	23	SP1	Yes	APTM120DA30CT1G	

Phase Leg + Series FRED and SiC Parallel Diodes

V_{DSS} (V)	MOSFET Type	$R_{DS(ON)}$ (m Ω)	I_D (A) $T_c = 80^\circ\text{C}$	Package (see page 24)	NTC	Part Number
500	MOS 7	38	67	SP4	Yes	APTM50AM38SCTG
		24	110	SP6	No	APTM50AM24SCG
600	Super Junction MOSFET	35	54	SP4	Yes	APTC60AM35SCTG
		24	70	SP4	Yes	APTC60AM24SCTG
		18	107	SP6	No	APTC60AM18SCG
800	Super Junction MOSFET	150	21	SP4	Yes	APTC80A15SCTG
		100	32	SP4	Yes	APTC80A10SCTG
		75	43	SP6	No	APTC80AM75SCG
1000	MOS 7	130	49	SP6	No	APTM100A13SCG

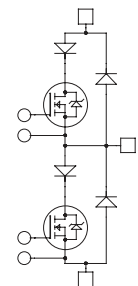



Full Bridge + Series FRED and SiC Parallel Diodes

V _{DSS} (V)	MOSFET Type	R _{DS(on)} (mΩ)	I _D (A) T _C = 80°C	Package (see page 24)	NTC	Part Number
500	MOS 7	75	34	SP4	Yes	APTM50HM75SCTG
600	Super Junction MOSFET	70	29	SP4	Yes	APTC60HM70SCTG
		45	38	SP4	Yes	APTC60HM45SCTG
800		290	11	SP4	Yes	APTC80H29SCTG
1000	MOS 7	450	14	SP4	Yes	APTM100H45SCTG

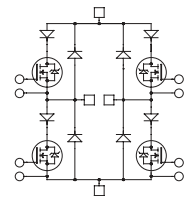

Triple Phase Leg

V _{DSS} (V)	MOSFET Type	R _{DS(on)} (mΩ)	I _D (A) T _C = 80°C	Package (see page 24)	NTC	Part Number
600	Super Junction MOSFET	24	87	SP6-P	Yes	APTC60TAM21SCTPAG
1000	MOS 7	350	50	SP6-P	Yes	APTM100TA35SCTPG

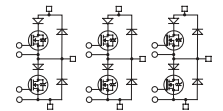

IGBT Power Modules

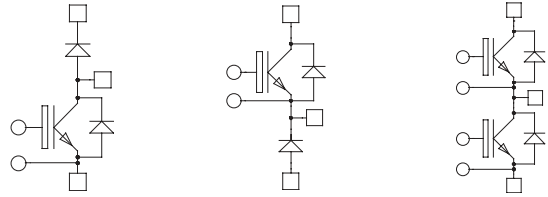

Chopper and Phase Leg

$V_{(BR)CES}$ (V)	IGBT Type	I_c (A) $T_c = 80^\circ\text{C}$	$V_{CE(ON)}$ (V) at Rated I_c	Package (see page 24)	NTC	...DA... or ...U2	...SK... or ...U3	...A...
600	TRENCH 3	75	1.5	SP1	YES	APTGT75DA60T1G		APTGT75A60T1G
		100	1.5	SP1	YES	APTGT100DA60T1G		APTGT100A60T1G
		150	1.5	SP1	YES	APTGT150DA60T1G	APTGT150SK60T1G	APTGT150A60T1G
		150	1.5	SP3F	YES			APTGT150A60T3AG
		200	1.5	SP3F	YES	APTGT200DA60T3AG	APTGT200SK60T3AG	APTGT200A60T3AG
		300	1.5	SP4	YES			APTGT300A60TG
		300	1.5	SP6	OPTION	APTGT300DA60G	APTGT300SK60G	APTGT300A60G
		300	1.5	D3	OPTION	APTGT300DA60D3G	APTGT300SK60D3G	APTGT300A60D3G
		400	1.5	D3	OPTION	APTGT400DA60D3G		APTGT400A60D3G
		450	1.5	SP6	OPTION	APTGT450DA60G	APTGT450SK60G	APTGT450A60G
600	1.5	SP6	OPTION	APTGT600DA60G	APTGT600SK60G	APTGT600A60G		
650	TRENCH 4 FAST	50	1.85	SOT227		APT50GLQ65JU2		
		50	1.85	SOT227		APT100GLQ65JU2	APT100GLQ65JU3	
		100	1.85	SP1	YES			APTGLQ100A65T1G
650	TRENCH 5	60	1.65	SP1	YES	APTGTQ100DA65T1G	APTGTQ100SK65T1G	APTGTQ100A65T1G
		120	1.65	SP3F	YES	APTGTQ200DA65T3G	APTGTQ200SK65T3G	APTGTQ200A65T3G
1200	TRENCH 3	35	1.7	SP1	YES			APTGT35A120T1G
		35	1.7	SOT227	-	APT35GT120JU2	APT35GT120JU3	
		50	1.7	SOT227	-	APT50GT120JU2	APT50GT120JU3	
		50	1.7	SP1	YES			APTGT50A120T1G
		50	1.7	SP4	YES	APTGT50DA120TG	APTGT50SK120TG	
		75	1.7	SOT227	-	APT75GT120JU2	APT75GT120JU3	
		75	1.7	SP1	YES			APTGT75A120T1G
		75	1.7	SP4	YES	APTGT75DA120TG	APTGT75SK120TG	
		100	1.7	SP1	YES	APTGT100DA120T1G		
		100	1.7	SOT227	-	APT100GT120JU2	APT100GT120JU3	
		100	1.7	SP3F	YES			APTGT100A120T3AG
		100	1.7	SP4	YES			APTGT100A120TG
		150	1.7	SP6	OPTION	APTGT150DA120G	APTGT150SK120G	APTGT150A120G
		150	1.7	SP3F	YES			APTGT150A120T3AG
		150	1.7	SP4	YES			APTGT150A120TG
		200	1.7	SP6	OPTION	APTGT200DA120G	APTGT200SK120G	APTGT200A120G
		200	1.7	D3	OPTION	APTGT200DA120D3G		APTGT200A120D3G
		300	1.7	SP6	OPTION	APTGT300DA120G	APTGT300SK120G	APTGT300A120G
		300	1.7	D3	OPTION			APTGT300A120D3G
		400	1.7	SP6	OPTION	APTGT400DA120G	APTGT400SK120G	APTGT400A120G
400	1.7	D3	OPTION			APTGT400A120D3G		
1200	TRENCH 4	40	1.85	SOT227	-	APT40GL120JU2	APT40GL120JU3	
		90	1.85	SP1	YES	APTGL90DA120T1G		APTGL90A120T1G
		180	1.85	SP3F	YES			APTGL180A120T3AG
		325	1.85	D3	OPTION			APTGL325A120D3G
		475	1.85	D3	OPTION	APTGL475DA120D3G	APTGL475SK120D3G	APTGL475A120D3G
	TRENCH 4 FAST	700	1.85	D3	OPTION	APTGL700DA120D3G	APTGL700SK120D3G	
		100	2.05	SP3F	YES			APTGLQ100A120T3AG
		100	2.05	SP1	YES	APTGLQ100DA120T1G		
		100	2.05	SP4	YES			APTGLQ100A120TG
		150	2.05	SP4	YES			APTGLQ150A120TG
200	2.05	SP3F	YES			APTGLQ200A120T3AG		
300	2.05	SP6C			APTGLQ300SK120G	APTGLQ300A120G		
400	2.05	SP6	YES			APTGLQ400A120T6G		
1700	TRENCH 3	30	2	SP1	YES			APTGT30A170T1G
		50	2	SP1	YES		APTGT50SK170T1G	APTGT50A170T1G
		50	2	SP4	YES		APTGT50SK170TG	APTGT50A170TG
		100	2	SP4	YES		APTGT100SK170TG	APTGT100A170TG
		150	2	SP6	OPTION		APTGT150SK170G	
		200	2	D3	OPTION			APTGT200A170D3G
		225	2	SP6	OPTION		APTGT225SK170G	APTGT225A170G
		300	2	SP6	OPTION	APTGT300DA170G	APTGT300SK170G	APTGT300A170G
		300	2	D3	OPTION	APTGT300DA170D3G		APTGT300A170D3G

Three-Phase Bridge

$V_{(BR)CES}$ (V)	IGBT Type	I_c (A) $T_c = 80^\circ\text{C}$	$V_{CE(ON)}$ (V) at Rated I_c	Package (see page 24)	NTC	Part Number
600	TRENCH 3	30	1.5	SP3F	Yes	APTGT30X60T3G
		50	1.5	SP3F	Yes	APTGT50X60T3G
		75	1.5	SP3F	Yes	APTGT75X60T3G
1200	TRENCH 3	25	1.7	SP3F	Yes	APTGT25X120T3G
		35	1.7	SP3F	Yes	APTGT35X120T3G
	TRENCH 4	40	1.85	SP3F	Yes	MSCGL40X120T3AG
		40	1.85	SP3F	Yes	APTGL40X120T3G

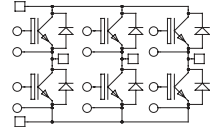

Three-Phase Leg

$V_{(BR)CES}$ (V)	IGBT Type	I_c (A) $T_c = 80^\circ\text{C}$	$V_{CE(ON)}$ (V) at Rated I_c	Package (see page 24)	NTC	Part Number
600	TRENCH 3	50	1.5	SP6-P	Option	APTGT50TA60PG
		150	1.5	SP6-P	Option	APTGT150TA60PG
650	TRENCH 5	30	1.65	SP3F	Yes	APTGTQ50TA65T3G
		90	1.65	SP6-P	Yes	APTGTQ150TA65TPG
1200	TRENCH 3	75	1.7	SP6-P	Option	APTGT75TA120PG
		100	1.7	SP6-P	Yes	APTGT100TA120TPG
	TRENCH 4	120	1.85	SP6-P	Yes	APTGL120TA120TPG

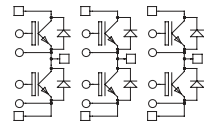

Triple Dual Common Source

$V_{(BR)CES}$ (V)	IGBT Type	I_c (A) $T_c = 80^\circ\text{C}$	$V_{CE(ON)}$ (V) at Rated I_c	Package (see page 24)	NTC	Part Number
600	TRENCH 3	50	1.5	SP6-P	Option	APTGT50TDU60PG
		75	1.5	SP6-P	Option	APTGT75TDU60PG
		100	1.5	SP6-P	Option	APTGT100TDU60PG
		150	1.5	SP6-P	Option	APTGT150TDU60PG
1200	TRENCH 3	75	1.7	SP6-P	Option	APTGT75TDU120PG
	TRENCH 4	120	1.85	SP6-P	Yes	APTGL120TDU120TPG
1700	TRENCH 3	50	2	SP6-P	Option	APTGT50TDU170PG

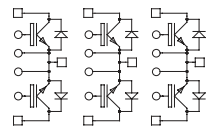

Dual Chopper

$V_{(BR)CES}$ (V)	IGBT Type	I_c (A) $T_c = 80^\circ\text{C}$	$V_{CE(ON)}$ (V) at Rated I_c	Package	NTC	...DDA...	...DSK...
600	TRENCH 3	50	1.5	SP3F	Yes	APTGT50DDA60T3G	
		75	1.5	SP3F	Yes	APTGT75DDA60T3G	
650	TRENCH 5	60	1.65	SP3F	Yes	APTGTQ100DDA65T3G	
	TRENCH 4 FAST	50	1.85	SP3F	Yes	APTGLQ50DDA65T3G	
	TRENCH 4 FAST	50	1.85	SP3F	Yes	APTGLQ50VDA65T3G	
1200	TRENCH 3	50	1.7	SP3F	Yes	APTGT50DDA120T3G	
	TRENCH 4	60	1.85	SP3F	Yes	APTGL60DDA120T3G	
		90	1.85	SP3F	Yes	APTGL90DDA120T3G	APTGL90DSK120T3G

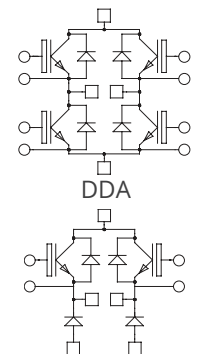

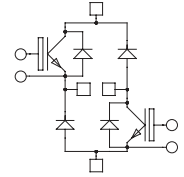
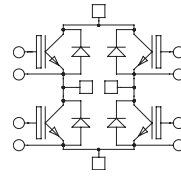

Full and Asymmetrical

$V_{(BR)CES}$ (V)	IGBT Type	I_c (A) $T_c = 80^\circ\text{C}$	$V_{CE(on)}$ (V) at Rated I_c	Package (see page 24)	NTC	...H...	...DH...
600	TRENCH 3	20	1.5	SP1	YES	APTGT20H60T1G	
		30	1.5	SP1	YES	APTGT30H60T1G	
		50	1.5	SP1	YES	APTGT50H60T1G	APTGT50DH60T1G
		50	1.5	SP3F	YES	APTGT50H60T3G	
		75	1.5	SP1	YES	APTGT75H60T1G	
		75	1.5	SP3F	YES	APTGT75H60T3G	
		100	1.5	SP4	YES	APTGT100H60TG	APTGT100DH60TG
		100	1.5	SP3F	YES	APTGT100H60T3G	
		150	1.5	SP4	YES	APTGT150H60TG	APTGT150DH60TG
650	TRENCH 4 FAST	30	1.95	SP3F	YES	APTGLQ30H65T3G	
		50	1.85	SP1	YES	APTGLQ50H65T1G	
		50	1.85	SP3F	YES	APTGLQ50H65T3G	
		75	1.85	SP1	YES	APTGLQ75H65T1G	
		100	1.85	SP3F	YES	APTGLQ100H65T3G	
		200	1.85	SP6C		APTGLQ200H65G	
650	TRENCH 5	300	1.85	SP6	OPTION	APTGLQ300H65G	
1200	TRENCH 3	60	1.65	SP3F	YES	APTGTQ100H65T3G	
		35	1.7	SP3F	YES	APTGT35H120T3G	
		50	1.7	SP3F	YES	APTGT50H120T3G	
		50	1.7	SP4	YES		APTGT50DH120TG
		75	1.7	SP3F	YES		APTGT75DH120T3G
		75	1.7	SP4	YES	APTGT75H120TG	
		100	1.7	SP4	YES		APTGT100DH120TG
		100	1.7	SP6		APTGT100H120G	
	150	1.7	SP6		APTGT150H120G	APTGT150DH120G	
	200	1.7	SP6		APTGT200H120G	APTGT200DH120G	
	TRENCH 4	40	1.85	SP1	YES	APTGL40H120T1G	
		60	1.85	SP3F	YES	APTGL60H120T3G	
		90	1.85	SP3F	YES	APTGL90H120T3G	
	TRENCH 4 FAST	25	2.05	SP1	YES	APTGLQ25H120T1G	
		40	2.05	SP1	YES	APTGLQ40H120T1G	
75		2.05	SP3F	YES	APTGLQ75H120T3G		
75		2.05	SP4	YES	APTGLQ75H120TG		
150		2.05	SP6C		APTGLQ150H120G		
200	2.05	SP6	OPTION	APTGLQ200H120G			
1700	TRENCH 3	30	2	SP3F	YES	APTGT30H170T3G	
		50	2	SP4	YES	APTGT50H170TG	APTGT50DH170TG
		100	2	SP6		APTGT100H170G	
		150	2	SP6			APTGT150DH170G

Single Switch

V _{CES} (V)	IGBT Type	I _c (A) T _c = 80°C	V _{CE (ON)} (V) at Rated I _c	Package (see page 24)	NTC	Part Number
600	TRENCH 3	750	1.5	D4	No	APTGT750U60D4G
1200	TRENCH 3	400	1.7	D4	No	APTGT400U120D4G
		600	1.7	D4	No	APTGT600U120D4G
	TRENCH 4	475	1.85	D4	No	APTGL475U120D4G
		700	1.85	D4	No	APTGL700U120D4G
1700	TRENCH 3	400	2	D4	No	APTGT400U170D4G
		600	2	D4	No	APTGT600U170D4G

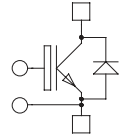

Single Switch + Series Diode

V _{CES} (V)	IGBT Type	I _c (A) T _c = 80°C	V _{CE (ON)} (V) at Rated I _c	Package (see page 24)	NTC	Part Number
1200	TRENCH 4	475	1.85	SP6	No	APTGL475U120DAG

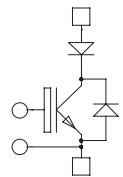

Dual Common Source

V _{CES} (V)	IGBT Type	I _c (A) T _c = 80°C	V _{CE (ON)} (V) at Rated I _c	Package (see page 24)	NTC	Part Number
600	TRENCH 3	100	1.5	SP4	Yes	APTGT100DU60TG
		200	1.5	SP4	Yes	APTGT200DU60TG
		300	1.4	SP6	No	APTGT300DU60G
		600	1.4	SP6	No	APTGT600DU60G
1200	TRENCH 3	50	1.7	SP4	Yes	APTGT50DU120TG
		75	1.7	SP4	Yes	APTGT75DU120TG
		100	1.7	SP4	Yes	APTGT100DU120TG
		150	1.7	SP6	No	APTGT150DU120G
		150	1.7	SP4	Yes	APTGT150DU120TG
		200	1.7	SP6	No	APTGT200DU120G
		300	1.7	SP6	No	APTGT300DU120G
		400	1.7	SP6	No	APTGT400DU120G
1700	TRENCH 3	100	2	SP4	Yes	APTGT100DU170TG
		225	2	SP6	No	APTGT225DU170G
		300	2	SP6	No	APTGT300DU170G

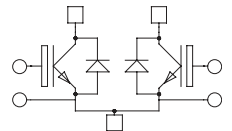

Intelligent Power Modules

Phase Leg

V _{CES} (V)	IGBT Type	I _c (A) T _c = 80°C	V _{CE (ON)} (V) at Rated I _c	Package (see page 24)	NTC	Part Number
600	TRENCH 3	400	1.5	LP8	No	APTLGT400A608G
1200	TRENCH 3	300	1.7	LP8	No	APTLGT300A1208G
	TRENCH 4	325	1.8	LP8	No	APTLGL325A1208G

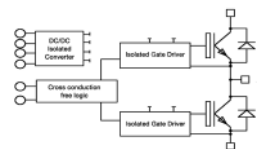

MOSFET Power Module

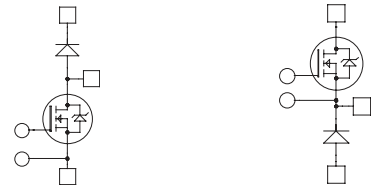

Chopper

V _{DSS} (V)	MOSFET Type	R _{DS(on)} (mΩ)	I _D (A) T _C = 80°C	Package (see page 24)	NTC	DA...or...U2	SK...or...U3
100	MOS 5	11	100	SOT-227	No	APT10M11JVU2	APT10M11JVU3
		4.5	207	SP4	Yes	APTM10DAM05TG	APTM10SKM05TG
		2.25	370	SP6	No	APTM10DAM02G	APTM10SKM02G
200	MOS 5	22	71	SOT-227	No	APT20M22JVU2	APT20M22JVU3
	MOS 7™	8	147	SP4	Yes	APTM20DAM08TG	APTM20SKM08TG
		5	250	SP6	Option	APTM20DAM05G	
		4	300	SP6	Option	APTM20DAM04G	APTM20SKM04G
500	MOS 5	100	30	SOT-227	No	APT5010JVU2	APT5010JVU3
	MOS 7	100	30	SOT-227	No	APT5010JLLU2	APT5010JLLU3
		75	32	SOT-227	No	APT50M75JLLU2	APT50M75JLLU3
		19	125	SP6	Option	APTM50DAM19G	APTM50SKM19G
		17	140	SP6	Option	APTM50DAM17G	APTM50SKM17G
MOS 8™	65	43	SOT-227	No	APT58M50JU2	APT58M50JU3	
600	Super Junction MOSFET	70	40	SOT-227	No	APT40N60JCU2	APT40N60JCU3
		24	70	SP1	Yes		APTC60SKM24T1G
1000	MOS 7	180	33	SP4	Yes	APTM100DA18TG	
		90	59	SP6	Option	APTM100DAM90G	
	MOS 8	330	17	SP1	Yes		APTM100SK33T1G
1200	MOS 8	300	23	SP1	Yes	APTM120DA30T1G	

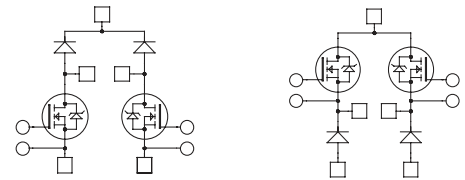

Dual Chopper

V _{DSS} (V)	MOSFET Type	R _{DS(on)} (mΩ)	I _D (A) T _C = 80°C	Package (see page 24)	NTC	...DDA...	...DSK...
100	MOS 5	19	50	SP3F	Yes		APTM10DSKM19T3G
		9	100	SP3F	Yes		APTM10DSKM09T3G
500	MOS 7™	100	24	SP3F	Yes	APTM50DDA10T3G	
		65	37	SP3F	Yes	APTM50DDAM65T3G	
600	Super Junction MOSFET	45	38	SP1	Yes	APTC60DDAM45T1G	
		70	29	SP1	Yes	APTC60DDAM70T1G	
		35	54	SP3F	Yes	APTC60DDAM35T3G	
		24	70	SP3F	Yes	APTC60DDAM24T3G	APTC60DSKM24T3G
800		150	21	SP3F	Yes	APTC80DDA15T3G	
1000	MOS 7	350	17	SP3F	Yes		APTM100DSK35T3G

Full Bridge

V _{DSS} (V)	MOSFET Type	R _{DS(on)} (mΩ)	I _D (A) T _C = 80°C	Package	NTC	Part Number
100	FREDFET 5	4.5	207	SP6	No	APTM10HM05FG
		19	50	SP3F	Yes	APTM10HM19FT3G
		9	100	SP3F	Yes	APTM10HM09FT3G
200	FREDFET 7	20	62	SP4	Yes	APTM20HM20FTG
		16	74	SP4	Yes	APTM20HM16FTG
		10	125	SP6	No	APTM20HM10FG
		8	147	SP6	No	APTM20HM08FG
500	FREDFET 7	140	18	SP3F	Yes	APTM50H14FT3G
		100	24	SP3F	Yes	APTM50H10FT3G
		75	32	SP4	Yes	APTM50HM75FTG
		75	32	SP3F	Yes	APTM50HM75FT3G
		65	37	SP4	Yes	APTM50HM65FTG
		65	37	SP3F	Yes	APTM50HM65FT3G
		38	64	SP6	No	APTM50HM38FG
	35	70	SP6	No	APTM50HM35FG	
600	Super Junction MOSFET	150	19	SP1	Yes	APTM50H15FT1G
		70	29	SP1	Yes	APTC60HM70T1G
		45	38	SP1	Yes	APTC60HM45T1G
		70	29	SP3F	Yes	APTC60HM70T3G
		35	54	SP3F	Yes	APTC60HM35T3G
		24	70	SP3F	Yes	APTC60HM24T3G
	FREDFET 8	230	15	SP1	Yes	APTM60H23FT1G
800	Super Junction MOSFET	150	21	SP1	Yes	APTC80H15T1G
		290	11	SP3F	Yes	APTC80H29T3G
		150	21	SP3F	Yes	APTC80H15T3G
1000	FREDFET 7	450	14	SP3F	Yes	APTM100H45FT3G
		350	17	SP4	Yes	APTM100H35FTG
		350	17	SP3F	Yes	APTM100H35FT3G
	FREDFET 8	180	33	SP6	No	APTM100H18FG
	FREDFET 8	460	14	SP3F	Yes	APTM100H46FT3G
1200	FREDFET 7	290	25	SP6	No	APTM120H29FG
	FREDFET 8	1400	6	SP1	Yes	APTM120H140FT1G

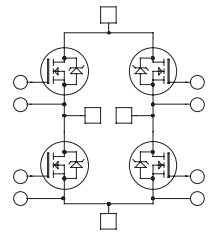

Full Bridge + Series and Parallel

V _{DSS} (V)	MOSFET Type	R _{DS(on)} (mΩ)	I _D (A) T _C = 80°C	Package	NTC	Part Number
200	MOS 7™	20	62	SP4	Yes	APTM20HM20STG
500	MOS 7	75	32	SP4	Yes	APTM50HM75STG
1000	MOS 7	450	13	SP4	Yes	APTM100H45STG

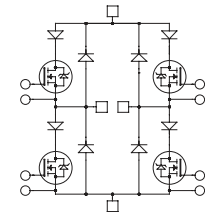

Asymmetrical Bridge

V _{DSS} (V)	MOSFET Type	R _{DS(on)} (mΩ)	I _D (A) T _C = 80°C	Package	NTC	Part Number
100	MOS 5	4.5	207	SP6	No	APTM10DHM05G
500	MOS 7™	38	64	SP6	No	APTM50DHM38G
600	Super Junction MOSFET	24	70	SP3F	Yes	APTC60DHM24T3G

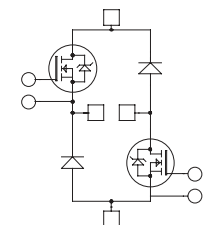

Phase Leg

V _{DSS} (V)	MOSFET Type	R _{Ds(on)} (mΩ)	I _D (A) T _C = 80°C	Package (see page 24)	NTC	Part Number
100	FREDFET 5	4.5	207	SP4	Yes	APTM10AM05FTG
		2.25	370	SP6	Option	APTM10AM02FG
200	FREDFET 7	10	125	SP4	Yes	APTM20AM10FTG
		8	147	SP4	Yes	APTM20AM08FTG
		5	250	SP6	Option	APTM20AM05FG
		5	280	LP8		MSCM20AM058G
		4	300	SP6	Option	APTM20AM04FG
500	FREDFET 7	38	64	SP4	Yes	APTM50AM38FTG
		35	70	SP4	Yes	APTM50AM35FTG
		19	125	SP6	Option	APTM50AM19FG
		17	140	SP6	Option	APTM50AM17FG
600	Super Junction MOSFET	45	38	SP1	Yes	APTC60AM45T1G
		35	54	SP1	Yes	APTC60AM35T1G
		24	70	SP1	Yes	APTC60AM24T1G
	FREDFET 8	110	30	SP1	Yes	APTM60A11FT1G
1000	FREDFET 7	180	33	SP4	Yes	APTM100A18FTG
		90	59	SP6	Option	APTM100AM90FG
1200	FREDFET 7	290	25	SP4	Yes	APTM120A29FTG
		150	45	SP6	Option	APTM120A15FG

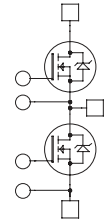
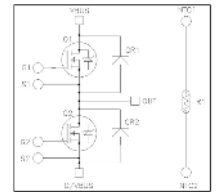
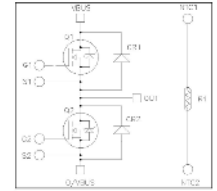

Phase Leg + Series and Parallel

V _{DSS} (V)	MOSFET Type	R _{Ds(on)} (mΩ)	I _D (A) T _C = 80°C	Package (see page 24)	NTC	Part Number
200	MOS 7™	10	125	SP4	Yes	APTM20AM10STG
		6	225	SP6	No	APTM20AM06SG
500	MOS 7	38	64	SP4	Yes	APTM50AM38STG
		24	110	SP6	No	APTM50AM24SG
1000	MOS 7	230	26	SP4	Yes	APTM100A23STG
		130	49	SP6	No	APTM100A13SG
1200	MOS 7	200	37	SP6	No	APTM120A20SG

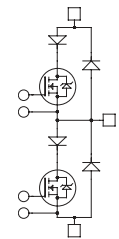

Phase Leg + Series Diodes

V _{DSS} (V)	MOSFET Type	R _{Ds(on)} (mΩ)	I _D (A) T _C = 80°C	Package (see page 24)	NTC	Part Number
1000	MOS 7	130	49	SP6	No	APTM100A13DG
1200	MOS 7	200	37	SP6	No	APTM120A20DG

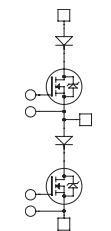

Triple Phase Leg

V _{DSS} (V)	MOSFET Type	R _{Ds(on)} (mΩ)	I _D (A) T _C = 80°C	Package (see page 24)	NTC	Part Number
75	MOSFET	4.2	90	SP6-P	Option	APTM08TAM04PG
100	FREDFET 5	19	50	SP6-P	Option	APTM10TAM19FPG
		9	100	SP6-P	Option	APTM10TAM09FPG
200	FREDFET 7	16	74	SP6-P	Option	APTM20TAM16FPG
500	FREDFET 7	65	37	SP6-P	Option	APTM50TAM65FPG
600	Super Junction MOSFET	35	54	SP6-P	Option	APTC60TAM35PG
		24	70	SP6-P	Yes	APTC60TAM24TPG
1000	FREDFET 7	350	17	SP6-P	Option	APTM100TA35FPG

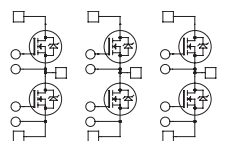

Three-Phase Bridge

V _{DSS} (V)	MOSFET Type	R _{DS(ON)} (mΩ)	I _D (A) T _C = 80°C	Package	NTC	Part Number
200	FREDFET 5	16	77	SP4		MSCM20XM16F4G
	FREDFET 5	10	84	SP3X		MSCM20XM10T3XG

Triple Dual Common Source

V _{DSS} (V)	MOSFET Type	R _{DS(ON)} (mΩ)	I _D (A) T _C = 80°C	Package (see page 24)	NTC	Part Number
600	Super Junction	35	54	SP6-P	Option	APTC60TDUM35PG
800	MOSFET	150	21	SP6-P	Option	APTC80TDU15PG

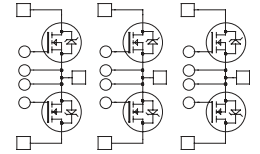

Dual Common Source

V _{DSS} (V)	MOSFET Type	R _{DS(ON)} (mΩ)	I _D (A) T _C = 80°C	Package (see page 24)	NTC	Part Number
100	MOS 5	2.25	370	SP6	No	APTM10DUM02G
200	MOS 7™	8	147	SP4	Yes	APTM20DUM08TG
		5	250	SP6	No	APTM20DUM05G
		4	300	SP6	No	APTM20DUM04G
1200	MOS 7	150	45	SP6	No	APTM120DU15G

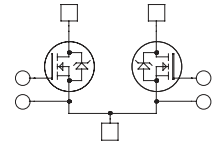

Single Switch

V _{DSS} (V)	MOSFET Type	R _{DS(ON)} (mΩ)	I _D (A) T _C = 80°C	Package (see page 24)	NTC	Part Number
100	FREDFET 5	2.25	430	SP6	Option	APTM10UM02FAG
		1.5	640	SP6	Option	APTM10UM01FAG
200	FREDFET 7	3	434	SP6	Option	APTM20UM03FAG
500	FREDFET 7	9	371	SP6	Option	APTM50UM09FAG
1000	FREDFET 7	60	97	SP6	Option	APTM100UM60FAG
		45	160	SP6	Option	APTM100UM45FAG
1200	FREDFET 7	70	126	SP6	Option	APTM120UM70FAG

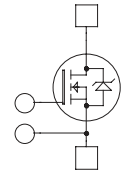

Single Switch + Series Diode

V _{DSS} (V)	MOSFET Type	R _{DS(ON)} (mΩ)	I _D (A) T _C = 80°C	Package (see page 24)	NTC	Part Number
1000	MOS 7™	65	110	SP6	No	APTM100UM65DAG
		45	160	SP6	No	APTM100UM45DAG
1200	MOS 7	70	126	SP6	No	APTM120UM70DAG

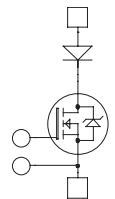

Single Switch + Series and Parallel

V _{DSS} (V)	MOSFET Type	R _{DS(ON)} (mΩ)	I _D (A) T _C = 80°C	Package (see page 24)	NTC	Part Number
200	MOS 7™	4	310	SP6	Option	APTM20UM04SAG
500	MOS 7	13	250	SP6	Option	APTM50UM13SAG
1000	MOS 7	65	110	SP6	Option	APTM100UM65SAG
1200	MOS 7	100	86	SP6	Option	APTM120U10SAG

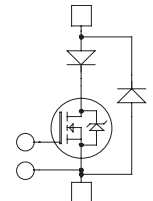

Interleaved PFC

V _{DSS} (V)	MOSFET Type	R _{DS(ON)} (mΩ)	I _D (A) T _C = 80°C	Package (see page 24)	NTC	Part Number
600	Super Junction	45	38	SP1	Yes	APTC60VDAM45T1G
	MOSFET	24	70	SP3F	Yes	APTC60VDAM24T3G

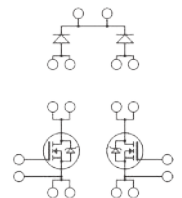

Renewable Energy Power Module

Full Bridge

V _{CE(S)} (V)	Technology	I _c (A) T _c = 80°C	V _{CE(ON)} (V) at Rated I _c	Package (see page 24)	NTC	Part Number
600	Mix Trench IGBT & Super Junction MOSFET	50	83 mΩ/1.5	SP1	Yes	APTCV40H60CT1G
		50	45 mΩ/1.5	SP3F	Yes	APTCV50H60T3G

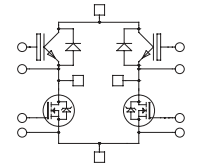

PFC + Bypass Diode + Phase Leg

V _{CE(S)} (V)	Technology	I _D (A) T _c = 80°C	R _{DS(on)} (V) at Rated I _D	Package (see page 24)	NTC	Special	Part Number
600	Super Junction MOSFET	38	45 mΩ	SP1	N/A	10A PFC SiC Diode	APTC60AM45BC1G
		38	45 mΩ	SP1	N/A		APTC60AM45B1G

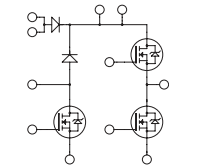

PFC + Bypass Diode + Full Bridge

V _{CE(S)} (V)	Technology	I _c (A) T _c = 80°C	V _{CE(ON)} (V) at Rated I _c	Package (see page 24)	NTC	Special	Part Number
600	Mix Trench IGBT & Super Junction MOSFET	38	1.5/45 mΩ	SP3F	Yes	20A PFC SiC Diode	APTCV60HM45BC20T3G
		38	1.5/45 mΩ	SP3F	Yes		APTCV60HM45BT3G
	Super Junction MOSFET	29	70 mΩ	SP3F	Yes		APTC60HM70BT3G

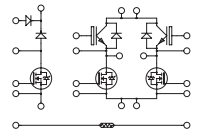

Secondary Fast Rectifier + Full Bridge

V _{CE(S)} (V)	Technology	I _c (A) T _c = 80°C	V _{CE(ON)} (V) at Rated I _c	Package (see page 24)	NTC	Special	Part Number
600	Mix Trench IGBT & Super Junction MOSFET	38	1.5/45 mΩ	SP3F	Yes	20A SiC Antiparallel Diode	APTCV60HM45RCT3G
		38	1.5/45 mΩ	SP3F	Yes		APTCV60HM45RT3G
	Super Junction MOSFET	29	70 mΩ	SP3F	Yes		APTC60HM70RT3G
	Trench 3	50	1.5	SP3F	Yes		APTGT50H60RT3G

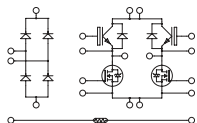

R_{DS(on)} value for the MOSFETs in mΩ and V_{CE(ON)} value for the IGBTs in Volts

Boost Buck

V _{CE(S)} (V)	Technology	I _c (A) T _c = 80°C	V _{CE(ON)} (V) at Rated I _c	Package (see page 24)	NTC	Part Number
600	Super Junction MOSFET	70	24 mΩ	SP3F	Yes	APTC60BBM24T3G
	Trench 3	100	1.5	SP3F	Yes	APTGT100BB60T3G

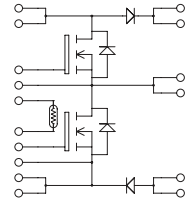

Three-Level NPC Inverter

V _{CE(S)} (V)	Technology	I _c (A) T _c = 80°C	V _{CE(ON)} (V) at Rated I _c	Package (see page 24)	NTC	Part Number
600	Trench 3	20	1.5	SP1	No	APTGT20TL601G
		30	1.5	SP1	No	APTGT30TL601G
		50	1.5	SP3F	Yes	APTGT50TL60T3G
		50	1.5	SP1	No	APTGT50TL601G
		75	1.5	SP3F	Yes	APTGT75TL60T3G
		100	1.5	SP3F	Yes	APTGT100TL60T3G
		150	1.5	SP6	No	APTGT150TL60G
		200	1.5	SP6	No	APTGT200TL60G
650	Trench 3	300	1.5	SP6	No	APTGT300TL65G
		400	1.5	SP6	No	APTGT400TL65G
1200	Trench 4	60	1.85	SP3F	Yes	APTGL60TL120T3G
		240	1.8	SP6	No	APTGL240TL120G
1700	Trench 3	100	2	SP6	No	APTGT100TL170G

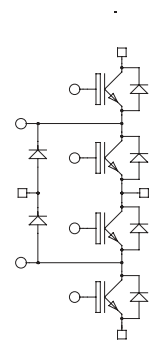

V _{CE(S)} (V)	Technology	R _{DS(ON)} Super Junction MOSFET (mΩ)	V _{CE(ON)} IGBT (V)/ I _c (A)	Package (see page 24)	NTC	Part Number
600	Mix Trench IGBT and Super Junction MOSFET	24	1.5/75	SP3F	Yes	APTCV60TLM24T3G
		45	1.5/75	SP3F	Yes	APTCV60TLM45T3G
		70	1.5/50	SP3F	Yes	APTCV60TLM70T3G
		99	1.5/30	SP3F	Yes	APTCV60TLM99T3G

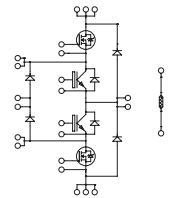

T-Type 3-Level Inverter

V _{CE(S)} (V)	Technology	I _c (A) T _c = 80°C	V _{CE(ON)} (V) at Rated I _c	Package (see page 24)	NTC	Special	Part Number
600/1200	Trench 4 Fast	40	2.05	SP3F	Yes	10A/600V SiC	APTGLQ40HR120CT3G
		80	2.05	SP3F	Yes	30A/600V SiC	APTGLQ80HR120CT3G
		200	2.05	SP6	No		APTGLQ200HR120G

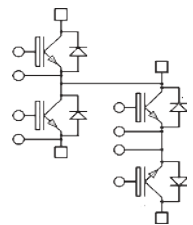

Vienna Rectifier

V _{CE(S)} (V)	IGBT Type	I _c (A) TC = 80°C	V _{CE(ON)} (V) at Rated I _c	Package (see page 24)	NTC	Part Number
600	Super Junction MOSFET	19	99 mΩ	SP3F	YES	MSCC60VRM99CT3AG
		40	45 mΩ	SP6-P	YES	MSCC60VRM45TAPG
		81	23 mΩ	SP4		MSCC60AM23C4AG
650	TRENCH 5	80	1.65	SP1		MSCGTQ100HD65C1AG

R_{DS(on)} value for the MOSFETs in mΩ and V_{CE(on)} value for the IGBTs in Volts

Diode Power Modules

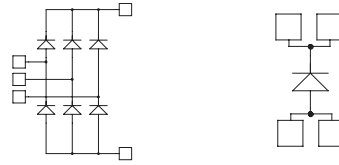

V_{RRM} (V)	Diode Type	I_F (A) $T_c = 80^\circ\text{C}$	V_F (V) $T_c = 80^\circ\text{C}$	Package (see page 24)	Part Number
200	FRED	500	1.1	LP4	APTDF500U20G
400		500	1.5		APTDF500U40G
600		450	1.8		APTDF450U60G
1000		430	2.3		APTDF430U100G
1200		400	2.5		APTDF400U120G

Single Diode

V_{RRM} (V)	Diode Type	I_F (A) $T_c = 80^\circ\text{C}$	V_F (V) $T_J = 25^\circ\text{C}$	Package (see page 24)	Part Number
1600	Rectifier	40	1.3	SP1	APTDR40X1601G
		90	1.3	SP1	APTDR90X1601G

Common Cathode– Common Anode–Doubler

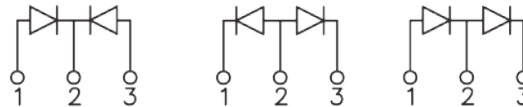

V_{RRM} (V)	Diode Type	I_F (A) per Diode	V_F (V) $T_J = 25^\circ\text{C}$	Package (see page 24)	Common Cathode	Common Anode	Doubler
200	FRED	400	1	SP6	APTDF400KK20G	APTDF400AA20G	APTDF400AK20G
600			1.6		APTDF400KK60G	APTDF400AA60G	APTDF400AK60G
1000			2.1		APTDF400KK100G	APTDF400AA100G	APTDF400AK100G
1200			2.4		APTDF400KK120G	APTDF400AA120G	APTDF400AK120G
1700			2.2		APTDF400KK170G	APTDF400AA170G	APTDF400AK170G

Full Bridge

V_{RRM} (V)	Diode Type	I_F (A) $T_c = 80^\circ\text{C}$	V_F (V) $T_c = 80^\circ\text{C}$	Package (see page 24)	Part Number
200	FRED	30	1	SOT-227	APT30DF20HJ
		60	1	SOT-227	APT60DF20HJ
		100	1	SP4	APTDF100H20G
600		30	1.8	SP1	APTDF30H601G
		30	1.8	SOT-227	APT30DF60HJ
		60	1.8	SOT-227	APT60DF60HJ
		60	1.8	SP1	APTDF60H601G
		100	1.6	SOT-227	APT100DL60HJ
		100	1.6	SP1	APTDF100H601G
1000		200	1.6	SP6	APTDF200H60G
		30	2.1	SOT-227	APT30DF100HJ
		100	2.1	SP4	APTDF100H100G
1200		200	2.1	SP6	APTDF200H100G
		30	2.6	SP1	APTDF30H1201G
		60	2.6	SP1	APTDF60H1201G
	75	1.6	SOT-227	APT75DL120HJ	
1700	200	2.4	SP6	APTDF200H120G	
	50	1.8	SOT-227	APT50DF170HJ	
1600	RECTIFIER	75	1.8	SOT-227	APT75DF170HJ
		40	1.3	SOT-227	APT40DR160HJ
		90	1.3	SOT-227	APT90DR160HJ

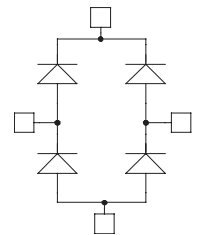

Power Discrete and Module Outlines

TO-220 2-Lead

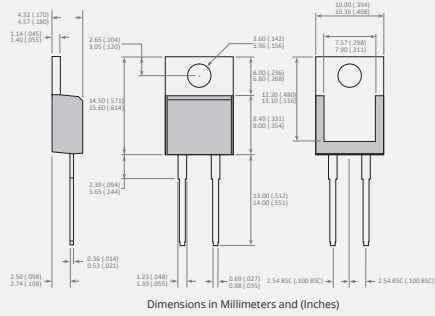

TO-220 3-Lead

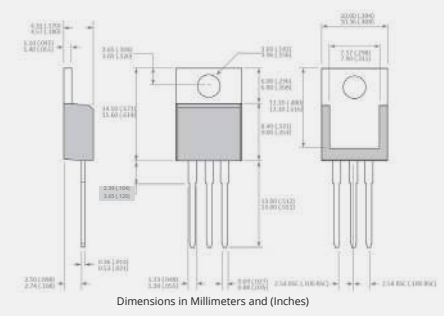

TO-247 2-Lead

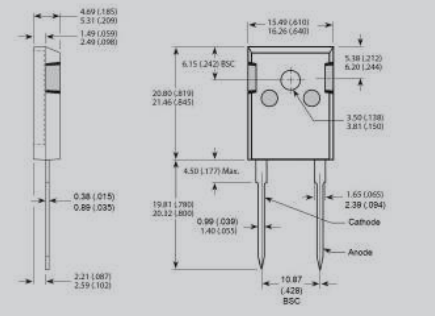

TO-247-3-Lead

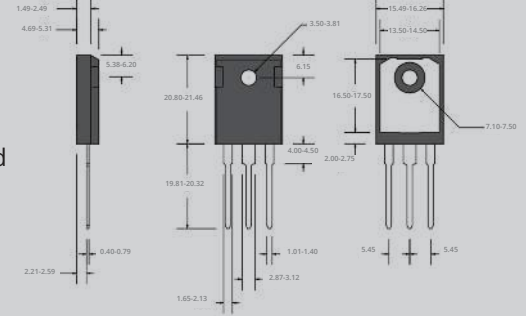

TO-247-4-Lead

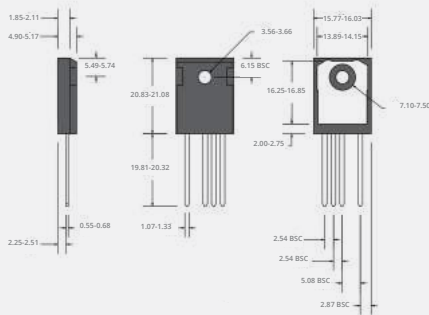

T-MAX®

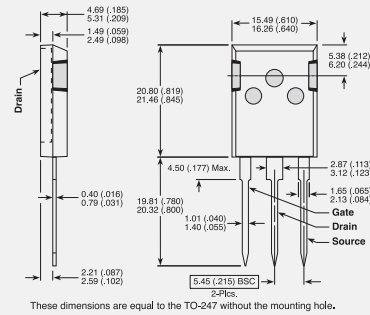

TO-264

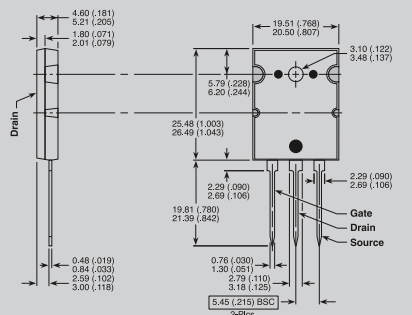

D3PAK or TO-268

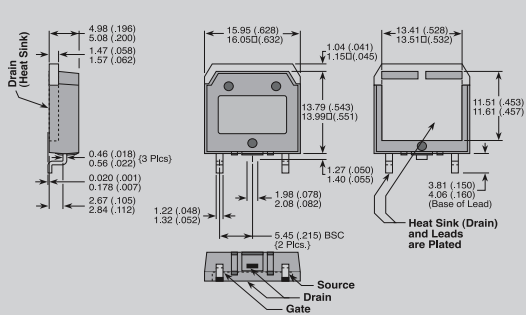

264 MAX™

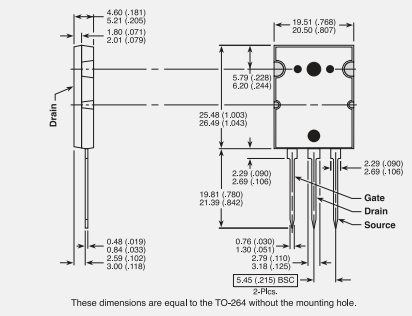

SOT-227

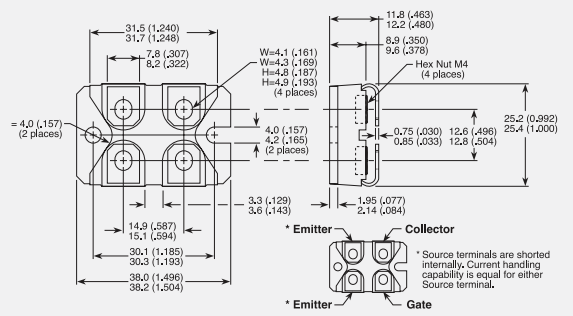

Pinout location depends on the module configuration. Please refer to the product datasheet for pin assignments. All dimensions in millimeters and (inches).

BL1

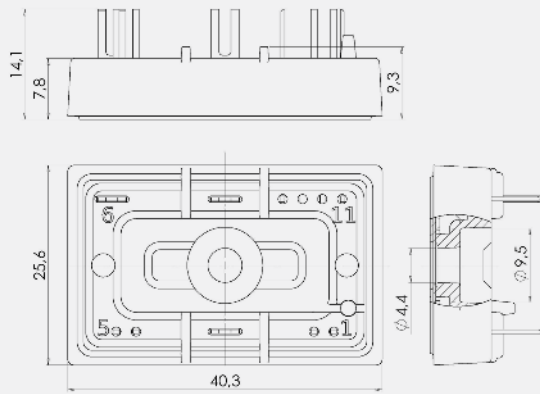

BL2

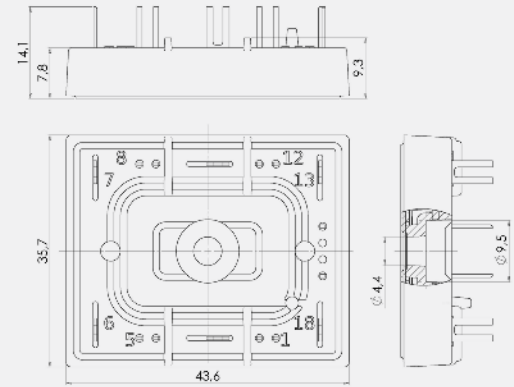

BL3

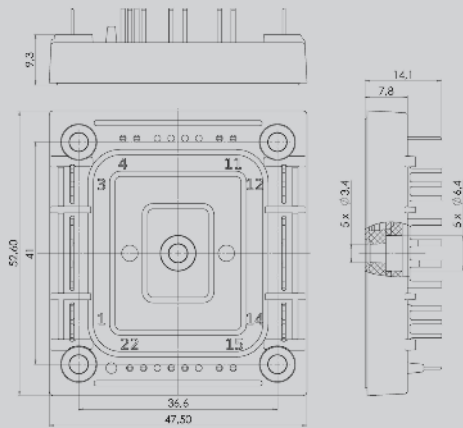

D1P

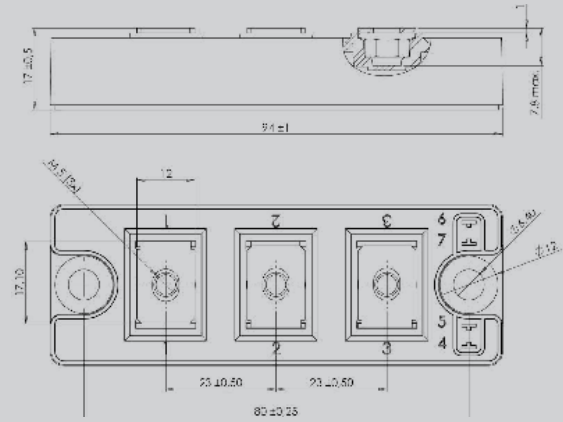

D3

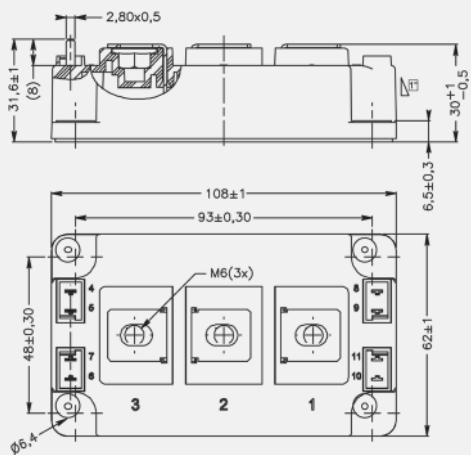

D4

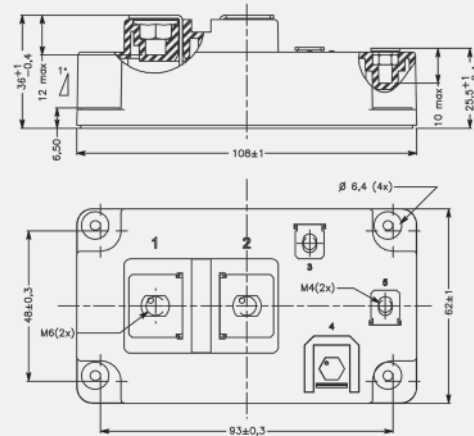

LP4

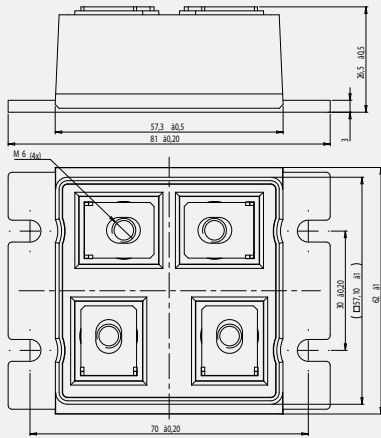

LP8

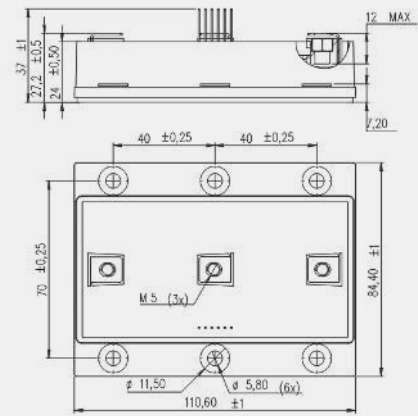

SP1

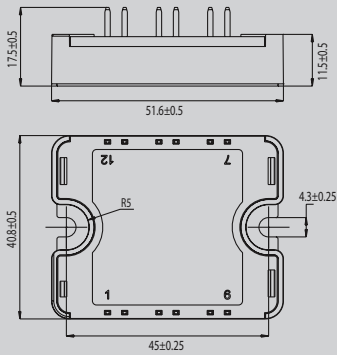

SP1F

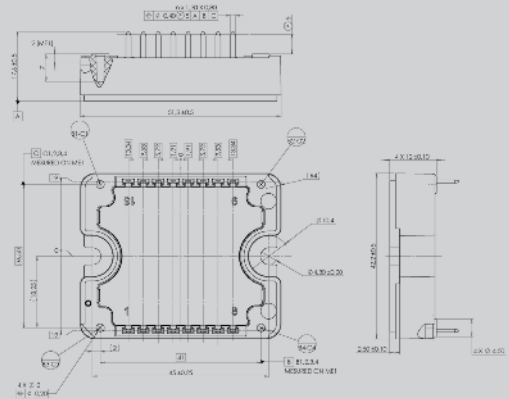

SP3F

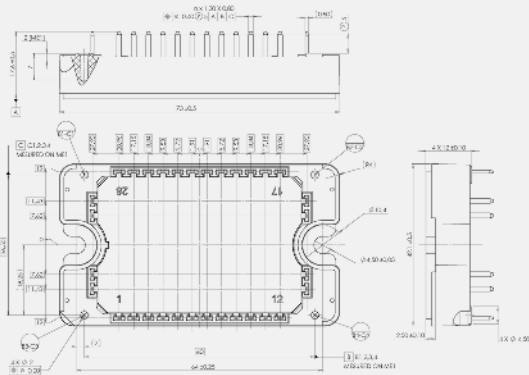

SP4

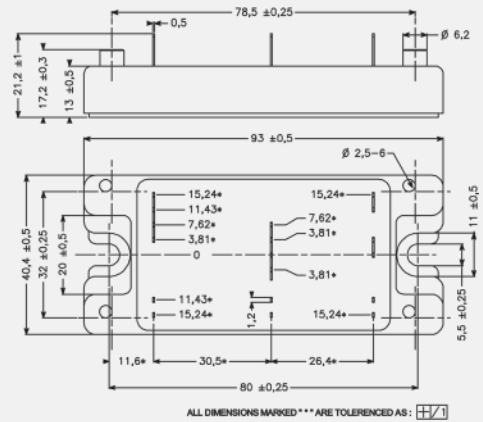

Pinout location depends on the module configuration. Please refer to the product datasheet for pin assignments. All dimensions in millimeters.

SP6-Three Outputs

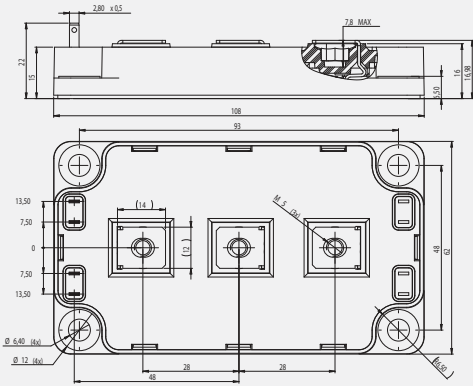

SP6-Four Outputs, Version 1

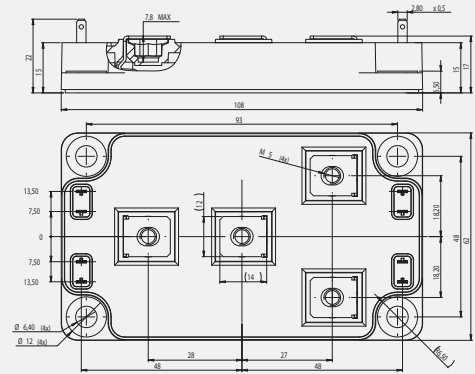

SP6-Four Outputs, Version 2

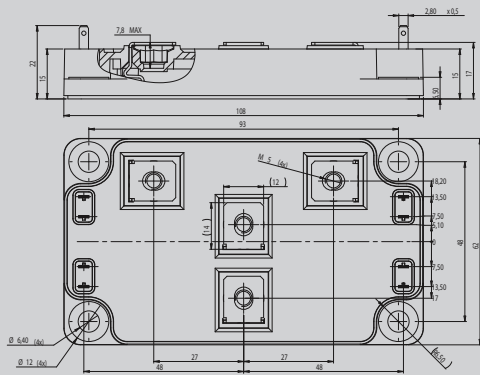

SP6-P

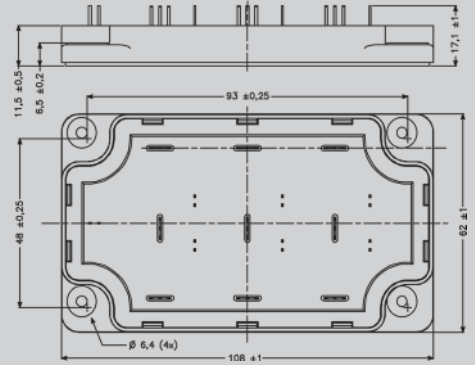

SP6LI

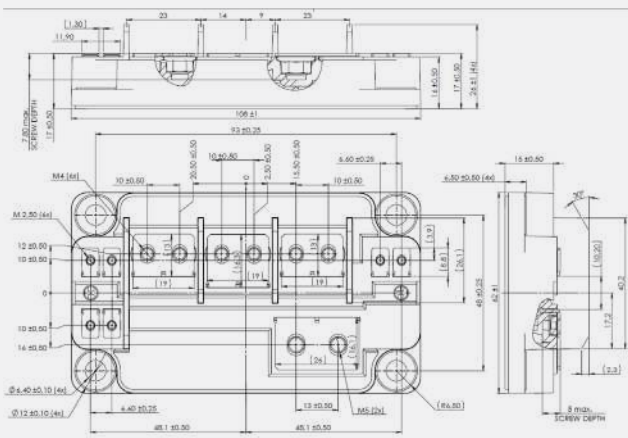

Pinout location depends on the module configuration. Please refer to the product datasheet for pin assignments. All dimensions in millimeters.

AgileSwitch® Configurable Digital Gate Driver Solutions

Development Kit

Microchip's Accelerated Silicon Carbide Development Kits include the hardware and software elements required to rapidly optimize the performance of Silicon Carbide (SiC) modules and systems. This new tool enables designers to adjust system performance through software settings using the AgileSwitch® Intelligent Configuration Tool (ICT) and a Device Programmer. No soldering is required. The ICT offers configuration of different drive parameters including On/Off Gate Voltages, DC Link and Temperature Fault Levels, and Augmented Switching™ profiles. Small changes to the Augmented Switching profiles can yield dramatic improvements in switching efficiency, overshoot, ringing, and short-circuit protection.

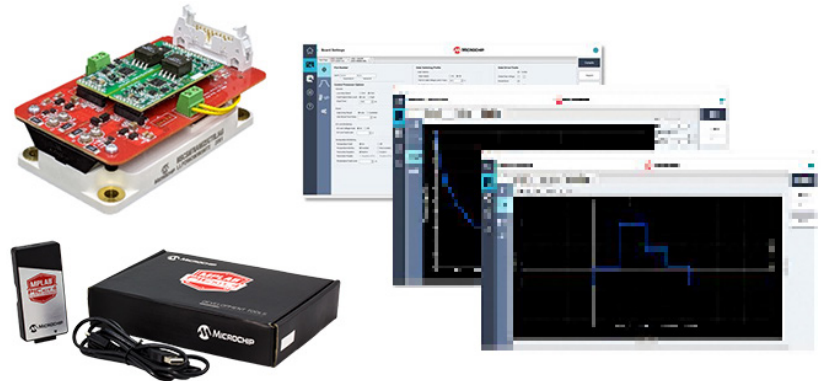

2ASC Configurable Digital Gate Driver Cores

Providing higher performance, lower system cost and faster time to market for your SiC based power systems. Our AgileSwitch 2ASC dual-channel high performance digital gate driver cores incorporate patented Augmented Switching™ technology to reduce EMI Noise in the system, catch short circuit conditions before they become a hazard, reduce thermal losses, control voltage overshoots and control ringing.



Module Adapter Boards

Coupled with our AgileSwitch 2ASC Gate Driver Cores, our Module Adapter Board series provides a platform to rapidly evaluate and optimize new SiC power designs and systems. Standard offerings include a reference design for 1200V/1700 SP6LI (SP6CA1/SP6CA3) and 1200V/1700 D3 (62CA1/62CA4) Microchip SiC Power Modules. Shown are the 62CA1 board coupled with an 2ASC-12A1HP core and the SP6CA1 board.

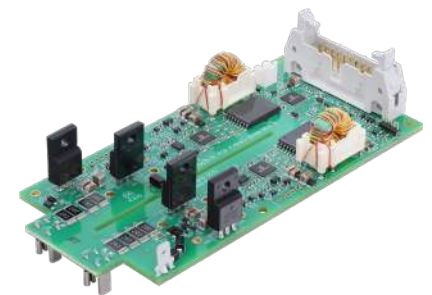

Plug and Play Configurable Digital Gate Driver Boards

Control, monitor and protect the latest 62 mm SiC modules using our Plug and Play 62EM Configurable Digital Gate Driver Boards. Designed for traction applications, the 62EM can drive up to 1.7 kV devices at 100 kHz with configurable fault settings and patented Augmented Switching technology.

Configurable SiC Digital Gate Driver Cores

Part Number	Voltage (V)	Driver Type	Programming Tool	Augmented Switching™	Turn On Voltage Range	Turn Off Voltage Range
2ASC-12A1HP	1200	Dual Channel	ASBK-014	Turn Off	+15V to +20V	-5V to 0V
2ASC-12A2HP	1200	Dual Channel	ASBK-014	Turn On & Off	+15V to +20V	-5V to 0V
2ASC-17A1HP	1700	Dual Channel	ASBK-014	Turn Off	+15V to +20V	-5V to 0V

Module Adapter Boards

Part Number	Voltage (V)	For Module Type	Compatible With Gate Driver Core
62CA1	1200	62 mm, D3, SP6	2ASC-12A2HP / 2ASC-12A1HP
EDCA1	1200	Rohm E/G Type	2ASC-12A2HP / 2ASC-12A1HP
SP6CA1	1200	SP6LI	2ASC-12A2HP / 2ASC-12A1HP
XMCA1	1200	Wolfspeed XM3	2ASC-12A2HP / 2ASC-12A1HP
62CA4	1700	62 mm, D3, SP6	2ASC-17A1HP
SP6CA3	1700	SP6LI	2ASC-17A1HP

Plug and Play Configurable SiC Digital Gate Driver Core

Part Number	Voltage (V)	Driver Type	Programming Tool	Augmented Switching™	Turn On Voltage Range	Turn Off Voltage Range
62EM1-00001	1700	Dual Channel	ASBK-014	Turn Off	Fixed (+20V)	Fixed (-5V)

Digital Gate Driver Developer Kits

Part Number	Voltage (V)	Module Adapter Board	Gate Driver Core	Included SiC MOSFET Power Module
ASDAK-MSCSM70AM025CT6LIAG-01	700	1 x SPCA1	1 x 2ASC-12A1HP	1 x MSCSM70AM025CT6LIAG
ASDAK-2ASC-12A1HP-62	1200	1 x 62CA1	3 x 2ASC-12A1HP	
ASDAK-2ASC-12A1HP-SP6LI	1200	1 x 62CA1	3 x 2ASC-12A1HP	
ASDAK-MSCSM120AM02CT6LIAG-01	1200	1 x SPCA1	1 x 2ASC-12A1HP	1 x MSCSM120AM02CT6LIAG
ASDAK-MSCSM120AM03CT6LIAG-01	1200	1 x SPCA1	1 x 2ASC-12A1HP	1 x MSCSM120AM03CT6LIAG
ASDAK-MSCSM120AM042CT6LIAG-01	1200	1 x SPCA1	1 x 2ASC-12A1HP	1 x MSCSM120AM042CT6LIAG
ASDAK-2ASC-17A1HP-62	1700	1 x 62CA4	3 x 2ASC-17A1HP	

Each Developer Kit Also Includes, PICKit™ Device Programming Kit (ASBK-014), Intelligent Configuration Tool (ICT) Software and cables.

User-Friendly Reference Designs

Microchip and our partner ecosystem provide open-source, user friendly SiC MOSFET reference design solutions that enable faster time to market for customers using our SiC MOSFETs and power modules. You can use isolated dual-gate driver reference designs with our SiC MOSFETs in a number of SiC topologies.

SiC Solutions

Part Number	Gate Drive or Line Voltage	kHz, max	Per Side Drive Power (W)	Description
MSCSICPFC/REF5	In: 400 Vrms, Out: 700 Vdc	140	30 kW	30 kW 3-phase Vienna PFC (design files only)

The MSCSICPFC/REF5 is a Vienna 3-Phase PFC reference design for Hybrid Electric Vehicle/Electric Vehicle (HEV/EV) charger and high-power switch mode power supply applications.

- 30 kW Vienna rectifier topology at 98.6 % peak efficiency
- 380/400 VAC, 50 Hz/60 Hz input voltage with 700V DC output voltage
- 140 kHz pulse-width modulation switching frequency
- < 5% current THD at half and full loads
- 700V SiC MOSFETs and 1200V SiC diodes
- dsPIC33CH using 3-level modulation for digital control
- Includes Microchip linear op amps, voltage regulators and CAN FD-ready transceiver



Simulation Models

Microchip offers a variety of simulation tools that help designers lower design complexities and shorten design cycle times. Both device and system level tools are available for use in device evaluation, system development and scaling of existing system level models.

- **MPLAB® Mindi™ Analog Simulator**
 - Brief Description: Free SPICE circuit simulation tool that uses a SIMetrix/SIMPLIS simulation environment.
 - What's available: Free MPLAB Mindi Analog Simulator download. SiC Models are available for the 700V, 1200V and 1700V SiC MOSFETs and Schottky Barrier Diodes
 - Relevant links: Simulation tool download at microchip.com/mplab/mplab-mindi and SiC models at microchip.com
- **SPICE**
 - Brief Description: SPICE is a widely used circuit simulator that provides the ability to evaluate a device within a circuit design. SPICE models support this simulation work by designers.
 - What's available: Microchip provides SPICE models for all of its newest SiC Schottky Barrier Diodes and SiC MOSFETs in 700V, 1200V, and 1700V
 - Relevant links: microchip.com
- **PLECS**
 - Brief Description: PLECS models provide device switching and conduction losses as well as thermal characterization for use in PLECS multi-domain simulations.
 - What's available: Vienna 3-Phase Power Factor Correction (PFC) Reference Design PLECS simulation model
 - Relevant links: microchip.com
 - microchip.com/plecs

MPLAB® Mindi™ SPICE Circuit Simulation Model

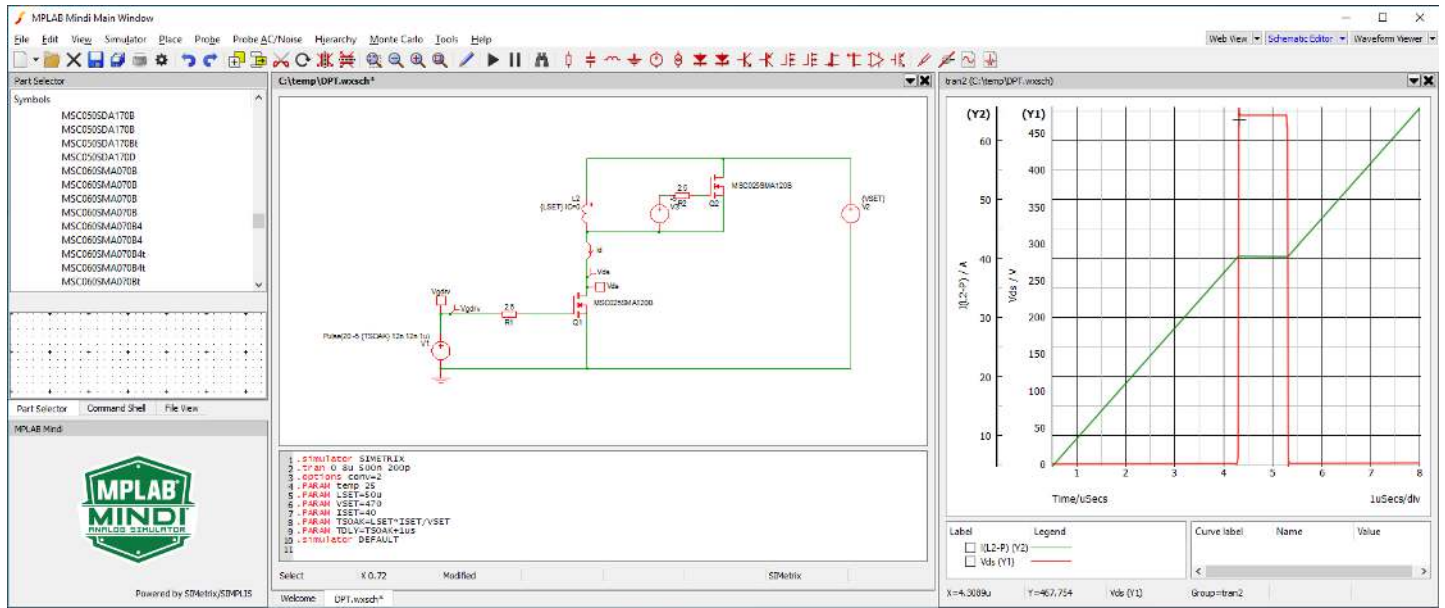

PLECS Simulation Model for 30 kW Vienna PFC

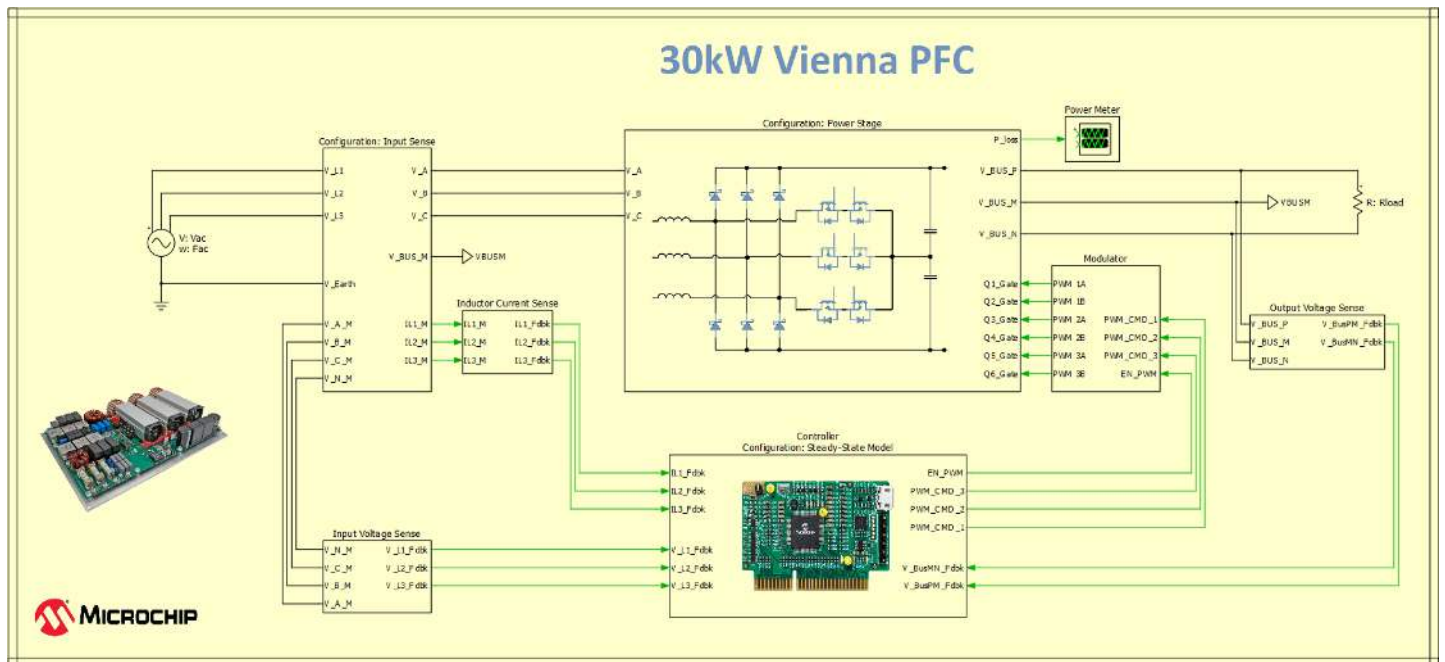



Support

Microchip is committed to supporting its customers in developing products faster and more efficiently. We maintain a worldwide network of field applications engineers and technical support ready to provide product and system assistance. For more information, please visit www.microchip.com:

Technical Support: www.microchip.com/support

Evaluation samples of any Microchip device:
www.microchip.com/sample

Knowledge base and peer help:
www.microchip.com/forums

Sales and Global Distribution: www.microchip.com/sales



Training

If additional training interests you, Microchip offers several resources including in-depth technical training and reference material, self-paced tutorials and significant online resources.

Overview of Technical Training Resources:
www.microchip.com/training

Microchip University:
www.microchip.com/mu

Developer Help Website:
www.microchip.com/developerhelp

Technical Training Centers:
www.microchip.com/seminars

Microchip Technology Inc. | 2355 W. Chandler Blvd. | Chandler AZ, 85224-6199 | microchip.com