

Evaluating the **AD5413** Single-Channel, 14-Bit Current and Voltage Output DAC with HART Connectivity

FEATURES

Fully featured evaluation board for the **AD5413**
On board 2.5 V **ADR4525** reference
ACE software for control

EVALUATION KIT CONTENTS

EVAL-AD5413SDZ

EQUIPMENT NEEDED

SDP-S controller board
Bench top power supply and connector cables
PC or laptop

DOCUMENTS NEEDED

AD5413 data sheet
ACE user manual

SOFTWARE NEEDED

ACE software

GENERAL DESCRIPTION

This user guide describes the EVAL-AD5413SDZ for the **AD5413** single-channel, 14-bit voltage and 14-bit current output digital-to-analog converter (DAC).

The EVAL-AD5413SDZ (see Figure 1) requires the **EVAL-SDP-CS1Z** system demonstration platform (**SDP-S**) board. The EVAL-AD5413SDZ interfaces to the USB port of the PC via the **SDP-S** board. The **Analysis, Control, Evaluation (ACE)** software allows simplified programming of the **AD5413**, and is available to use with the EVAL-AD5413SDZ.

For full details on the **AD5413**, see the **AD5413** data sheet. Consult the data sheet in conjunction with this user guide when using the EVAL-AD5413SDZ.

EVALUATION BOARD PHOTOGRAPH

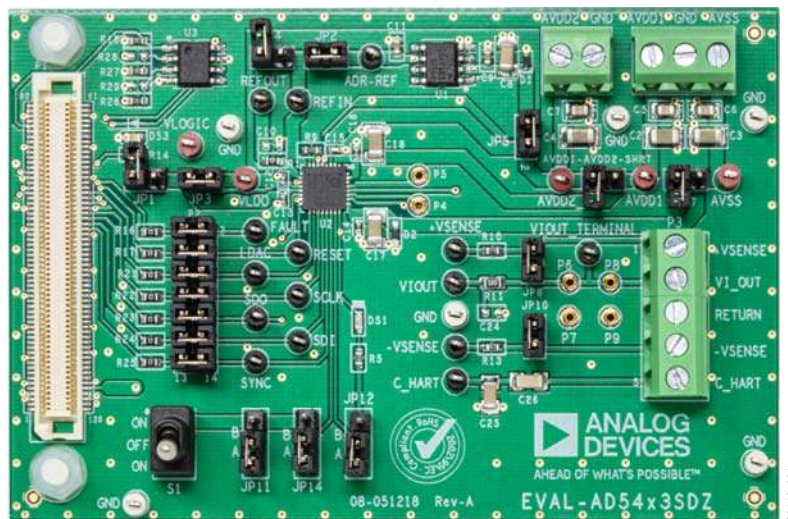

Figure 1.

TABLE OF CONTENTS

Features	1	Initial Setup	4
Evaluation Kit Contents.....	1	AD5413 Block Diagram and Functions	6
Equipment Needed.....	1	Initial Configuration.....	8
Documents Needed.....	1	Setting the DAC Output	8
Software Needed	1	Updating Diagnostic Results	8
General Description	1	Example Sequences	8
Evaluation Board Photograph.....	1	ACE Tool Views.....	10
Revision History	2	Macro Tool	10
Evaluation Board Hardware.....	3	Register Debugger Tool	10
Power Supplies	3	Events Tool	10
Serial Communication.....	3	Evaluation Board Schematics and Artwork.....	11
AD5413 Device Address Pins	3	Ordering Information.....	16
Software Quick Start Procedures.....	4	Bill of Materials.....	16
Installing the ACE Software and EVAL-AD5413SDZ Plugins	4		

REVISION HISTORY

5/2020—Revision 0: Initial Version

EVALUATION BOARD HARDWARE

POWER SUPPLIES

The EVAL-AD5413SDZ requires a number of power supply inputs for the AV_{DD1}, AV_{DD2}, AV_{SS}, and V_{LOGIC} pins on the AD5413. If there is only one positive rail available, connect the AV_{DD2} pin to the AV_{DD1} pin via the AVDD1-AVDD2-SHRT link on the EVAL-AD5413SDZ. Select the V_{LOGIC} supply from the 3.3V_{SDP} net on the SDP-S board or the V_{LDO} pin, through the JP1 and JP3 jumpers. See Table 1 for more link options and the default link positions.

The EVAL-AD5413SDZ operates with a power supply range from -33 V on AV_{SS} to +33 V on AV_{DD1} with a maximum voltage of 50 V between the two rails. AV_{DD2} requires a voltage between 4.5 V and 33 V. In a typical operating condition, AV_{DD2} = +5 V, AV_{DD1} = +24 V, and AV_{SS} = -24 V.

SERIAL COMMUNICATION

The SDP-S board handles the communication to the EVAL-AD5413SDZ via the PC. By default, the SDP-S board handles the serial port interface (SPI) communication, controls the RESE \overline{T} pin and the LDAC pin, and monitors the FAULT pin of the AD5413.

The EVAL-AD5413SDZ can disconnect from the SDP-S board and drive the digital signals from an external source by removing the appropriate links on P2 (see Table 2). An option to tie the RESE \overline{T} pin and the LDAC pin to high or low levels is available through the S1 switch and the JP11 link.

AD5413 DEVICE ADDRESS PINS

Use the device address pins (AD0 and AD1) in conjunction with the device address bits within the SPI frame to determine which AD5413 device is addressed by the system controller. The AD0 pin and the AD1 pin can be configured through the JP12 and JP14 links (see Table 1).

Table 1. EVAL-AD5413SDZ Link Option Functions

Link	Default Position	Function
AVDD1-AVDD2-SHRT	Not inserted	Connects the AV _{DD2} pin to the AV _{DD1} pin.
JP1	Not inserted	Selects 3.3 V from the SDP-S as the source for V _{LOGIC} pin.
JP2	Inserted	Selects the external reference, ADR-REF, as the input to REFIN.
JP3	Inserted	Selects 3.3 V from the V _{LDO} pin of the AD5413 as the source for the V _{LOGIC} pin.
JP4	Not inserted	Selects REFOUT as the input to REFIN.
JP5	Inserted	Powers ADR-REF from the AV _{DD2} pin (the maximum supply for the ADR4525 is 15 V).
JP8	Inserted	Connects the V _{OUT} pin to the +V _{SENSE} pin.
JP10	Inserted	Connects the -V _{SENSE} pin to the RETURN signal on the EVAL-AD5413SDZ.
JP11	A	Position A connects the LDAC pin to the ground position. Position B connects the LDAC pin to the V _{LOGIC} pin.
JP12	A	Position A connects the AD0 pin to the ground position. Position B connects the AD0 pin to the V _{LOGIC} pin.
JP14	A	Position A connects the AD1 pin to the ground position. Position B connects the AD1 pin to the V _{LOGIC} pin.
JP17	Not inserted	Connects the AV _{SS} pin to the ground position pin for the unipolar supply option (current output only).
P2	Inserted	Provides options to disconnect from the SDP-S board and to drive digital signals from an external source.
S1	Up	In the up position, this link connects the RESE \overline{T} pin to the V _{LOGIC} pin.
	Middle (default)	In the middle position (default), this link controls the RESE \overline{T} pin via the SDP-S board.
	Down	In the down position, this link connects the RESE \overline{T} pin to the ground position pin.

Table 2. Link Options for P2 Header

Pin No.	Position	Function
1, 2	Inserted	Connects the FAULT signal from the SDP-S board to the FAULT pin on the AD5413.
	Not inserted	Disconnects the FAULT signal from the SDP-S board to the FAULT pin on the AD5413.
3, 4	Inserted	Connects the RESE \overline{T} signal from the SDP-S board to the RESE \overline{T} pin on the AD5413.
	Not inserted	Disconnects the RESE \overline{T} signal from the SDP-S board to the RESE \overline{T} pin on the AD5413.
5, 6	Inserted	Connects the LDAC signal from the SDP-S board to the LDAC pin on the AD5413.
	Not inserted	Disconnects the LDAC signal from the SDP-S board to the LDAC pin on the AD5413.
7, 8	Inserted	Connects the SCLK signal from the SDP-S board to the SCLK pin on the AD5413.
	Not inserted	Disconnects the SCLK signal from the SDP-S board to the SCLK pin on the AD5413.
9, 10	Inserted	Connects the SDO signal from the SDP-S board to the SDO pin on the AD5413.
	Not inserted	Disconnects the SDO signal from the SDP-S board to the SDO pin on the AD5413.
11, 12	Inserted	Connects the SDI signal from the SDP-S board to the SDI pin on the AD5413.
	Not inserted	Disconnects the SDI signal from the SDP-S board to the SDI pin on the AD5413.
13, 14	Inserted	Connects the SYNC signal from the SDP-S board to the SYNC pin on the AD5413.
	Not inserted	Disconnects the SYNC signal from the SDP-S board to the SYNC pin on the AD5413.

SOFTWARE QUICK START PROCEDURES INSTALLING THE ACE SOFTWARE AND EVAL-AD5413SDZ PLUGINS

The EVAL-AD5413SDZ board uses Analog Devices, Inc., ACE software. For instructions on how to install and use the ACE software, go to www.analog.com/ACE.

When the installation is finished, the EVAL-AD5413SDZ plugin appears when the ACE software is opened.

INITIAL SETUP

To set up the EVAL-AD5413SDZ, take the following steps:

1. Connect a USB cable to the PC and then to the SDP-S board.
2. Connect the SDP-S board to the EVAL-AD5413SDZ. The PC recognizes the EVAL-AD5413SDZ.
3. Power up the EVAL-AD5413SDZ with the power supplies recommended in the Power Supplies section.
4. Open the ACE software. The EVAL-AD5413SDZ appears in the **Attached Hardware** pane of the ACE window.
5. When setting up the EVAL-AD5413SDZ for the first time, you may be required to install the EVAL-AD5413SDZ plugin. If the plugin appears as shown in Figure 2, proceed to Step 7. If the plugin appears as shown in Figure 3, double-click the evaluation board symbol, and the pop-up window shown in Figure 4 appears. Click **Yes**.

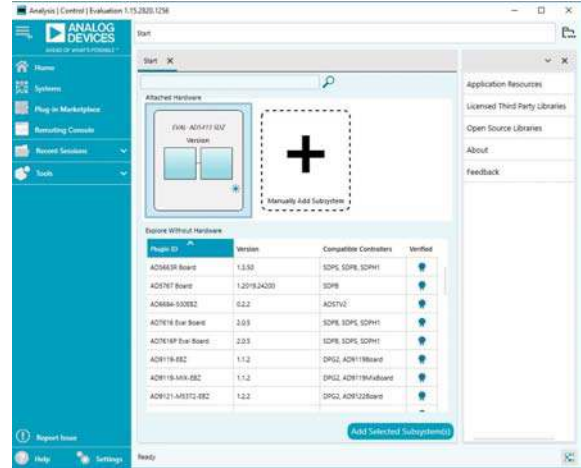

Figure 3. EVAL-AD5413SDZ Plugin Not Installed

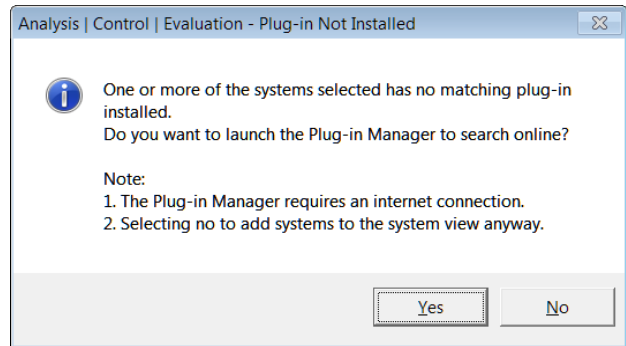

Figure 4. Installing the Plugin Pop-Up Window

6. The plugin manager window appears, as shown in Figure 5.

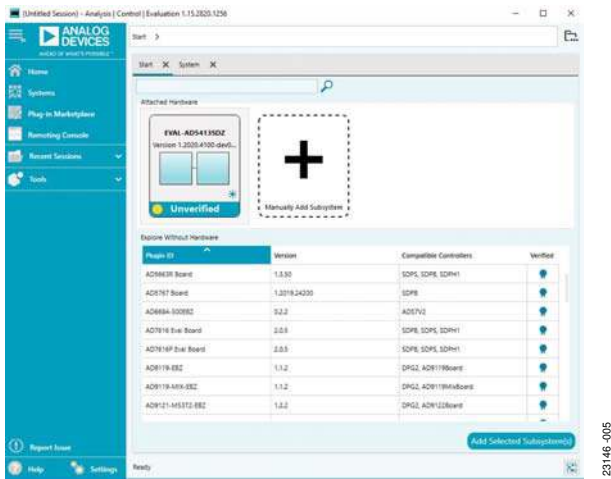

Figure 2. Attached Hardware Section with the EVAL-AD5413SDZ Plugin Connected

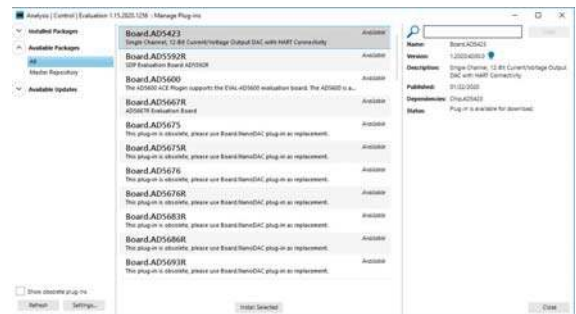

Figure 5. Plugin Manager Window

7. Find and select the **Board.AD5413** plugin and click **Install Selected**. The EVAL-AD5413SDZ plugin is now installed and displays as shown in Figure 2. In Figure 5 only, the **AD5413** is synonymous with the **AD5423**.
8. Double-click **EVAL-AD5413SDZ** to open the **AD5413** block diagram (see Figure 7). The **INITIAL CONFIGURATION** window appears on the left side of the ACE window. Several register settings can be configured in this pane and are written to the device in the appropriate order. The **RESET_OCCURED** and **CAL_MEM_UNREFRESHED** LED indicators in the **DIGITAL DIAGNOSTIC RESULTS** section are illuminated red by default (see Figure 7).

- Write the initial configuration values to clear these error flags. If the device is power cycled, or if the USB cable is disconnected and reconnected while the ACE software is open, contact with the EVAL-AD5413SDZ is lost. To regain contact, click the **System** tab, click the USB symbol on the SDP-S, and then click **Acquire** (see Figure 6).

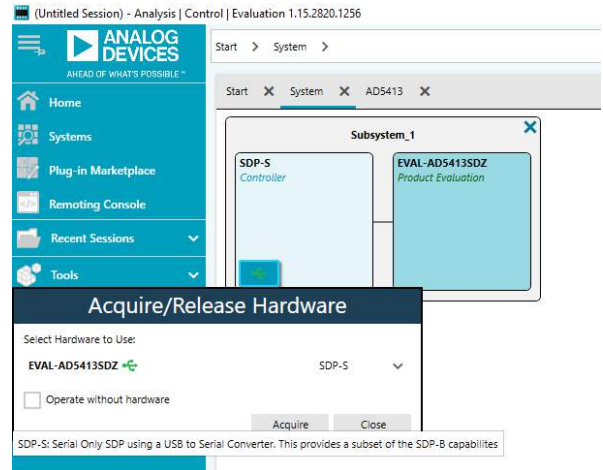

Figure 6. Reconnecting the USB

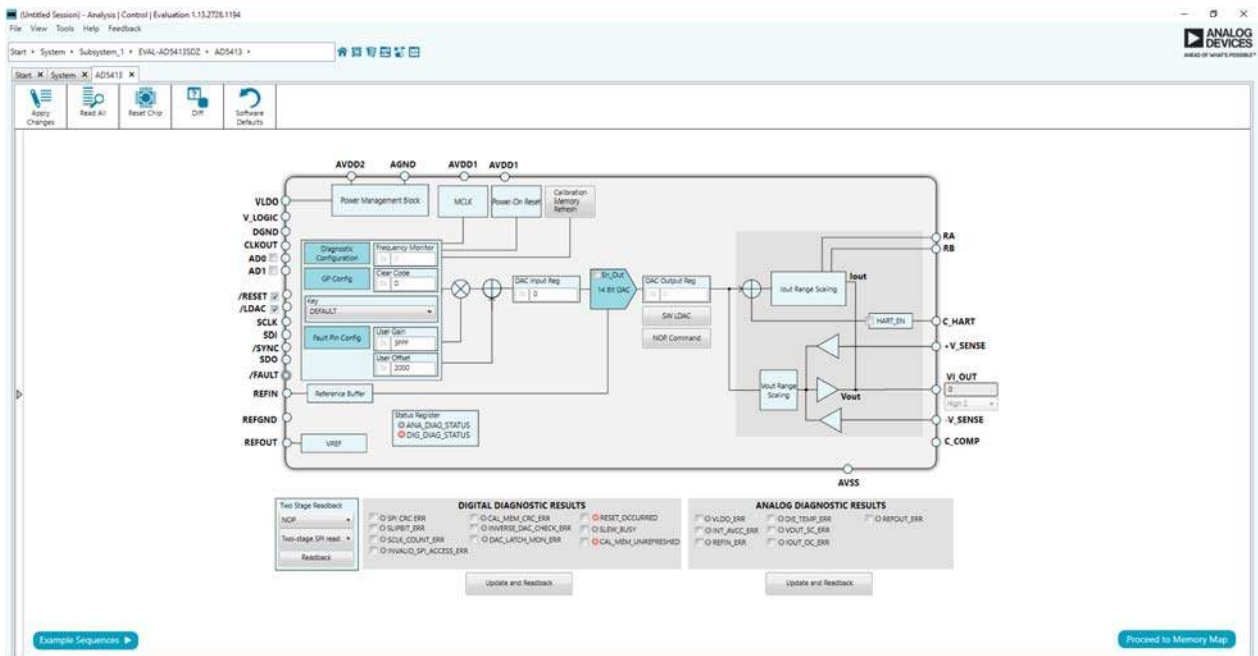

Figure 7. AD5413 Block Diagram in the ACE Software

AD5413 BLOCK DIAGRAM AND FUNCTIONS

The EVAL-AD5413SDZ plugin is organized to appear similar to the block diagram shown in the [AD5413](#) data sheet. This graphical user interface (GUI) correlates the functions of the EVAL-AD5413SDZ with the descriptions in the [AD5413](#) data sheet.

Full descriptions of each block and register setting are available in the [AD5413](#) data sheet. The full screen [AD5413](#) block diagram with labels is shown in Figure 8. Table 3 and Table 4 describe the functionality of each block.

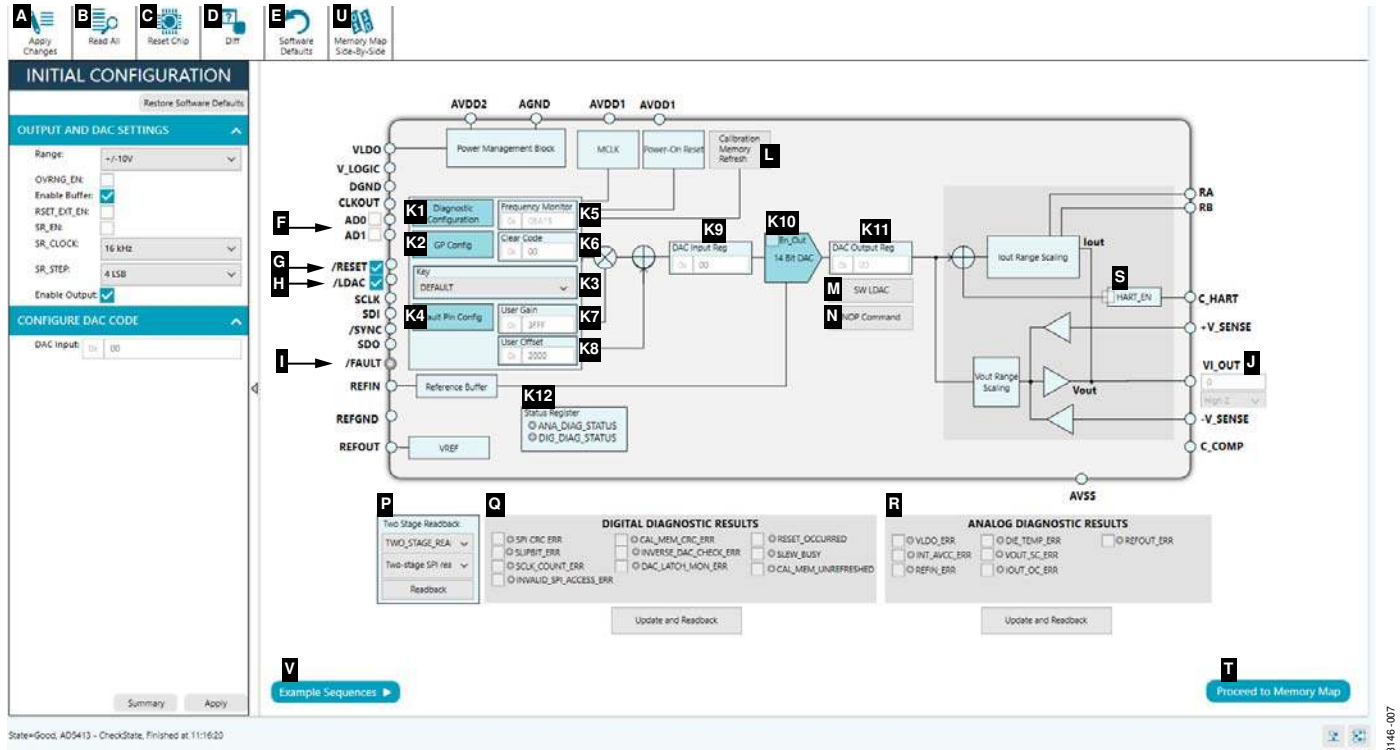

Figure 8. AD5413 Block Diagram with Labels

Table 3. AD5413 Block Diagram Label Functions (See Figure 8)

Figure Label	Function
A	To apply any changes made to the block diagram or to register values in the memory map to the device, click Apply Changes .
B	To read back all of the registers of the device, click Read All .
C	Click Reset Chip to reset the AD5413 . The Reset Chip button has the same functionality as the software reset of the AD5413 .
D	Click Diff to show the registers that are different from the data stored on the device. This function shows what has changed since the last register read.
E	Click Software Defaults to load the software defaults of the device. These values are not written to the hardware. Click Apply Changes (Label A) to write the software default values to the hardware.
F	The AD0 and AD1 check boxes set the AD5413 address of the device and must correspond to the JP12 and JP14 links on the hardware. If either check box is selected, this represents a high state. If either box is not selected, this represents a low state.
G	If the /RESET check box is selected, the SDP-S board sets the $\overline{\text{RESET}}$ pin high. Otherwise, the SDP-S board pulls the $\overline{\text{RESET}}$ pin low.
H	If the /LDAC check box is selected, the SDP-S board sets the $\overline{\text{LDAC}}$ pin high. Otherwise, the SDP-S board pulls the $\overline{\text{LDAC}}$ pin low.
I	The EVAL-AD5413SDZ plugin monitors the FAULT pin. If the FAULT pin is low, the /FAULT indicator LED lights up red.
J	V_IOUT displays the calculated output at V_{OUT} , and displays if the output is in voltage, milliamps, or is high impedance (high-Z).
Kx	GUI access on several registers. Pop-ups, dropdown menus, and hexadecimal text boxes are available in the GUI to configure several registers of the AD5413 . To write the changes to the device, click Apply Changes (Label A). The functions within this GUI that control various registers are described in Table 4.
L	The Calibration Memory Refresh button initiates a write to the key register to perform a calibration memory refresh.
M	The SW LDAC button initiates a write to the key register to perform a software $\overline{\text{LDAC}}$ command.
N	The NOP Command button initiates a write to Address 0x00 for a no operation (NOP) command.
O	Two Stage Readback menu. A 2-stage readback is initiated through the 2-stage readback select register. Click Readback to initiate a write to the 2-stage readback select register and issue a NOP command.

Figure Label	Function
P	DIGITAL DIAGNOSTIC RESULTS menu. Click Update and Readback to trigger a write 1 to clear operation on the selected check boxes and a readback from the digital diagnostic result register.
Q	ANALOG DIAGNOSTIC RESULTS menu. Click Update and Readback to trigger a write 1 to clear operation on the selected check boxes and a readback from the analog diagnostic result register.
R	When the HART_EN check box is selected, the HART_EN bit = 1 in the General-Purpose Configuration 1 register.
S	Click Proceed to Memory Map to open the AD5413 memory map (see Figure 9).
T	Click Memory Map Side-By-Side to open the AD5413 memory map next to the block diagram.
U	Click Example Sequences to open the example sequences window (see Figure 13).

Table 4. Register Controls Accessible via the GUI (See Label Kx in Table 3 and in Figure 8)

Figure Label	Function
K1	Diagnostic Configuration. Click this button to activate the associated pop-up menu.
K2	GP Config. When this button is clicked, a pop-up menu appears to configure the general-purpose configuration registers.
K3	Key register dropdown menu. Use this dropdown menu to configure the key register.
K4	Fault Pin Config. When this button is clicked, a pop-up menu appears to configure the general-purpose configuration registers.
K5	Frequency Monitor menu. This menu displays the value in the frequency monitor when read.
K6	Clear Code menu. In this menu, use the text box to insert a clear code value in hexadecimal format.
K7	User Gain menu. In this menu, use the text box to insert a user gain value in hexadecimal format.
K8	User Offset menu. In this menu, use the text box to insert a user offset value in hexadecimal format.
K9	DAC Input Reg menu. In this menu, use the text box to insert the DAC value in hexadecimal format.
K10	14 Bit DAC. When this button is clicked, a pop-up menu appears to configure the general-purpose configuration registers.
K11	DAC Output Reg. This menu displays the hexadecimal value currently set in the DAC output register.
K12	Status Register. This menu displays the contents of the status register.

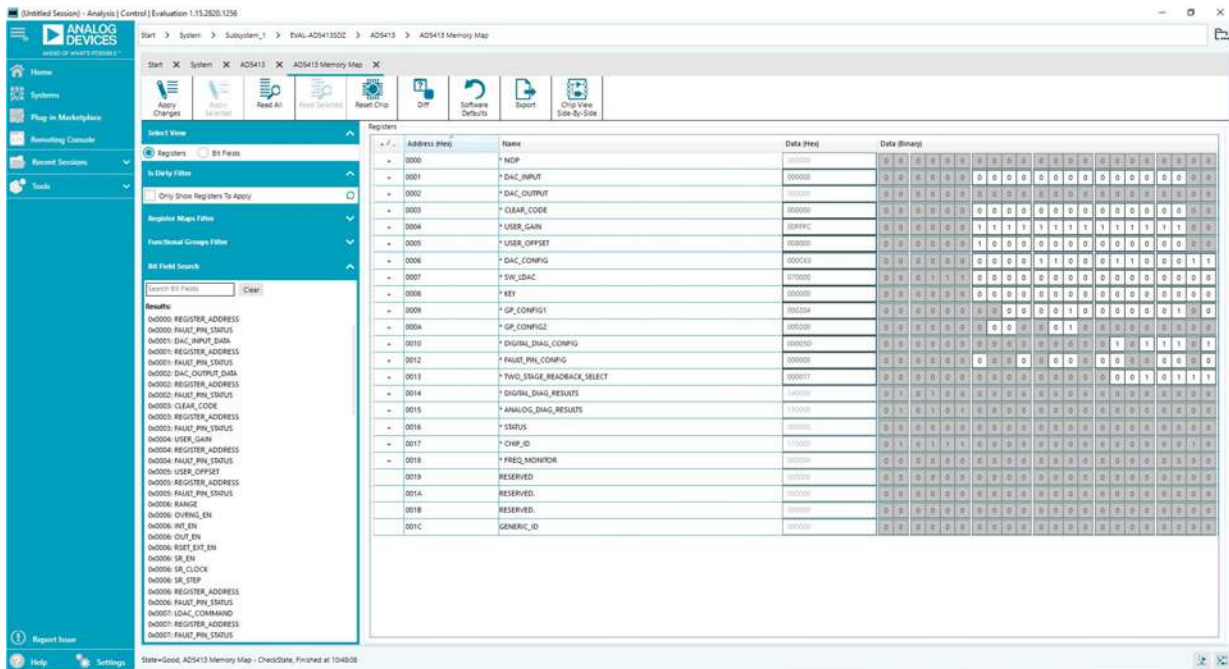

Figure 9. AD5413 Memory Map in the ACE Software

INITIAL CONFIGURATION

An initial configuration wizard is available when the AD5413 plugin opens that allows quick configuration of the AD5413, the DAC configuration register, and the DAC input register. Click **Apply** to initiate the configured settings in the order of the recommended power-up sequence on the AD5413 data sheet.

SETTING THE DAC OUTPUT

To configure the DAC output, use the **DAC Config Register** pop-up menu (see Figure 10). Click the **14 Bit DAC** button in the block diagram (see Figure 8) to display the DAC configuration register. Select the appropriate settings and click **Apply Changes** (see Figure 8). It is recommended to disable the output until the proper value in the DAC input register is written to the device.

To change the DAC voltage or current output level, write the appropriate hexadecimal code to the DAC input register and click **Apply Changes**. Click **SW LDAC** to issue a software LDAC command or pull the LDAC pin low to update the DAC output register with the values in the DAC input register. To enable the DAC output, select the **OUT_EN (Enable VI_OUT)** check box and click **Apply Changes**. The programmed voltage or current then reflects on the VI_{OUT} pin.

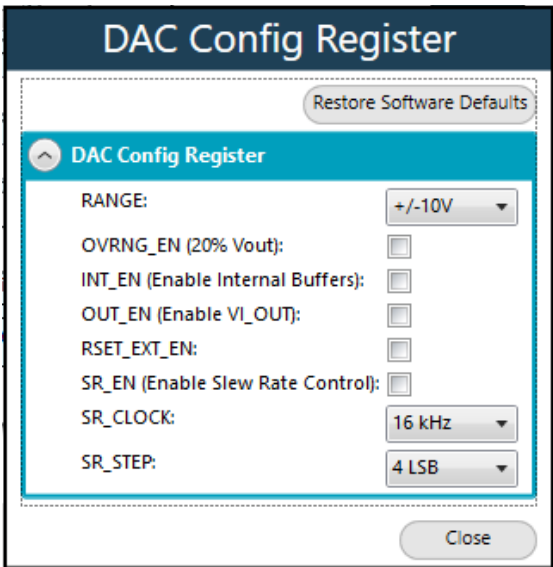

Figure 10. AD5413 DAC Config Register Pop-Up Menu

UPDATING DIAGNOSTIC RESULTS

The AD5413 has a digital diagnostic results register and an analog diagnostic results register that contain error flags for the on-chip digital and analog diagnostic features. Write 1 to the respective error flags to update the error flag status.

To update the digital and analog diagnostic result registers, click **Update and Readback** (see Figure 11 and Figure 12). The **Update and Readback** button initiates a write of 1 to the selected check boxes and then reads back the updated diagnostic result. Figure 11 shows the digital diagnostic results register. Figure 12 shows the analog diagnostic results register.

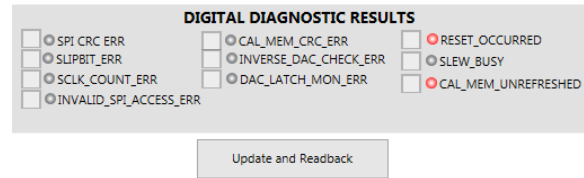

Figure 11. AD5413 Digital Diagnostic Results Register

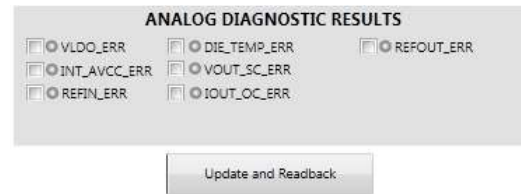

Figure 12. AD5413 Analog Diagnostic Results Register

EXAMPLE SEQUENCES

There are four example sequences available. Click the **Example Sequences** button on the bottom left of the block diagram (see Figure 8) and the window shown in Figure 13 opens. To enable either of the sequences, click the relevant sequence button. The sequence runs immediately and the output changes accordingly. To return to the main window, click **Back to AD5413**.

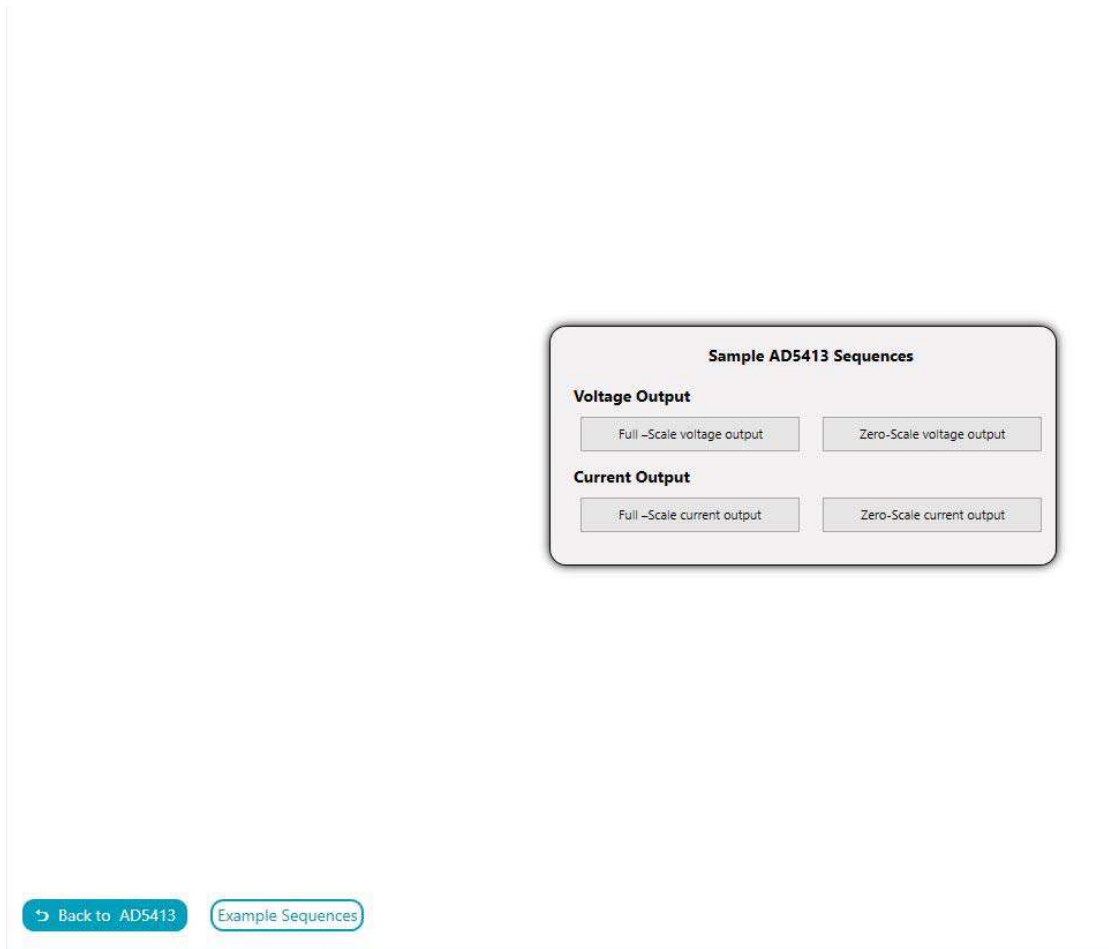

Figure 13. Example Sequences Window

23146-013

ACE TOOL VIEWS

The [ACE](#) software provides additional functionality to the main view described in this user guide. Open these views from the view menu item on the application toolbar. [ACE](#) features a macro tool, a register debugger tool, and an events tool.

MACRO TOOL

The macro tool allows commands to be recorded and saved as an [ACE](#) macro file. This feature is useful when sharing macros with other users to perform the same task multiple times. The user can import and run an [ACE](#) macro file.

REGISTER DEBUGGER TOOL

Use the register debugger tool to perform raw writes to and reads from the device. The register debugger affects only the hardware and does not write to the memory map of [ACE](#).

EVENTS TOOL

The events tool view contains a list of errors, warnings, and information messages generated within the application software.

EVALUATION BOARD SCHEMATICS AND ARTWORK

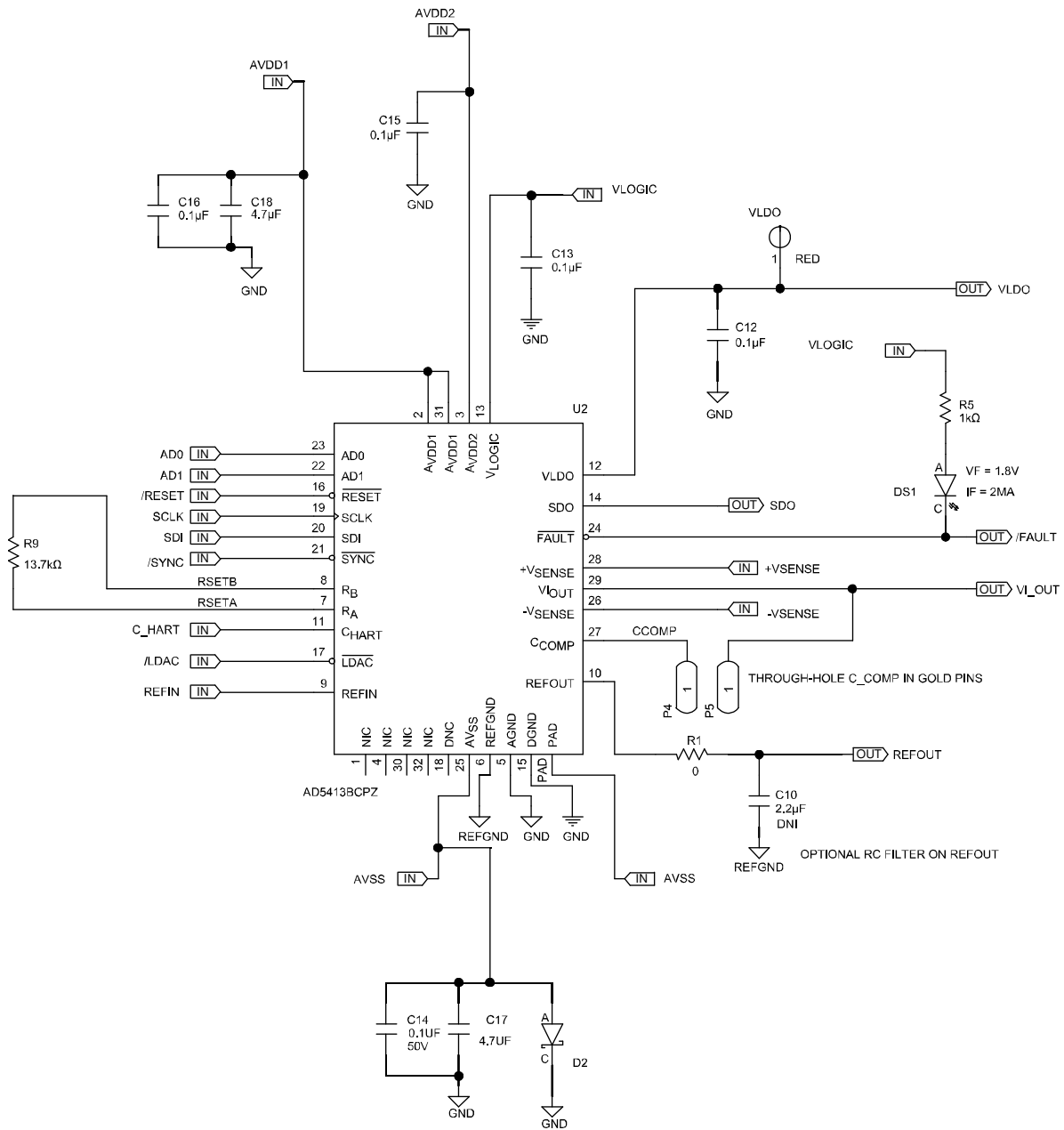

Figure 14. AD5413 Device Schematic

23146-014

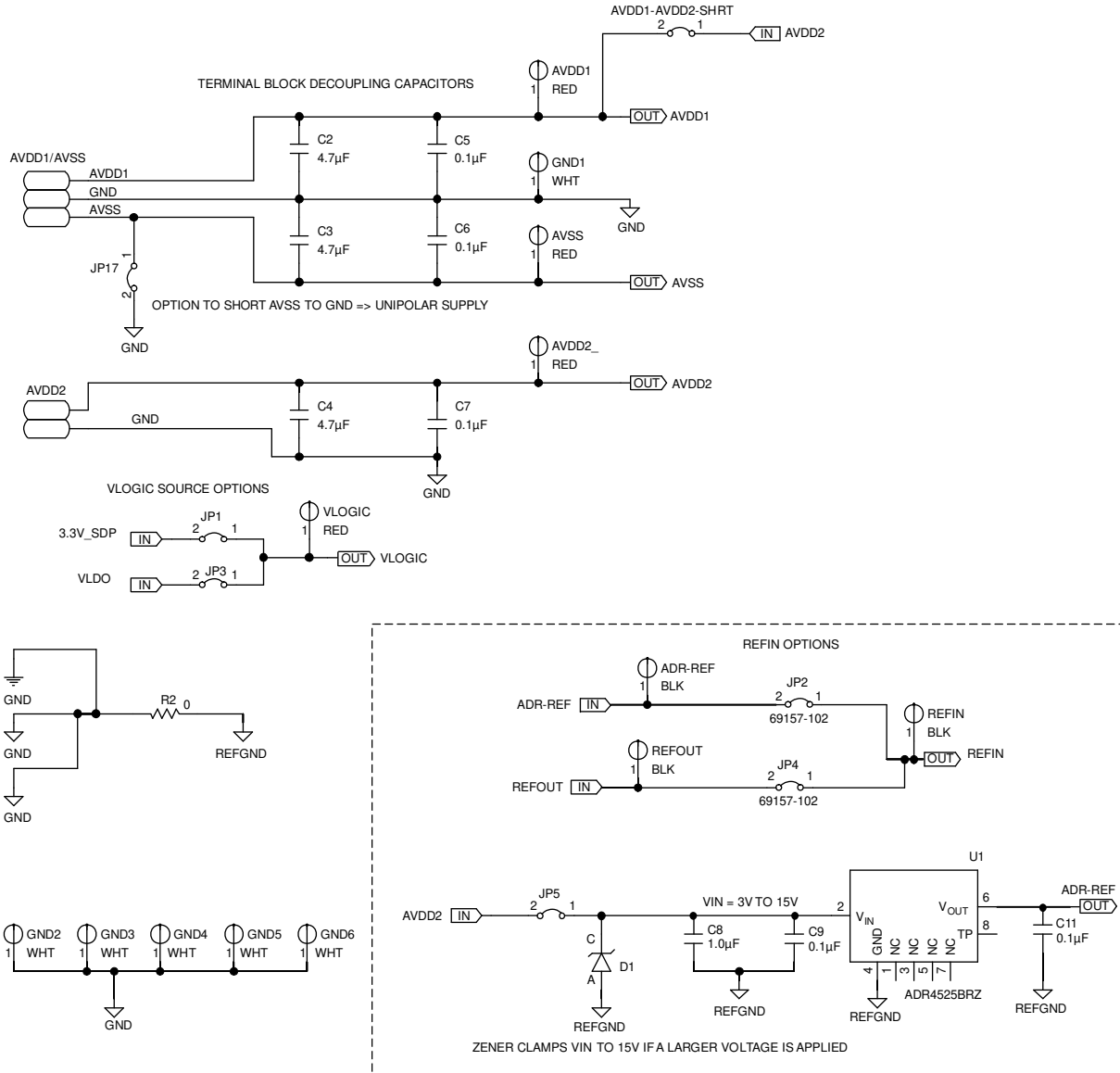

Figure 15. AD5413 Supplies and Reference Options

23146-015

23146-018

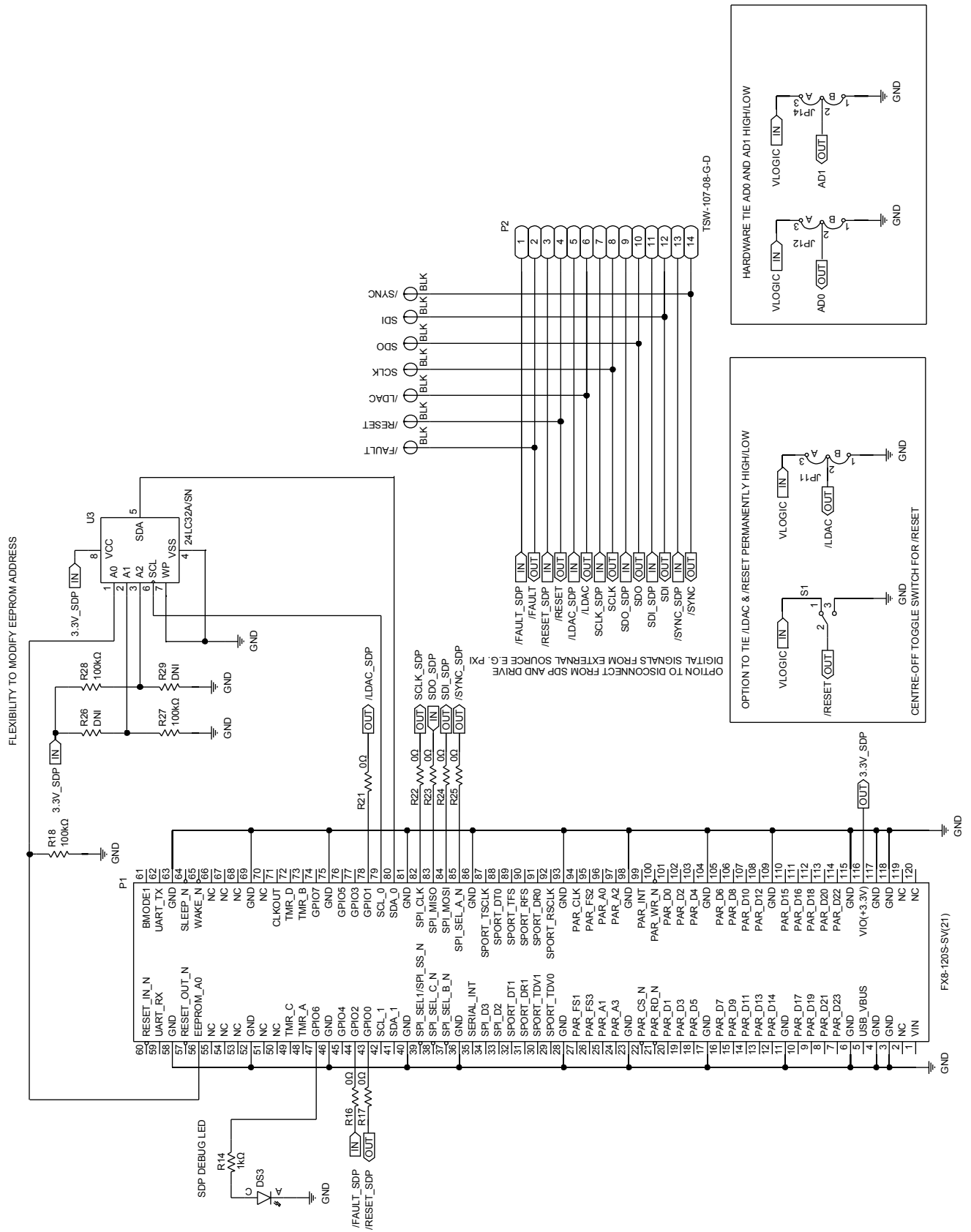

Figure 16. SDP-S Board Connections, Address Pins, LDAC and RESET Pins

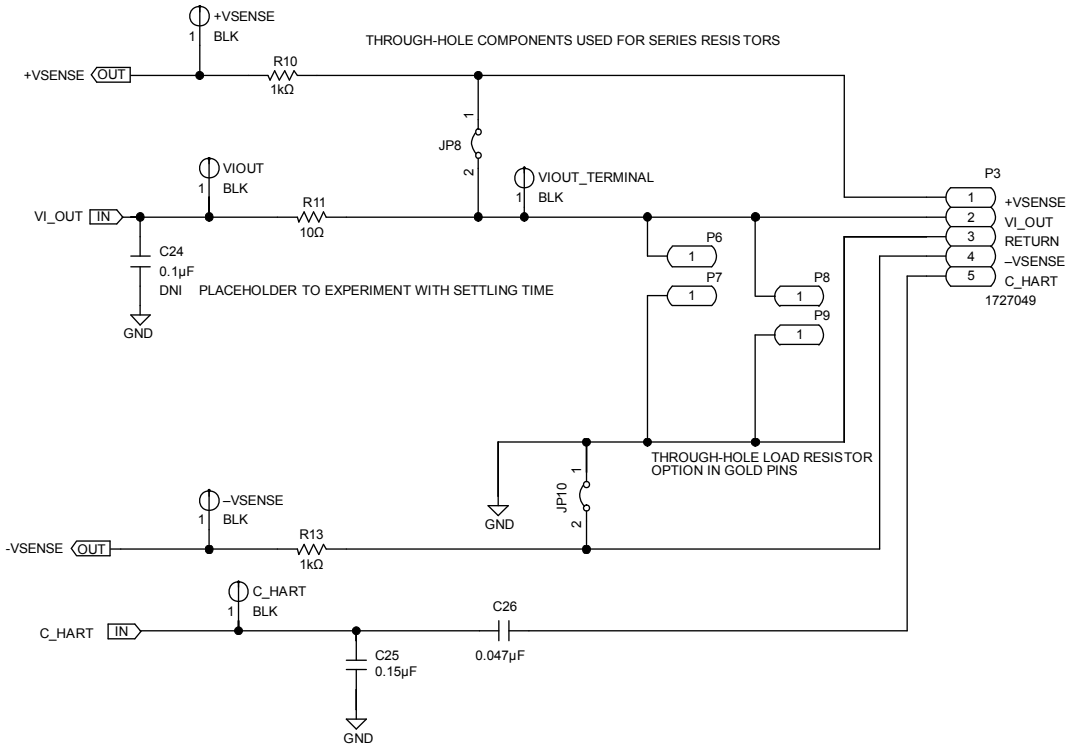

Figure 17. AD5413 Output Stage

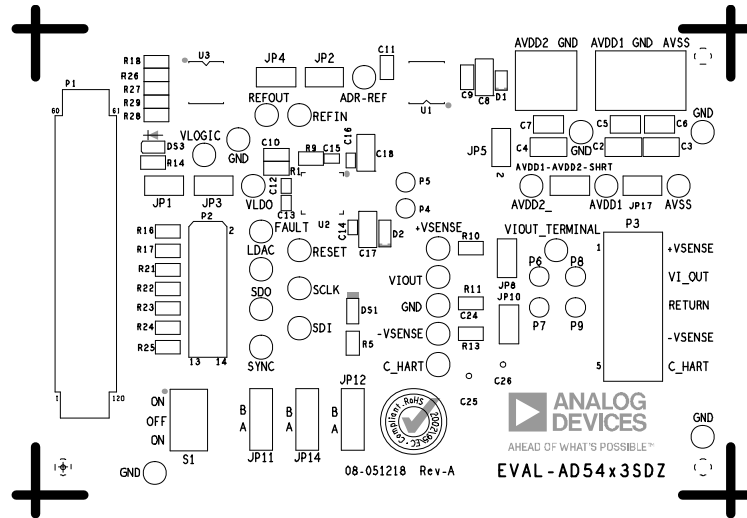

Figure 18. AD5413 Evaluation Board Silkscreen, Primary

23146-017

23146-018

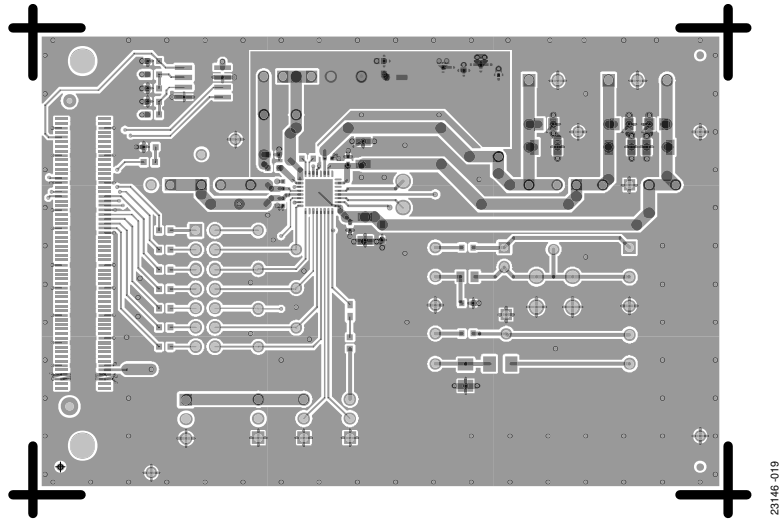

Figure 19. AD5413 Evaluation Board Layer 1, Primary

23146-019

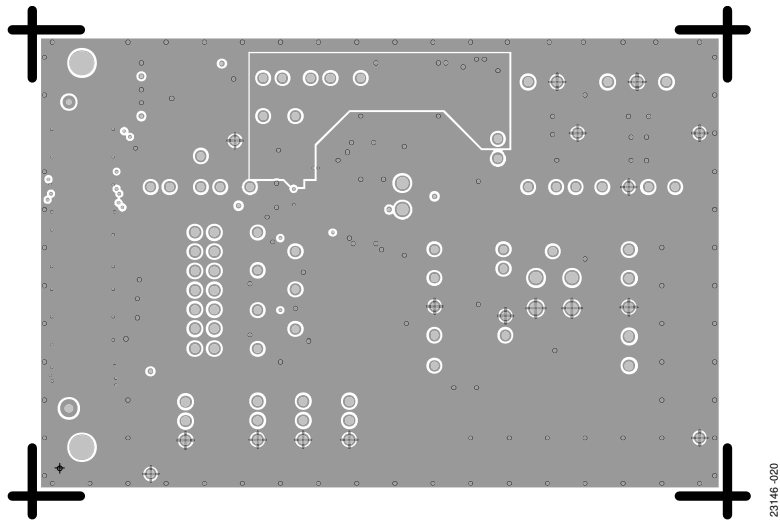

Figure 20. AD5413 Evaluation Board Layer 2 and Layer 3

23146-020

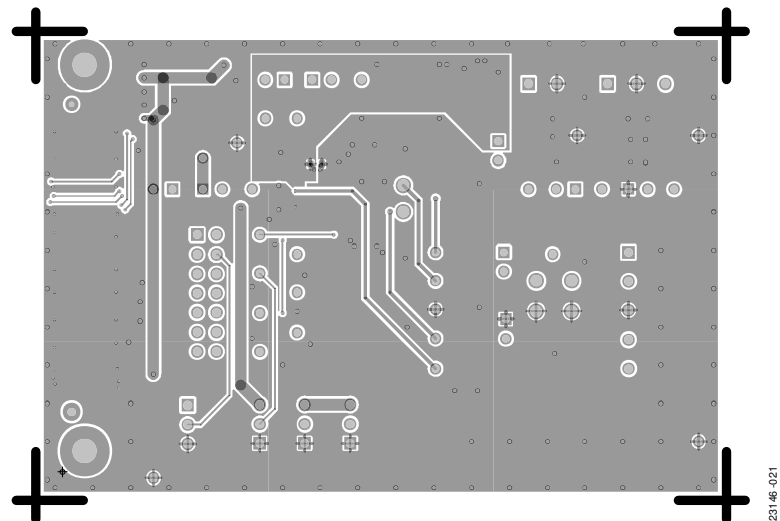

Figure 21. AD5413 Evaluation Board Layer 4, Secondary

23146-021

ORDERING INFORMATION

BILL OF MATERIALS

Table 5. Bill of Materials

Reference Designator	Description	Manufacturer	Part Number
+VSENSE, -VSENSE, ADR-REF, C_HART, FAULT, LDAC, REFIN, REFOUT, RESET, SCLK, SDI, SDO, SYNC, VIOUT, VIOUT_TERMINAL	Connectors, printed circuit board (PCB), test point black	Vero Technologies	20-2137
AVDD1, AVDD2, AVSS, VLDO, VLOGIC	Connectors, PCB, test point red	Keystone Electronics	5000
AVDD1-AVDD2-SHRT, JP1 to JP5, JP8, JP10, JP17	Connectors, PCB, jumper, male, 2-pin, 1X M000385	Amphenol FCI	69157-102
AVDD1 and AVSS	Connectors, PCB terminal block, 3-position	Phoenix Contact	1727023
AVDD2	Connector, PCB terminal block, 2-position, green	Phoenix Contact	1727010
C9, C11	Ceramic capacitors, 0603, X7R	KEMET	C0603C104K4RAC
C12 to C16	Ceramic capacitors, X7R	TDK	CGA2B3X7R1H104K050BB
C2 to C4, C17, C18	Ceramic capacitors, X7R, general-purpose	Murata	GRM31CR71H475KA12L
C25	Ceramic capacitor, X7R, 1206	AVX	12065C154KAT2A
C26	Ceramic capacitor, X7R, 1206	AVX	12065C473JAT2A
C5 to C7	Ceramic capacitors, X7R	AVX	08055C104JAT2A
C8	Ceramic capacitor, X7R, general-purpose	Yageo	CC1206KKX7R9BB105
C10	Ceramic capacitor, X7R	Murata	GCM188R70J225KE22D
C24	Ceramic capacitor, 0603, X7R	KEMET	C0603C104K4RAC
D1	Diode, Zener, voltage regulator	NXP Semiconductors	BZX585-C15
D2	Diode, Schottky, small signal	ST Microelectronics	BAT54KFILM
DS1	LED, surface mount diode (SMD), 0603, red	Vishay	TLMS1000-GS08
DS3	LED, SMD, 0603, green	Lumex	SML-LX0603GW-TR
GND1 to GND6	Connectors, PCB, test point, white	Keystone Electronics	5002
JP11, JP12, JP14	Connectors, PCB, 3-position male header, unshrouded, single-row, 2.54 mm pitch, 3 mm solder tail	Harwin	M20-9990345
P1	Connector, PCB, vertical type for SDP breakout board	HRS	FX8-120S-SV(21)
P2	Connector, PCB header, male, 14-position	Samtec	TSW-107-08-G-D
P3	Connector, PCB, terminal block, 5-position, green	Phoenix Contact	1727049
P4 to P9	Connectors, PCB, pin socket	Vero Technologies	66-3472
R1, R2, R16, R17, R21 to R25	Resistor films, SMD, 0603	Multicomp (SPC)	MC0603WG00000T5E-TC
R10, R13	Thick film, chip resistors	Multicomp (SPC)	MC0063W060311K
R11	Thick film, chip precision resistor	Panasonic	ERJ-6ENF10R0V
R5, R14	Thick film, chip resistors	Vishay	CRCW06031K00FKEAHP
R18, R27, R28	Thick film, chip resistors	Multicomp (SPC)	MC 0.063W 0603 1% 100K
R9	Thin film, chip resistor	TE Connectivity	RN73C1J13K7BTG
R26, R29	Thick film chip resistors	Multicomp (SPC)	MC 0.063W 0603 1% 100K
S1	Switch, tiny, washable toggle switch	Apem Components	TL39P0050
U1	Analog Devices, IC, ultralow noise, high accuracy voltage reference	Analog Devices	ADR4525BRZ
U2	Analog Devices, IC, single channel, 14-bit current or voltage output DAC with highway addressable remote transducer (HART) connectivity	Analog Devices	AD5413BCPZ-RL7
U3	IC, 32-kb serial EEPROM	Microchip Technology	24LC32A/SN

NOTES



ESD Caution

ESD (electrostatic discharge) sensitive device. Charged devices and circuit boards can discharge without detection. Although this product features patented or proprietary protection circuitry, damage may occur on devices subjected to high energy ESD. Therefore, proper ESD precautions should be taken to avoid performance degradation or loss of functionality.

Legal Terms and Conditions

By using the evaluation board discussed herein (together with any tools, components documentation or support materials, the "Evaluation Board"), you are agreeing to be bound by the terms and conditions set forth below ("Agreement") unless you have purchased the Evaluation Board, in which case the Analog Devices Standard Terms and Conditions of Sale shall govern. Do not use the Evaluation Board until you have read and agreed to the Agreement. Your use of the Evaluation Board shall signify your acceptance of the Agreement. This Agreement is made by and between you ("Customer") and Analog Devices, Inc. ("ADI"), with its principal place of business at One Technology Way, Norwood, MA 02062, USA. Subject to the terms and conditions of the Agreement, ADI hereby grants to Customer a free, limited, personal, temporary, non-exclusive, non-sublicensable, non-transferable license to use the Evaluation Board FOR EVALUATION PURPOSES ONLY. Customer understands and agrees that the Evaluation Board is provided for the sole and exclusive purpose referenced above, and agrees not to use the Evaluation Board for any other purpose. Furthermore, the license granted is expressly made subject to the following additional limitations: Customer shall not (i) rent, lease, display, sell, transfer, assign, sublicense, or distribute the Evaluation Board; and (ii) permit any Third Party to access the Evaluation Board. As used herein, the term "Third Party" includes any entity other than ADI, Customer, their employees, affiliates and in-house consultants. The Evaluation Board is NOT sold to Customer; all rights not expressly granted herein, including ownership of the Evaluation Board, are reserved by ADI. CONFIDENTIALITY. This Agreement and the Evaluation Board shall all be considered the confidential and proprietary information of ADI. Customer may not disclose or transfer any portion of the Evaluation Board to any other party for any reason. Upon discontinuation of use of the Evaluation Board or termination of this Agreement, Customer agrees to promptly return the Evaluation Board to ADI. ADDITIONAL RESTRICTIONS. Customer may not disassemble, decompile or reverse engineer chips on the Evaluation Board. Customer shall inform ADI of any occurred damages or any modifications or alterations it makes to the Evaluation Board, including but not limited to soldering or any other activity that affects the material content of the Evaluation Board. Modifications to the Evaluation Board must comply with applicable law, including but not limited to the RoHS Directive. TERMINATION. ADI may terminate this Agreement at any time upon giving written notice to Customer. Customer agrees to return to ADI the Evaluation Board at that time. LIMITATION OF LIABILITY. THE EVALUATION BOARD PROVIDED HEREUNDER IS PROVIDED "AS IS" AND ADI MAKES NO WARRANTIES OR REPRESENTATIONS OF ANY KIND WITH RESPECT TO IT. ADI SPECIFICALLY DISCLAIMS ANY REPRESENTATIONS, ENDORSEMENTS, GUARANTEES, OR WARRANTIES, EXPRESS OR IMPLIED, RELATED TO THE EVALUATION BOARD INCLUDING, BUT NOT LIMITED TO, THE IMPLIED WARRANTY OF MERCHANTABILITY, TITLE, FITNESS FOR A PARTICULAR PURPOSE OR NONINFRINGEMENT OF INTELLECTUAL PROPERTY RIGHTS. IN NO EVENT WILL ADI AND ITS LICENSORS BE LIABLE FOR ANY INCIDENTAL, SPECIAL, INDIRECT, OR CONSEQUENTIAL DAMAGES RESULTING FROM CUSTOMER'S POSSESSION OR USE OF THE EVALUATION BOARD, INCLUDING BUT NOT LIMITED TO LOST PROFITS, DELAY COSTS, LABOR COSTS OR LOSS OF GOODWILL. ADI'S TOTAL LIABILITY FROM ANY AND ALL CAUSES SHALL BE LIMITED TO THE AMOUNT OF ONE HUNDRED US DOLLARS (\$100.00). EXPORT. Customer agrees that it will not directly or indirectly export the Evaluation Board to another country, and that it will comply with all applicable United States federal laws and regulations relating to exports. GOVERNING LAW. This Agreement shall be governed by and construed in accordance with the substantive laws of the Commonwealth of Massachusetts (excluding conflict of law rules). Any legal action regarding this Agreement will be heard in the state or federal courts having jurisdiction in Suffolk County, Massachusetts, and Customer hereby submits to the personal jurisdiction and venue of such courts. The United Nations Convention on Contracts for the International Sale of Goods shall not apply to this Agreement and is expressly disclaimed.

©2020 Analog Devices, Inc. All rights reserved. Trademarks and registered trademarks are the property of their respective owners.
UG23146-5/20(0)



www.analog.com