

N-Channel Power MOSFET

500V, 4A, 2.7Ω

FEATURES

- 100% UIS and R_g tested
- Advanced planar process
- Compliant to RoHS Directive 2011/65/EU and in accordance to WEEE 2002/96/EC
- Halogen-free according to IEC 61249-2-21

KEY PERFORMANCE PARAMETERS

PARAMETER	VALUE	UNIT
V _{DS}	500	V
R _{DS(on)} (max)	2.7	Ω
Q _g	12	nC

APPLICATIONS

- AC/DC LED Lighting
- Power Supply
- Charger



TO-252 (DPAK)

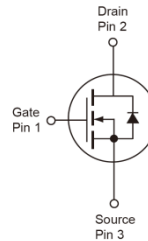
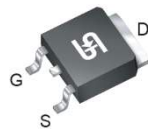

Notes: MSL 3 (Moisture Sensitivity Level) per J-STD-020

ABSOLUTE MAXIMUM RATINGS (T_A = 25°C unless otherwise noted)

PARAMETER	SYMBOL	Limit	UNIT
Drain-Source Voltage	V _{DS}	500	V
Gate-Source Voltage	V _{GS}	±20	V
Continuous Drain Current ^(Note 1)	I _D	T _C = 25°C	4
		T _C = 100°C	2.5
Pulsed Drain Current ^(Note 2)	I _{DM}	16	A
Total Power Dissipation @ T _C = 25°C	P _{DTOT}	83	W
Single Pulse Avalanche Energy ^(Note 3)	E _{AS}	78.4	mJ
Single Pulse Avalanche Current ^(Note 3)	I _{AS}	2.8	A
Operating Junction and Storage Temperature Range	T _J , T _{STG}	- 55 to +150	°C

THERMAL PERFORMANCE

PARAMETER	SYMBOL	Limit	UNIT
Junction to Case Thermal Resistance	R _{θJC}	1.5	°C/W
Junction to Ambient Thermal Resistance	R _{θJA}	62	°C/W

Thermal Performance Note: R_{θJA} is the sum of the junction-to-case and case-to-ambient thermal resistances. The case-thermal reference is defined at the solder mounting surface of the drain pins. R_{θJA} is guaranteed by design while R_{θCA} is determined by the user's board design. R_{θJA} shown below for single device operation on FR-4 PCB in still air.

ELECTRICAL SPECIFICATIONS ($T_A = 25^\circ\text{C}$ unless otherwise noted)						
PARAMETER	CONDITIONS	SYMBOL	MIN	TYP	MAX	UNIT
Static						
Drain-Source Breakdown Voltage	$V_{GS} = 0V, I_D = 250\mu A$	BV_{DSS}	500	--	--	V
Gate Threshold Voltage	$V_{DS} = V_{GS}, I_D = 250\mu A$	$V_{GS(TH)}$	2	2.2	3	V
Gate Body Leakage	$V_{GS} = \pm 20V, V_{DS} = 0V$	I_{GSS}	--	--	± 100	nA
Zero Gate Voltage Drain Current	$V_{DS} = 500V, V_{GS} = 0V$	I_{DSS}	--	--	1	μA
Drain-Source On-State Resistance (Note 4)	$V_{GS} = 10V, I_D = 1.7A$	$R_{DS(on)}$	--	2.4	2.7	Ω
Dynamic (Note 5)						
Total Gate Charge	$V_{DS} = 400V, I_D = 3.4A,$ $V_{GS} = 10V$	Q_g	--	12	--	nC
Gate-Source Charge		Q_{gs}	--	2.2	--	
Gate-Drain Charge		Q_{gd}	--	4.4	--	
Input Capacitance	$V_{DS} = 50V, V_{GS} = 0V,$ $f = 1.0MHz$	C_{iss}	--	453	--	pF
Output Capacitance		C_{oss}	--	27	--	
Reverse Transfer Capacitance		C_{rss}	--	1	--	
Gate Resistance	$f = 1.0MHz$	R_g	--	2.6	5.2	Ω
Switching (Note 6)						
Turn-On Delay Time	$V_{DD} = 250V, R_G = 5\Omega,$ $I_D = 3.4A, V_{GS} = 10V$	$t_{d(on)}$	--	5.4	--	ns
Turn-On Rise Time		t_r	--	18.4	--	
Turn-Off Delay Time		$t_{d(off)}$	--	12.4	--	
Turn-Off Fall Time		t_f	--	19.6	--	
Source-Drain Diode						
Forward Voltage (Note 4)	$I_S = 3.4A, V_{GS} = 0V$	V_{SD}	--	--	1.3	V
Reverse Recovery Time	$I_S = 3.4A$	t_{rr}	--	233	--	ns
Reverse Recovery Charge	$di_f/dt = 100A/\mu s$	Q_{rr}	--	0.84	--	μC

Notes:

1. Current limited by package
2. Pulse width limited by the maximum junction temperature
3. $L = 20mH, I_{AS} = 2.8A, V_{DD} = 50V, R_G = 25\Omega$, Starting $T_J = 25^\circ\text{C}$
4. Pulse test: $PW \leq 300\mu s$, duty cycle $\leq 2\%$
5. For DESIGN AID ONLY, not subject to production testing.
6. Switching time is essentially independent of operating temperature.

ORDERING INFORMATION

PART NO.	PACKAGE	PACKING
TSM4NC50CP ROG	TO-252 (DPAK)	2,500pcs / 13" Reel

CHARACTERISTICS CURVES

($T_A = 25^\circ\text{C}$ unless otherwise noted)

Output Characteristics

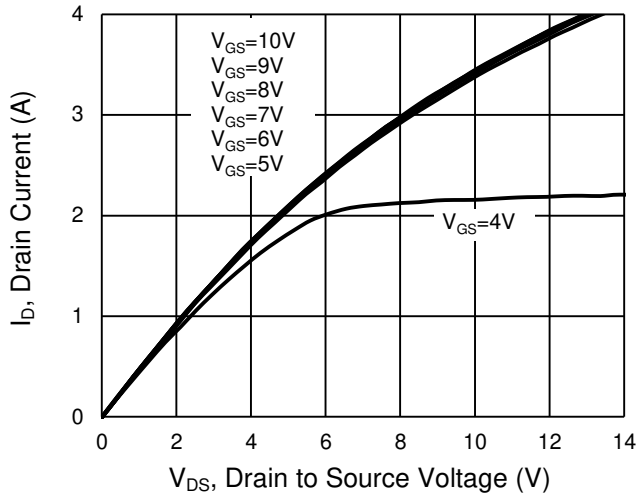

Transfer Characteristics

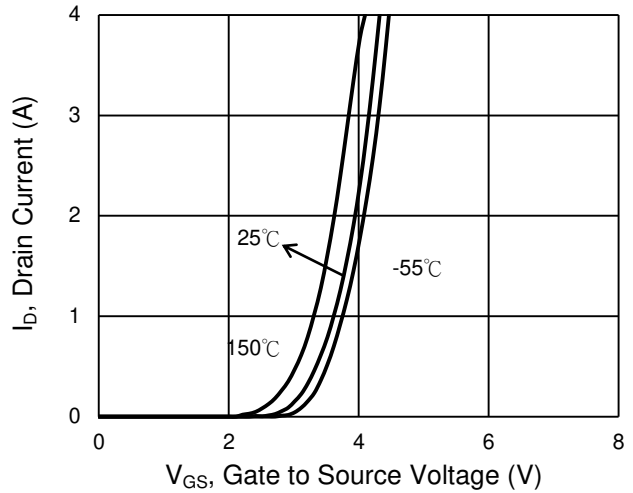

On-Resistance vs. Drain Current

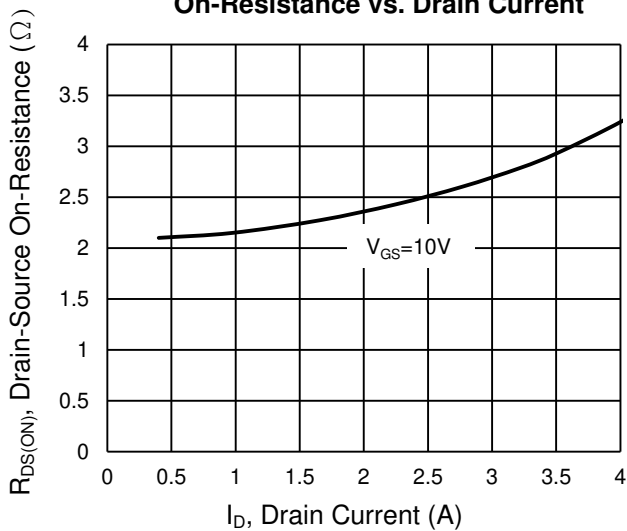

Gate-Source Voltage vs. Gate Charge

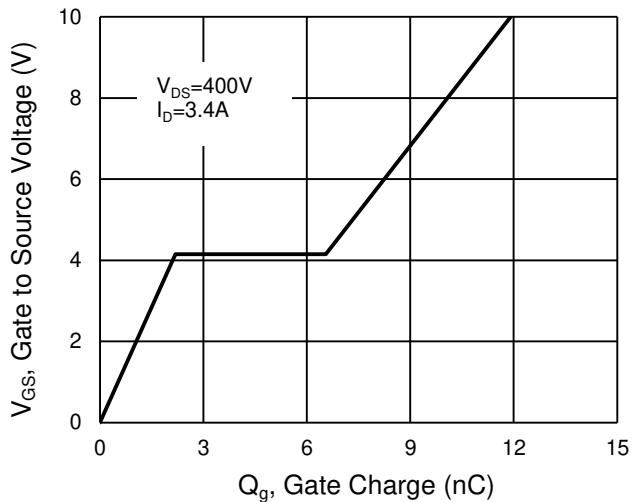

On-Resistance vs. Junction Temperature

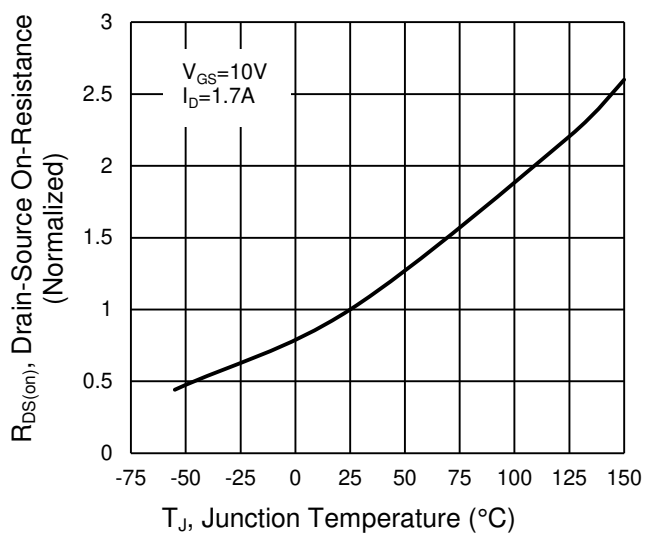

On-Resistance vs. Gate-Source Voltage

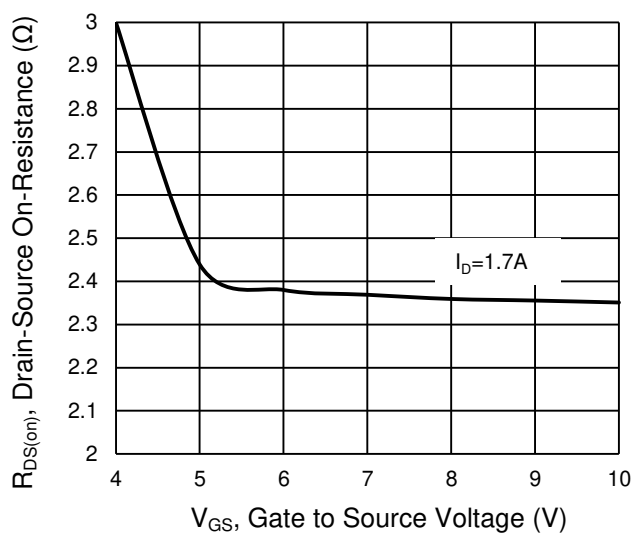

CHARACTERISTICS CURVES

($T_A = 25^\circ\text{C}$ unless otherwise noted)

Capacitance vs. Drain-Source Voltage

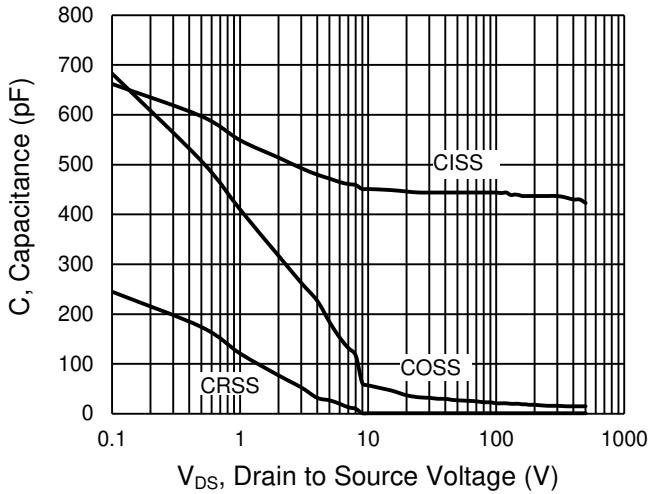

BV_{DSS} vs. Junction Temperature

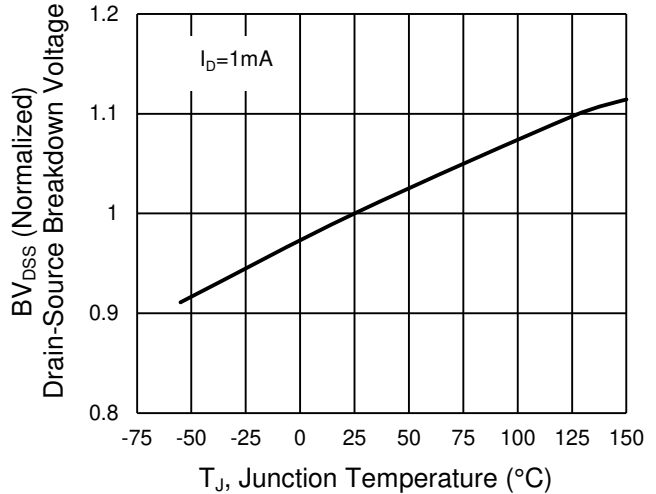

Maximum Safe Operating Area, Junction-to-Case

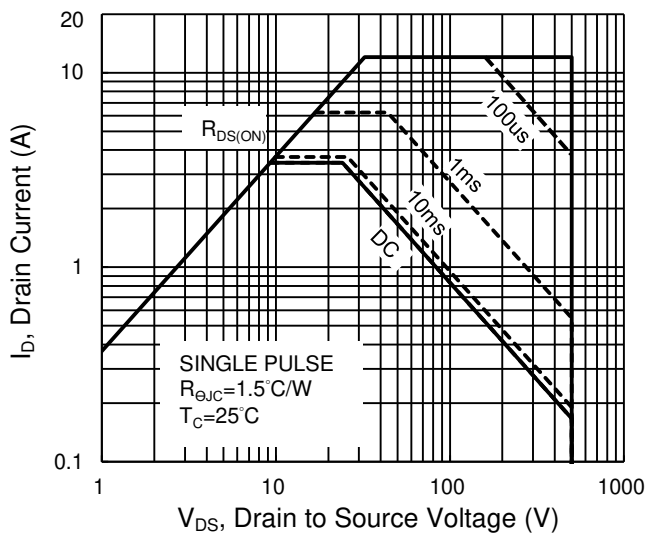

Source-Drain Diode Forward Current vs. Voltage

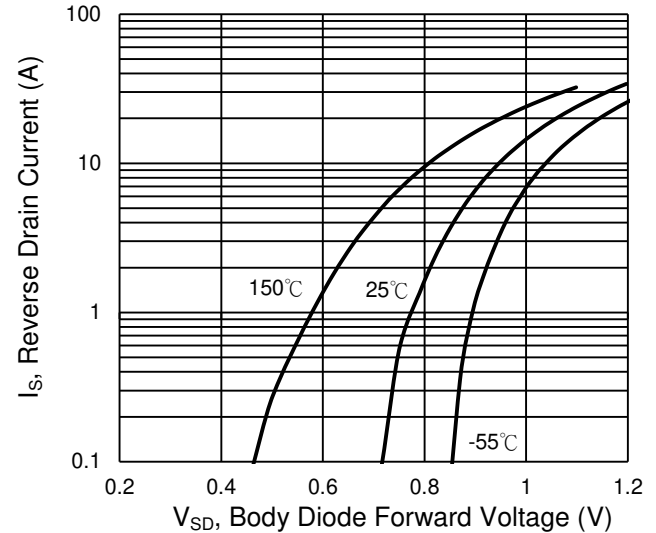

Normalized Thermal Transient Impedance, Junction-to-Case

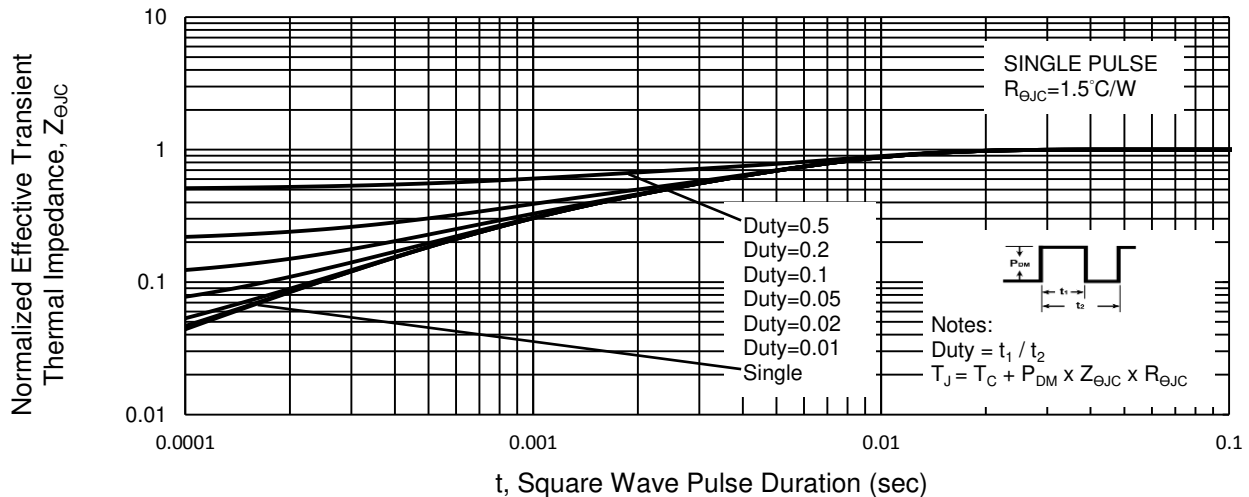

PACKAGE OUTLINE DIMENSIONS (Unit: Millimeters)

TO-252

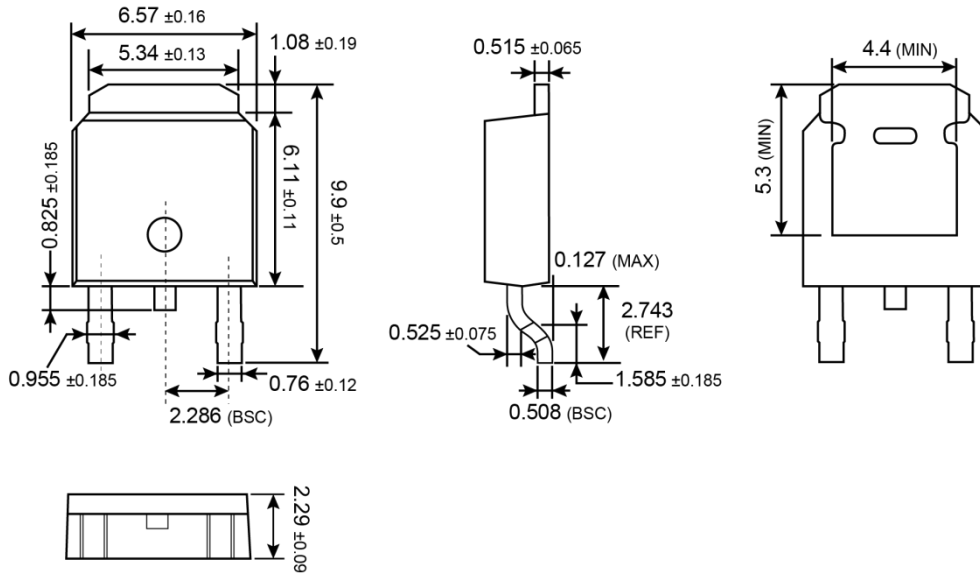

SUGGESTED PAD LAYOUT (Unit: Millimeters)

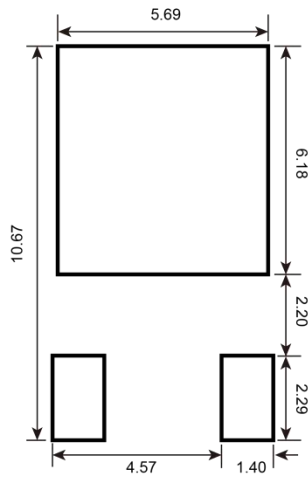

MARKING DIAGRAM

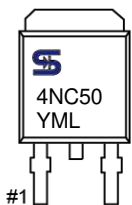

- Y** = Year Code
- M** = Month Code
- O** =Jan **P** =Feb **Q** =Mar **R** =Apr
- S** =May **T** =Jun **U** =Jul **V** =Aug
- W** =Sep **X** =Oct **Y** =Nov **Z** =Dec
- L** = Lot Code (1~9, A~Z)

Notice

Specifications of the products displayed herein are subject to change without notice. TSC or anyone on its behalf, assumes no responsibility or liability for any errors or inaccuracies.

Information contained herein is intended to provide a product description only. No license, express or implied, to any intellectual property rights is granted by this document. Except as provided in TSC's terms and conditions of sale for such products, TSC assumes no liability whatsoever, and disclaims any express or implied warranty, relating to sale and/or use of TSC products including liability or warranties relating to fitness for a particular purpose, merchantability, or infringement of any patent, copyright, or other intellectual property right.

The products shown herein are not designed for use in medical, life-saving, or life-sustaining applications. Customers using or selling these products for use in such applications do so at their own risk and agree to fully indemnify TSC for any damages resulting from such improper use or sale.