

2.4 GHz low pass filter matched to BLUENRG-LP-LPS (BLUENRG-3x5Vx, BLUENRG-3x5Ax, BLUENRG-332xx) in QFN and CSP packages

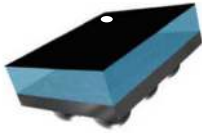

Chip scale package on glass 6 bumps

Pin-out top diagram (top view - bumps down)

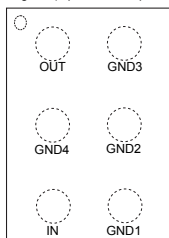

Features

- Integrated impedance matching to BLUENRG-LP-LPS (BLUENRG-3x5Vx, BLUENRG-3x5Ax, BLUENRG-332xx) in QFN and CSP packages
- 50 Ω nominal impedance on antenna side
- Deep rejection harmonics filter
- Low insertion loss
- Small footprint
- Low profile $\leq 630 \mu\text{m}$ after reflow
- High RF performances
- RF BOM and area reduction
- **ECOPACK2** compliant component

Applications

- Bluetooth 5
- OpenThread
- Zigbee[®]
- IEEE 802.15.4
- Optimized for BLUENRG-LP-LPS (BLUENRG-3x5Vx, BLUENRG-3x5Ax, BLUENRG-332xx) in QFN and CSP packages

Product status link

[MLPF-NRG-01D3](#)

Description

The **MLPF-NRG-01D3** integrates an impedance matching network and harmonics filter. The matching impedance network has been tailored to maximize the RF performances of BLUENRG-LP-LPS (BLUENRG-3x5Vx, BLUENRG-3x5Ax, BLUENRG-332xx) in QFN and CSP packages. This device uses STMicroelectronics IPD technology on non-conductive glass substrate which optimizes RF performances.

1 Characteristics

Table 1. Absolute ratings ($T_{amb} = 25\text{ °C}$)

Symbol	Parameter	Value	Unit
P_{IN}	Input power RF_{IN}	10	dBm
V_{ESD}	ESD ratings human body model (JESD22-A114-C), all I/O one at a time while others connected to GND	2000	V
T_{OP}	Maximum operating temperature	-40 to +105	°C

Table 2. Impedances ($T_{amb} = 25\text{ °C}$)

Symbol	Parameter	Value			Unit
		Min.	Typ.	Max.	
Z_{IN}	STM32WBxx single-ended impedance	-	Matched to BLUENRG-LP-LPS (BLUENRG-3x5Vx, BLUENRG-3x5Ax, BLUENRG-332xx) in QFN and CSP packages	-	Ω
Z_{OUT}	Antenna impedance	-	50	-	Ω

Table 3. Electrical characteristics and RF performances ($T_{amb} = 25\text{ °C}$)

Symbol	Parameter	Value			Unit
		Min.	Typ.	Max.	
f	Frequency range	2400		2500	MHz
IL	Insertion loss $ S_{21} $		0.9	1.1	dB
RL_{IN}	Input return loss $ S_{11} $	11	13		dB
RL_{OUT}	Output return loss $ S_{22} $	12	14		dB
Att	Harmonic rejection levels $ S_{21} $	Attenuation at 2fo (4800 – 5000) MHz	31	37	dB
		Attenuation at 3fo (7200 – 7500) MHz	42	43	dB
		Attenuation at 4fo (9600 – 10000) MHz	38	40	dB
		Attenuation at 5fo (12000 – 12500) MHz	32	34	dB

1.1 RF measurement

Figure 1. Transmission (dB)

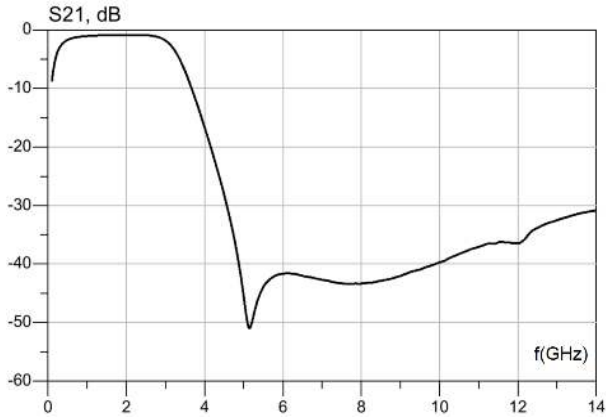

Figure 2. Insertion loss (dB)

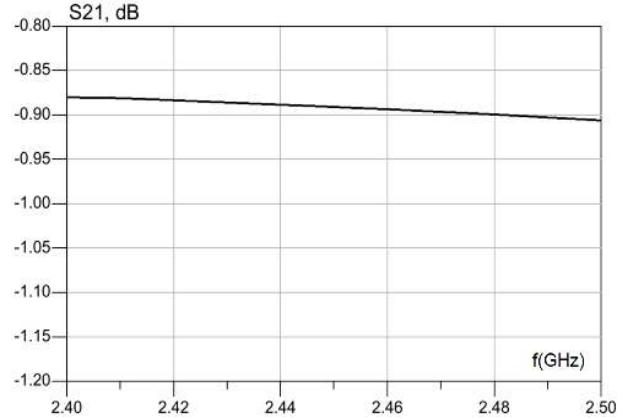

Figure 3. Input return loss (dB)

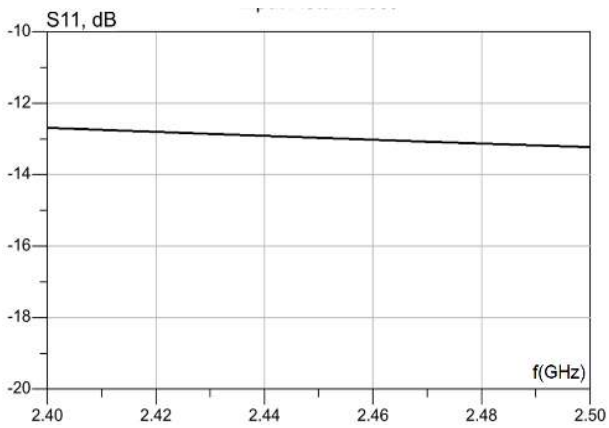

Figure 4. Output return loss (dB)

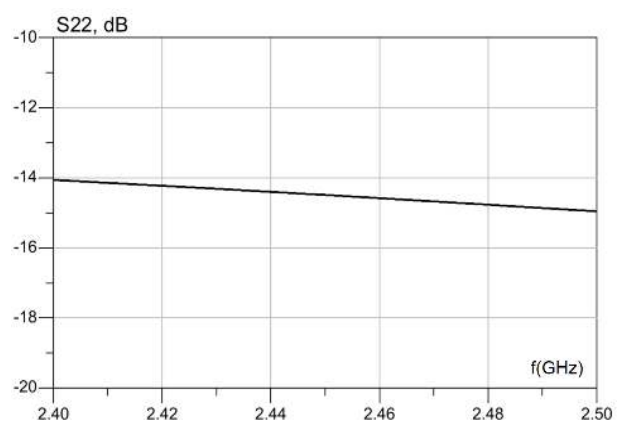

Figure 5. Attenuation 2f0 (dB)

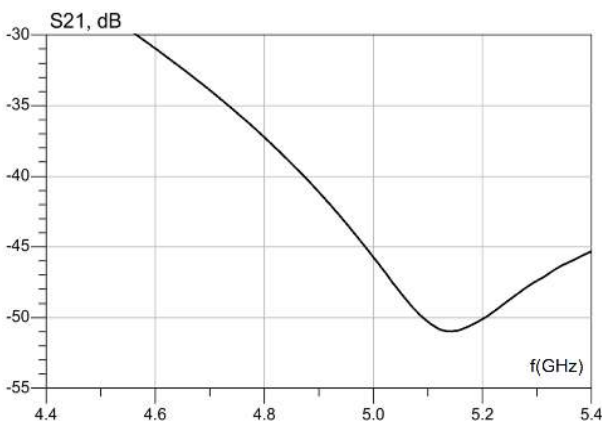

Figure 6. Attenuation 3f0 (dB)

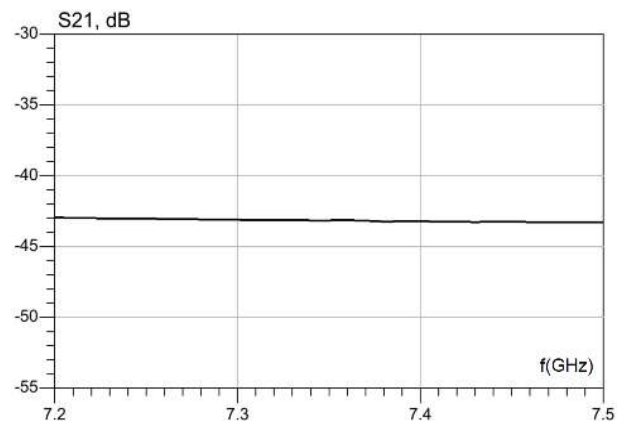

Figure 7. Attenuation 4f0 (dB)

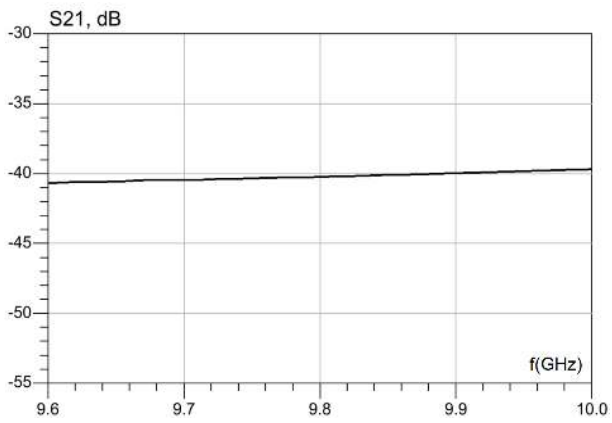
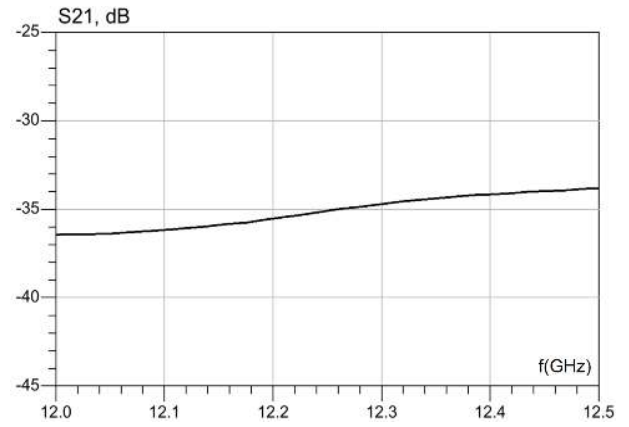

Figure 8. Attenuation 5f0 (dB)



2 Package information

In order to meet environmental requirements, ST offers these devices in different grades of **ECOPACK** packages, depending on their level of environmental compliance. ECOPACK specifications, grade definitions and product status are available at: www.st.com. ECOPACK is an ST trademark.

2.1 CSPG package information

Figure 9. CSPG package outline (bottom view - bumps up)

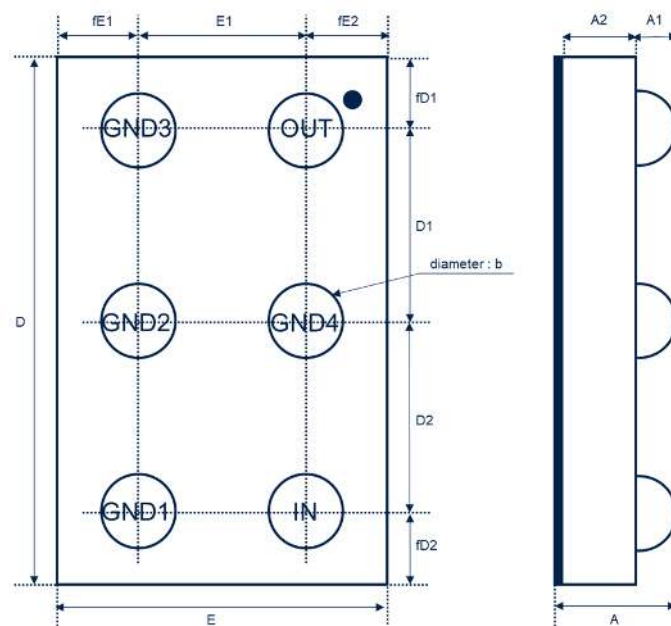

Table 4. CSPG 6 bumps mechanical data

Ref.	Dimensions		
	Millimeters		
	Min.	Typ.	Max.
A	0.580	0.630	0.680
A1	0.180	0.205	0.230
A2	0.380	0.400	0.420
b	0.230	0.255	0.280
D	1.550	1.600	1.650
D1		0.577	
D2		0.577	
E	0.950	1.000	1.050
E1		0.500	
fD1		0.223	
fD2		0.223	
fE1		0.250	
fE2		0.250	

Figure 10. Marking

Dot, ST logo
 ■ ECOPACK® Grade
 xx = marking
 z = manufacturing location
 yww = datecode
 (y = year
 ww = week)



Figure 11. Top view

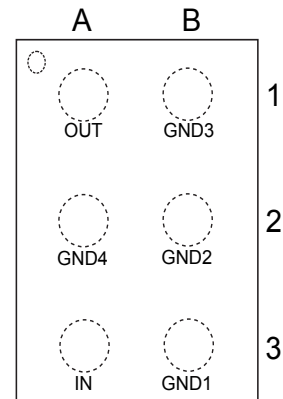

Table 5. Pad description top view (pads down)

Pad ref	Pad name	Description
A1	OUT	Antenna
A2	GND4	Ground
A3	IN	BLUENRG-LP-LPS (BLUENRG-3x5Vx, BLUENRG-3x5Ax, BLUENRG-332xx) in QFN and CSP packages
B1	GND3	Ground
B2	GND2	Ground
B3	GND1	Ground

Figure 12. Tape and reel outline

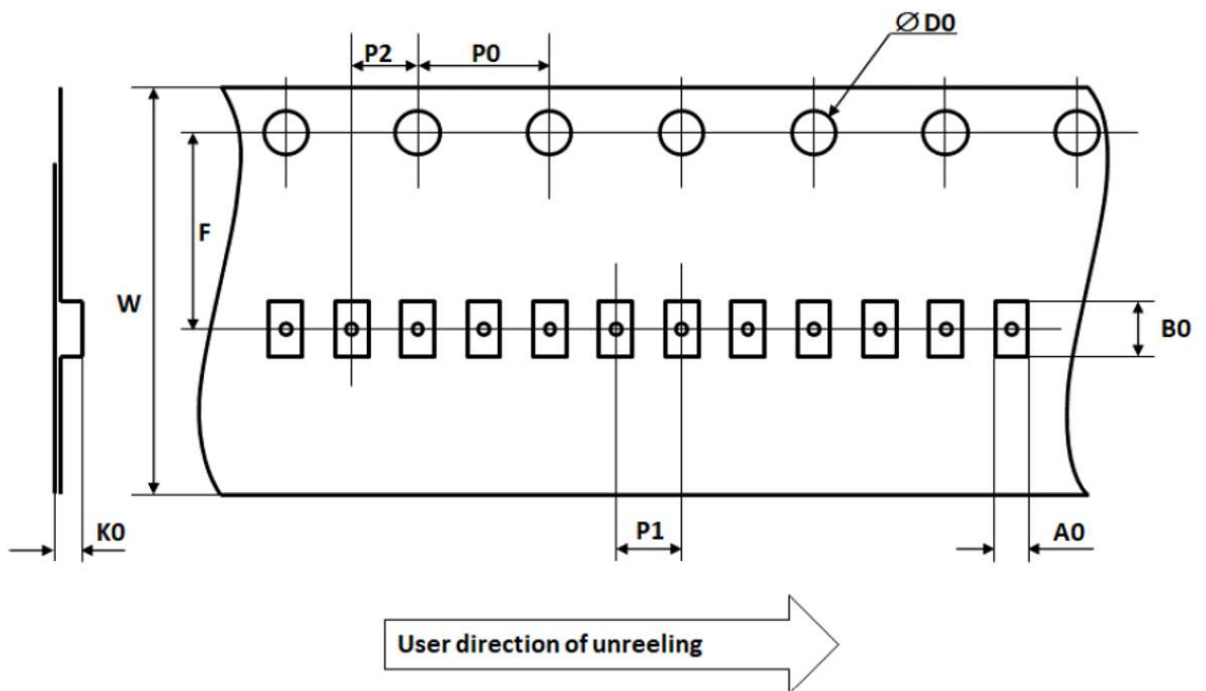

Table 6. Tape and reel mechanical data

Ref	Dimensions		
	Millimeters		
	Min	Typ	Max
A0	1.06	1.09	1.12
B0	1.66	1.69	1.72
D0	1.40	1.50	1.60
F	3.45	3.50	3.55
K0	0.69	0.72	0.75
P0	3.90	4.00	4.10
P1	1.95	2.00	2.05
P2	1.95	2.00	2.05
W	7.90	8.00	8.30

3 Recommendation on PCB assembly

3.1 Land pattern

Layout example using a QFN package for the BLUENRG-LP-LPS chipset.

Figure 13. PCB land pattern recommendations

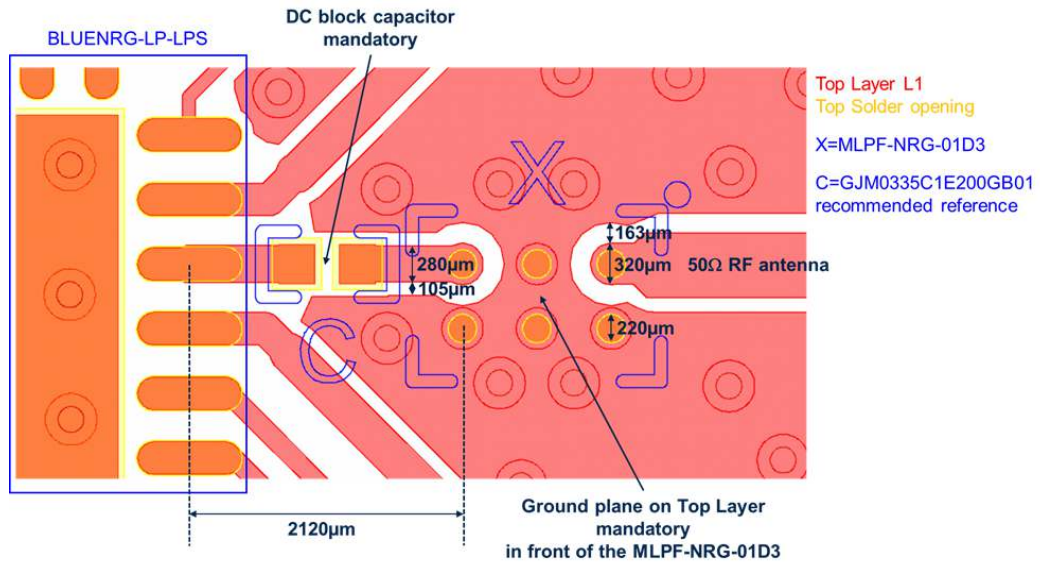

Transmission line between MLPF and antenna is dimensioned to 50 ohms characteristic impedance. Transmission line between STM32 and MLPF is dimensioned to 57 ohms characteristic impedance. These transmission line characteristics impedances have to be followed as close as possible. Moreover, lines physical dimensions will have to be tuned according to specific PCB stack up if different from the one presented in datasheet to keep expected characteristic impedance values.

Figure 14. PCB stack-up recommendations

#	Name	Material	Type	Thickness	Dk
	Top Overlay		Overlay		
	Top Solder	Solder Resist	Solder Mask	0.030mm	3.5
1	Top Layer	Copper	Signal	0.036mm	
	Dielectric 1	FR.4	Core	0.508mm	4.3
2	Bottom Layer	Copper	Signal	0.036mm	
	Bottom Solder	Solder Resist	Solder Mask	0.030mm	3.5
	Bottom Overlay		Overlay		

3.2 Stencil opening design

Figure 15. Footprint - 3 mils stencil -non solder mask defined

Copper pad diameter:
 220 μm recommended
 180 μm minimum
 260 μm maximum

Solder mask opening:
 320 μm recommended
 300 μm minimum
 340 μm maximum

Solder stencil opening:
 220 μm recommended

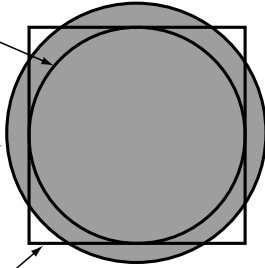
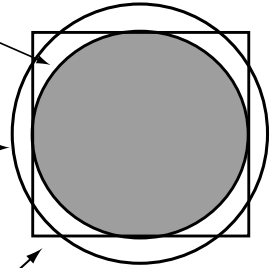

Figure 16. Footprint - 3 mils stencil - solder mask defined

Solder mask opening:
 220 μm recommended
 180 μm minimum
 260 μm maximum

Copper pad diameter:
 320 μm recommended
 300 μm minimum

Solder stencil opening:
 220 μm recommended



3.3 Solder paste

1. Halide-free flux qualification ROL0 according to ANSI/J-STD-004.
2. "No clean" solder paste is recommended.
3. Offers a high tack force to resist component movement during high speed.
4. Use solder paste with fine particles: powder particle size 20-38 μm .

3.4 Placement

1. Manual positioning is not recommended.
2. It is recommended to use the lead recognition capabilities of the placement system, not the outline centering
3. Standard tolerance of ± 0.05 mm is recommended.
4. 1.0 N placement force is recommended. Too much placement force can lead to squeezed out solder paste and cause solder joints to short. Too low placement force can lead to insufficient contact between package and solder paste that could cause open solder joints or badly centered packages.
5. To improve the package placement accuracy, a bottom side optical control should be performed with a high resolution tool.
6. For assembly, a perfect supporting of the PCB (all the more on flexible PCB) is recommended during solder paste printing, pick and place and reflow soldering by using optimized tools.

3.5 PCB design preference

1. To control the solder paste amount, the closed via is recommended instead of open vias.
2. The position of tracks and open vias in the solder area should be well balanced. A symmetrical layout is recommended, to avoid any tilt phenomena caused by asymmetrical solder paste due to solder flow away.

3.6 Reflow profile

Figure 17. ST ECOPACK recommended soldering reflow profile for PCB mounting

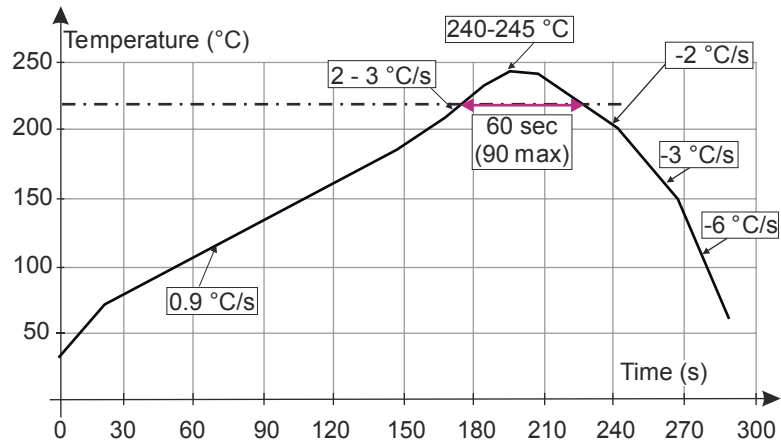

Note: Minimize air convection currents in the reflow oven to avoid component movement.

Note: More information is available in the application note:

- AN2348 Flip-Chip: "Package description and recommendations for use"

4 Ordering information

Table 7. Ordering information

Order code	Marking	Package	Weight	Base qty.	Delivery mode
MLPF-NRG-01D3	UB	CSPG	1.82 mg	5000	Tape and reel

Revision history

Table 8. Document revision history

Date	Revision	Changes
29-Jul-2022	1	Initial release.
09-Aug-2022	2	Updated Figure 13 and Figure 14 .
25-Nov-2022	3	Updated Section 3.1 Land pattern.

IMPORTANT NOTICE – READ CAREFULLY

STMicroelectronics NV and its subsidiaries (“ST”) reserve the right to make changes, corrections, enhancements, modifications, and improvements to ST products and/or to this document at any time without notice. Purchasers should obtain the latest relevant information on ST products before placing orders. ST products are sold pursuant to ST’s terms and conditions of sale in place at the time of order acknowledgment.

Purchasers are solely responsible for the choice, selection, and use of ST products and ST assumes no liability for application assistance or the design of purchasers’ products.

No license, express or implied, to any intellectual property right is granted by ST herein.

Resale of ST products with provisions different from the information set forth herein shall void any warranty granted by ST for such product.

ST and the ST logo are trademarks of ST. For additional information about ST trademarks, refer to www.st.com/trademarks. All other product or service names are the property of their respective owners.

Information in this document supersedes and replaces information previously supplied in any prior versions of this document.

© 2022 STMicroelectronics – All rights reserved