

OSRAM KB CSLNM1.14

Datasheet

Published by **ams-OSRAM AG**

Tobelbader Strasse 30, 8141 Premstaetten, Austria

Phone +43 3136 500-0

ams-osram.com

© All rights reserved



OSRAM OSTAR® Projection Compact

KB CSLNM1.14

Compact light source with isolated heat sink for improved heat dissipation and high current chip technology for increased light output.



Applications

- Projection Home LED & Laser
- Projection Professional LED & Laser
- Stage Lighting (LED & Laser)

Features

- Package: white molded SMD ceramic package
- Chip technology: UX:3
- Typ. Radiation: 120° (Lambertian emitter)
- Color: $\lambda_{\text{dom}} = 455 \text{ nm}$ (• blue)
- Corrosion Robustness Class: 3A
- ESD: 8 kV acc. to ANSI/ESDA/JEDEC JS-001 (HBM, Class 3B)

Ordering Information

Type	Total radiant flux ¹⁾ $I_F = 1000 \text{ mA}$ Φ_E	Ordering Code
KB CSLNM1.14-4V7A-46	1000 ... 1590 mW	Q65112A3602
KB CSLNM1.14-5A8A-23	1120 ... 1800 mW	Q65113A1588

Maximum Ratings

Parameter	Symbol		Values
Operating Temperature	T_{op}	min.	-40 °C
		max.	125 °C
Storage Temperature	T_{stg}	min.	-40 °C
		max.	125 °C
Junction Temperature	T_j	max.	150 °C
Forward current $T_s = 25\text{ °C}$	I_F	min.	40 mA
		max.	3000 mA
Forward current pulsed $D = 0.5; f = 240\text{Hz}; T_s = 25\text{°C}$	$I_{F\ pulse}$	max.	4000 mA
Surge current $t_p \leq 50\ \mu\text{s}; D = 0.1; T_s = 25\text{ °C}$	I_{FS}	max.	4500 mA
ESD withstand voltage acc. to ANSI/ESDA/JEDEC JS-001 (HBM, Class 3B)	V_{ESD}		8 kV
Reverse current ²⁾	I_R	max.	200 mA

Characteristics

$I_F = 1000 \text{ mA}$; $T_S = 25 \text{ °C}$

Parameter	Symbol		Values
Peak Wavelength	λ_{peak}	typ.	450 nm
Dominant Wavelength ³⁾ $I_F = 1000 \text{ mA}$	λ_{dom}	min. typ. max.	445 nm 455 nm 465 nm
Viewing angle at 50% I_V	2ϕ	typ.	120 °
Radiating surface	A_{color}	typ.	1 x 1 mm ²
Partial Flux acc. CIE 127:2007	$\Phi_{E/V, 120^\circ}$	typ.	0.76
Forward Voltage ⁴⁾ $I_F = 1000 \text{ mA}$	V_F	min. typ. max.	2.75 V 3.00 V 3.50 V
Reverse voltage (ESD device)	$V_{R\text{ESD}}$	min.	45 V
Reverse voltage ²⁾ $I_R = 20 \text{ mA}$	V_R	max.	1.2 V
Real thermal resistance junction/solderpoint ⁵⁾	$R_{\text{thJS real}}$	typ. max.	4.1 K / W 4.9 K / W
Electrical thermal resistance junction/solderpoint ⁵⁾ with efficiency $\eta_e = 33 \%$	$R_{\text{thJS elec.}}$	typ. max.	2.7 K / W 3.3 K / W

Brightness Groups

Group	Total radiant flux ¹⁾ $I_F = 1000 \text{ mA}$ min. Φ_E	Total radiant flux ¹⁾ $I_F = 1000 \text{ mA}$ max. Φ_E
4V	1000 mW	1120 mW
5A	1120 mW	1250 mW
6A	1250 mW	1400 mW
7A	1400 mW	1590 mW
8A	1590 mW	1800 mW

Wavelength Groups

Group	Dominant Wavelength ³⁾ $I_F = 1000 \text{ mA}$ min. λ_{dom}	Dominant Wavelength ³⁾ $I_F = 1000 \text{ mA}$ max. λ_{dom}
2	445 nm	449 nm
3	449 nm	453 nm
4	453 nm	457 nm
5	457 nm	461 nm
6	461 nm	465 nm

Group Name on Label

Example: 4V-2

Brightness	Wavelength
4V	2

Relative Spectral Emission ⁶⁾

$E_{rel} = f(\lambda); I_F = 1000 \text{ mA}; T_J = 25 \text{ }^\circ\text{C}$

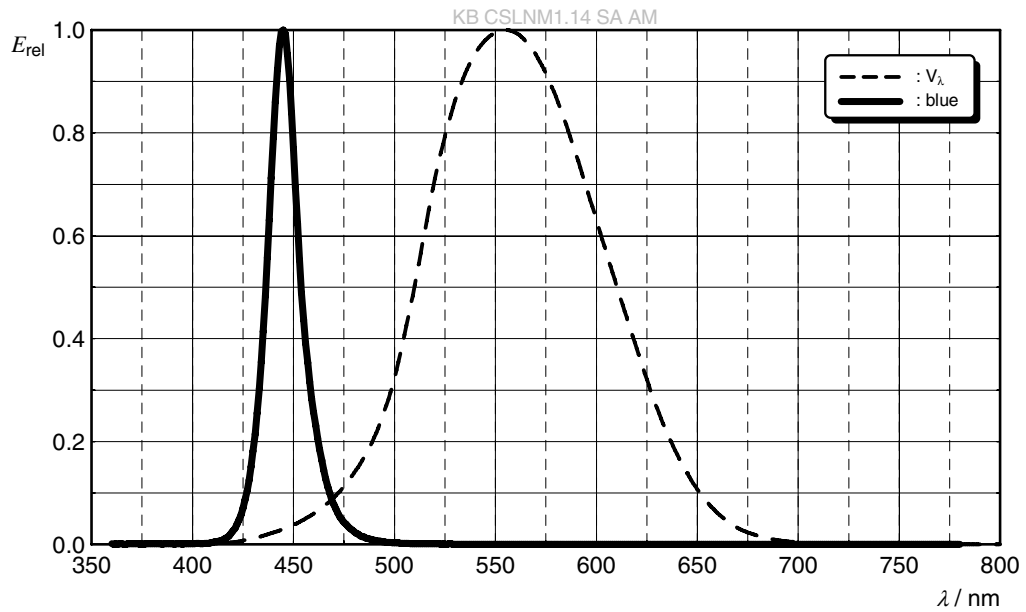

Radiation Characteristics ⁶⁾

$I_{rel} = f(\phi); T_J = 25 \text{ }^\circ\text{C}$

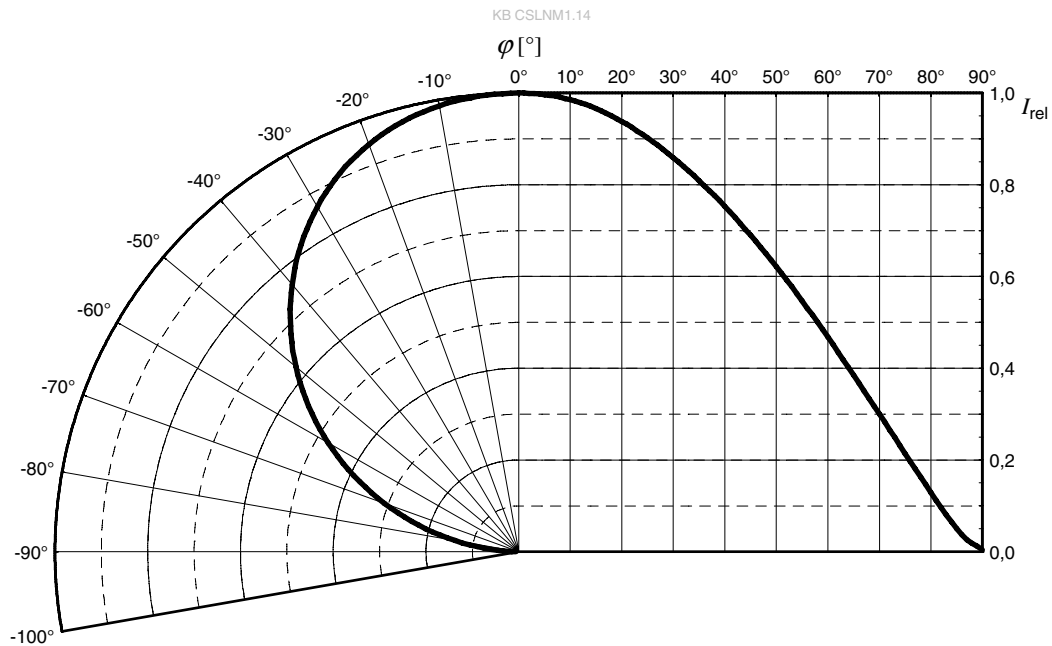

Relative Partial Flux ⁶⁾

$\Phi_E(2\varphi)/\Phi_E(180^\circ) = f(\varphi); T_j = 25\text{ }^\circ\text{C}$

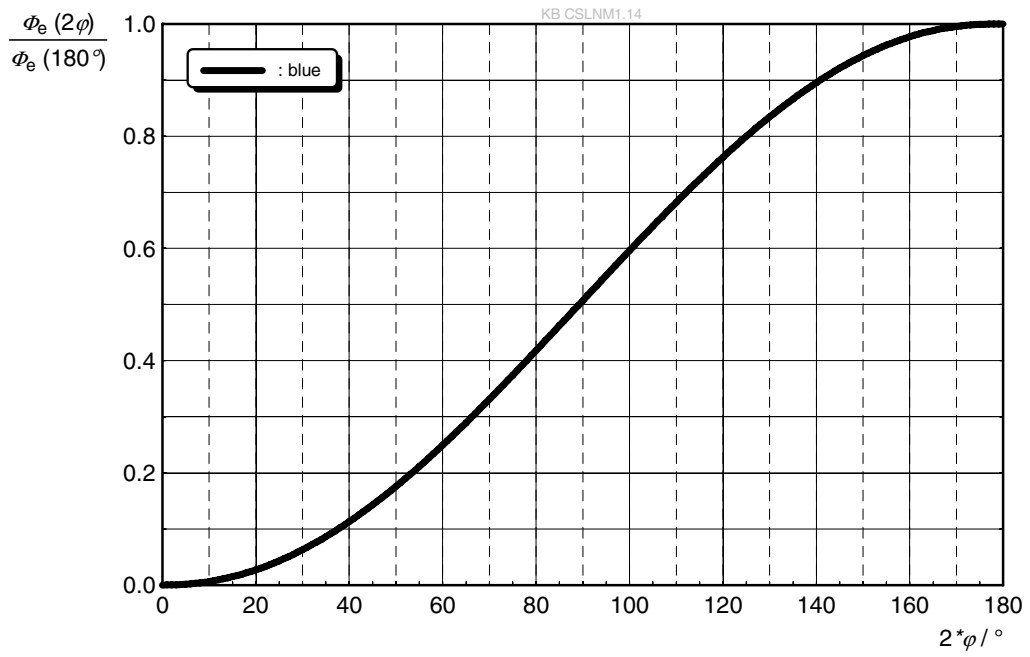

Forward current ^{6), 7)}

$$I_F = f(V_F); T_J = 25\text{ °C}$$

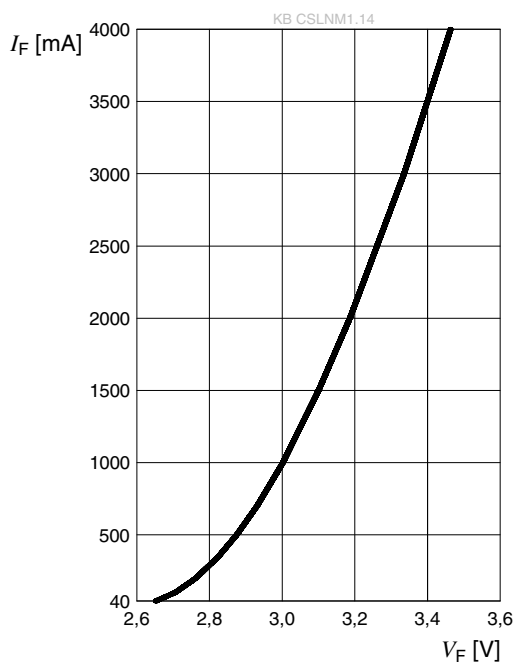

Relative Radiant Power ^{6), 7)}

$$\Phi_E / \Phi_E(1000\text{ mA}) = f(I_F); T_J = 25\text{ °C}$$

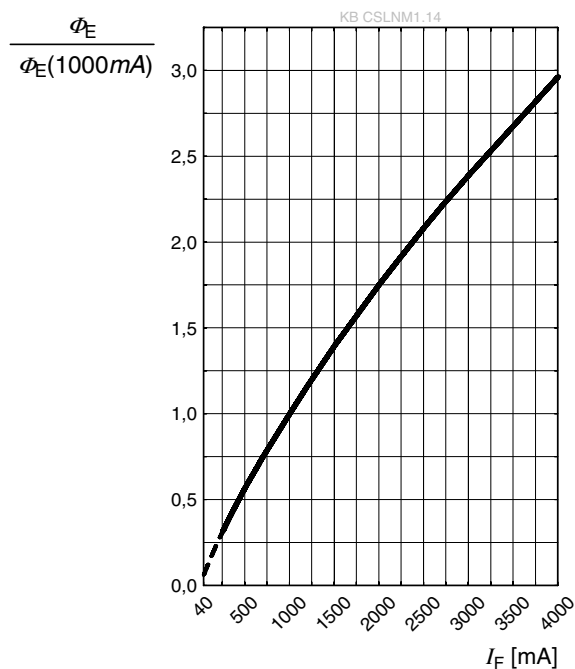

Dominant Wavelength ⁶⁾

$$\Delta\lambda_{\text{dom}} = f(I_F); T_J = 25\text{ °C}$$

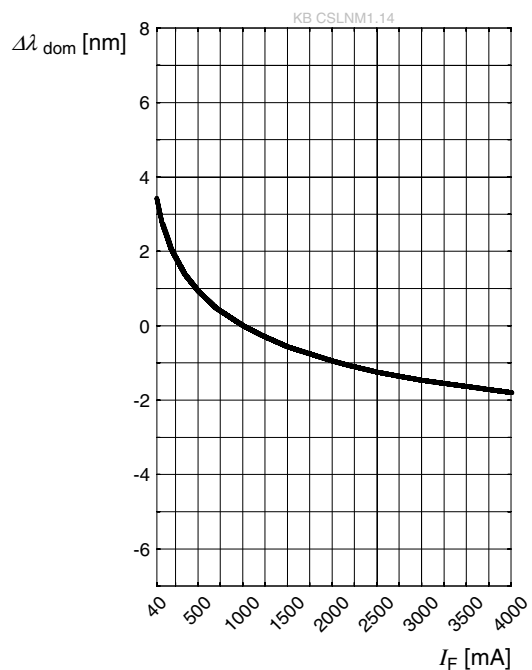

Forward Voltage ⁶⁾

$$\Delta V_F = V_F - V_F(25\text{ °C}) = f(T_j); I_F = 1000\text{ mA}$$

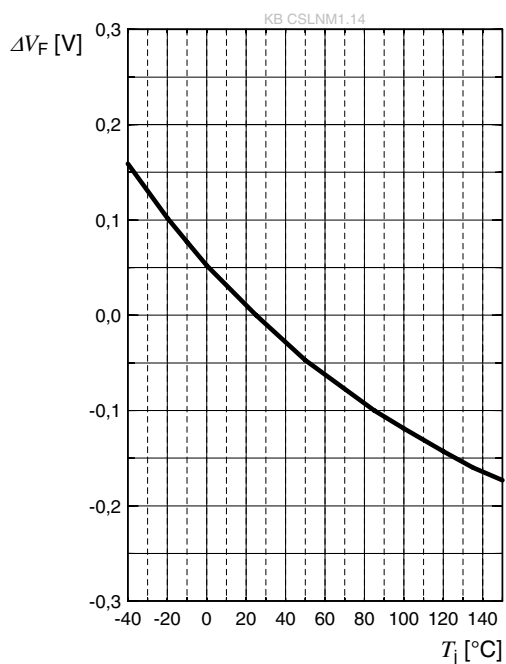

Relative Radiant Power ⁶⁾

$$\Phi_E / \Phi_E(25\text{ °C}) = f(T_j); I_F = 1000\text{ mA}$$

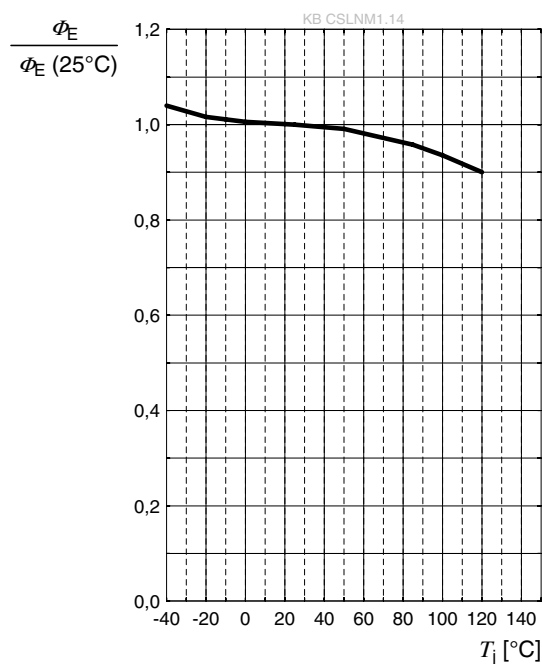

Dominant Wavelength ⁶⁾

$$\Delta \lambda_{\text{dom}} = \lambda_{\text{dom}} - \lambda_{\text{dom}}(25\text{ °C}) = f(T_j); I_F = 1000\text{ mA}$$

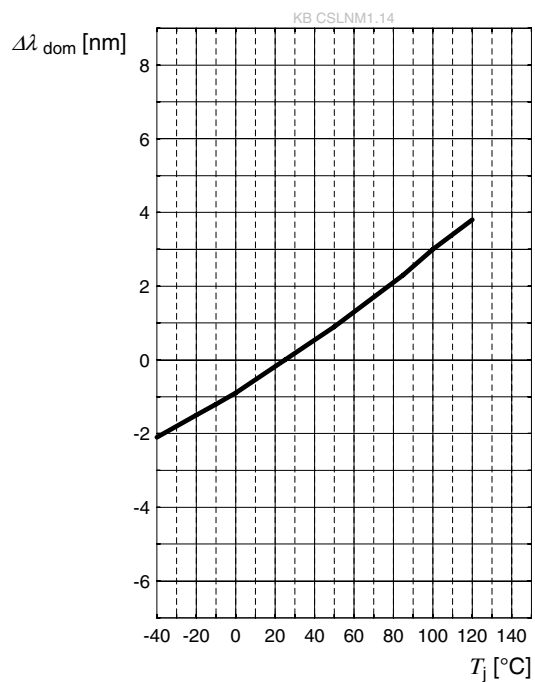

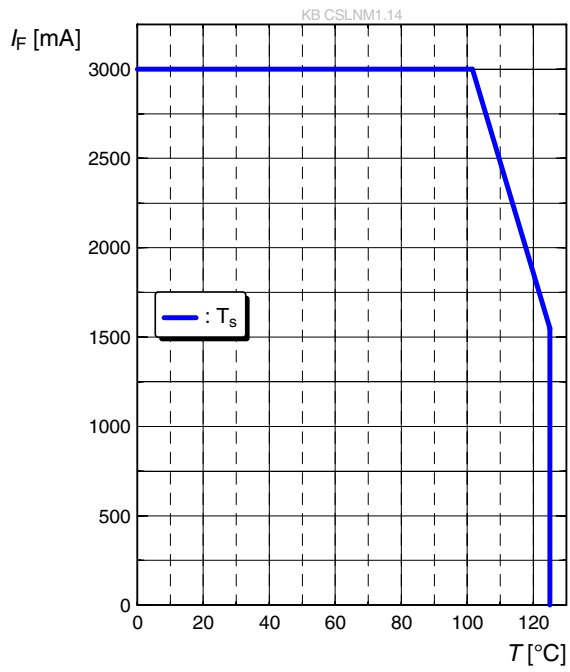

Max. Permissible Forward Current

$$I_F = f(T)$$

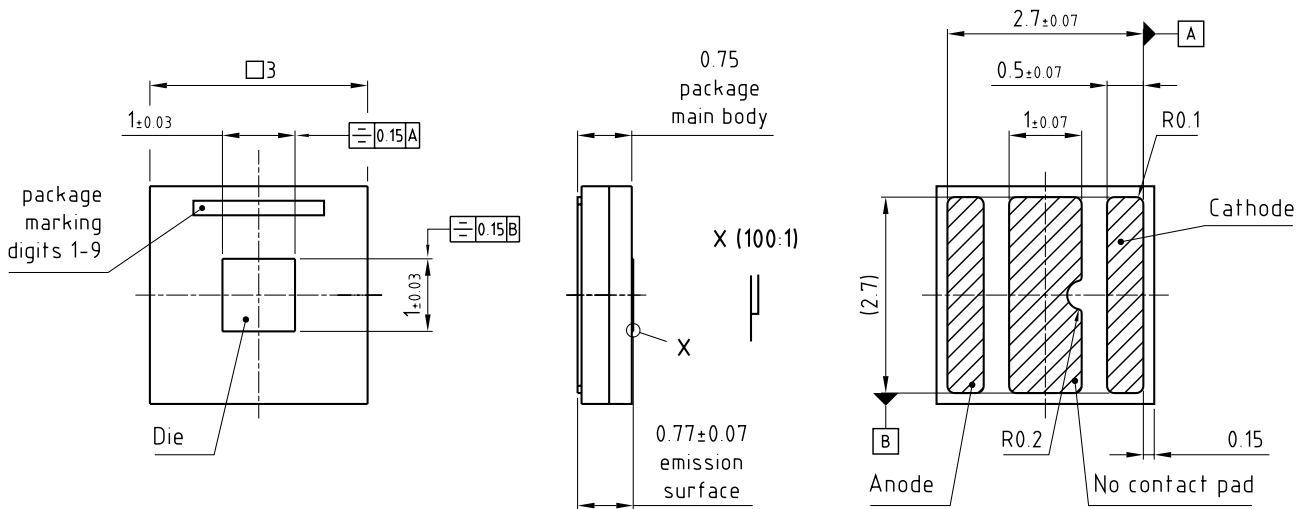

Dimensional Drawing ⁸⁾



general tolerance ± 0.1
lead finish Au 

C63062-A4 312-A3 -04

Further Information:

Approximate Weight: 36.0 mg

Package marking: Cathode

Corrosion test: Class: 3A
Test condition: 40°C / 90 % RH / 15 ppm H_2S / 14 days (stricter than IEC 60068-2-43)

ESD advice: The device is protected by ESD device which is connected in parallel to the Chip.

Electrical Internal Circuit

ESD Protection

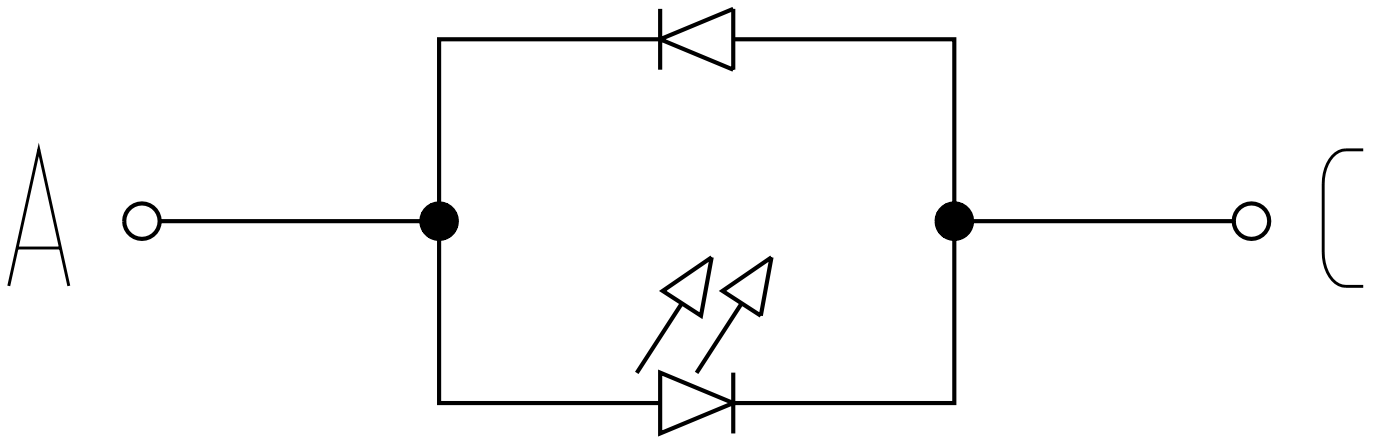

Recommended Solder Pad 8)

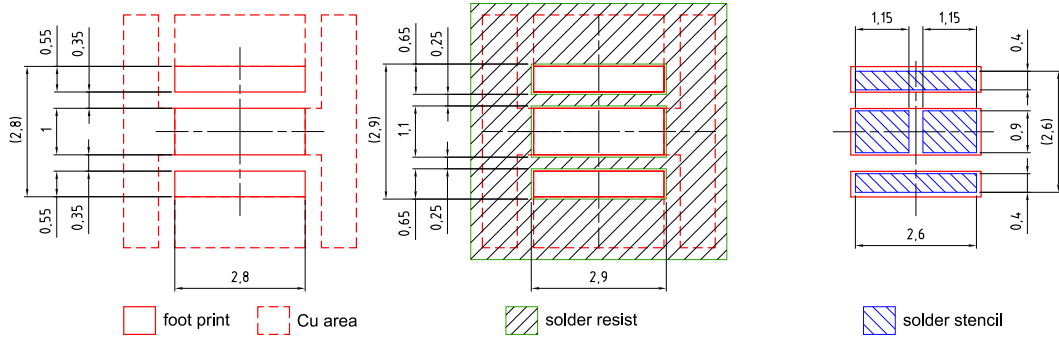

Component Location on Pad

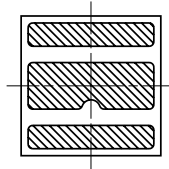
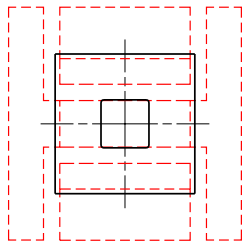

board material selection has high impact on system reliability

E062.3010.208 -02

Recommended Solder Pad 8)

Alternative Solder pad design for pedestal MCPB

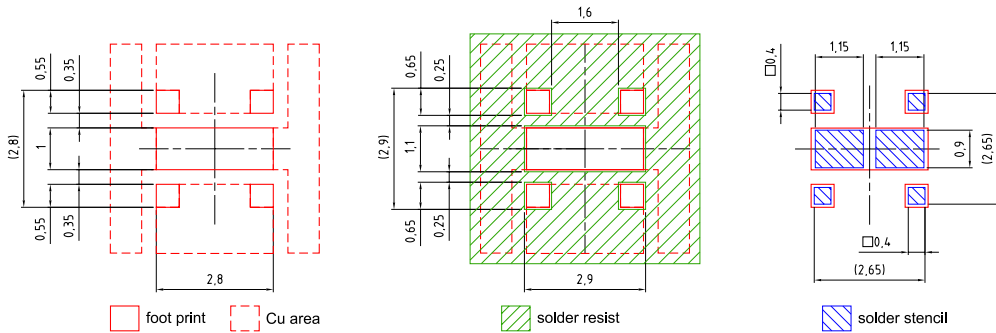

Component Location on Pad

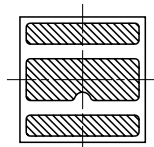
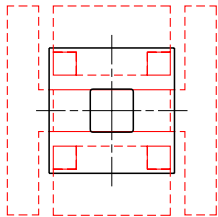

board material selection has high impact on system reliability

E062.3010.237-01

For superior solder joint connectivity results we recommend soldering under standard nitrogen atmosphere. Package not suitable for any kind of wet cleaning or ultrasonic cleaning.

Reflow Soldering Profile

Product complies to MSL Level 2 acc. to JEDEC J-STD-020E

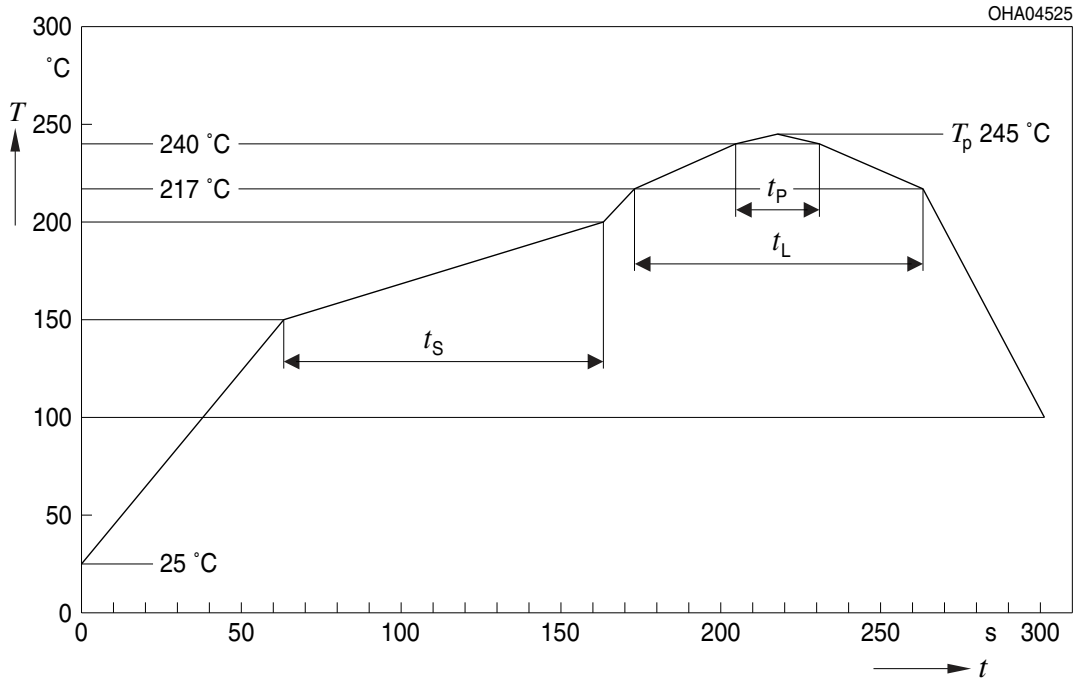

Profile Feature	Symbol	Pb-Free (SnAgCu) Assembly			Unit
		Minimum	Recommendation	Maximum	
Ramp-up rate to preheat ^{*)} 25 °C to 150 °C			2	3	K/s
Time t_s T_{Smin} to T_{Smax}	t_s	60	100	120	s
Ramp-up rate to peak ^{*)} T_{Smax} to T_p			2	3	K/s
Liquidus temperature	T_L		217		°C
Time above liquidus temperature	t_L		80	100	s
Peak temperature	T_p		245	260	°C
Time within 5 °C of the specified peak temperature $T_p - 5$ K	t_p	10	20	30	s
Ramp-down rate* T_p to 100 °C			3	6	K/s
Time 25 °C to T_p				480	s

All temperatures refer to the center of the package, measured on the top of the component

* slope calculation DT/Dt : Dt max. 5 s; fulfillment for the whole T-range

Taping ⁸⁾

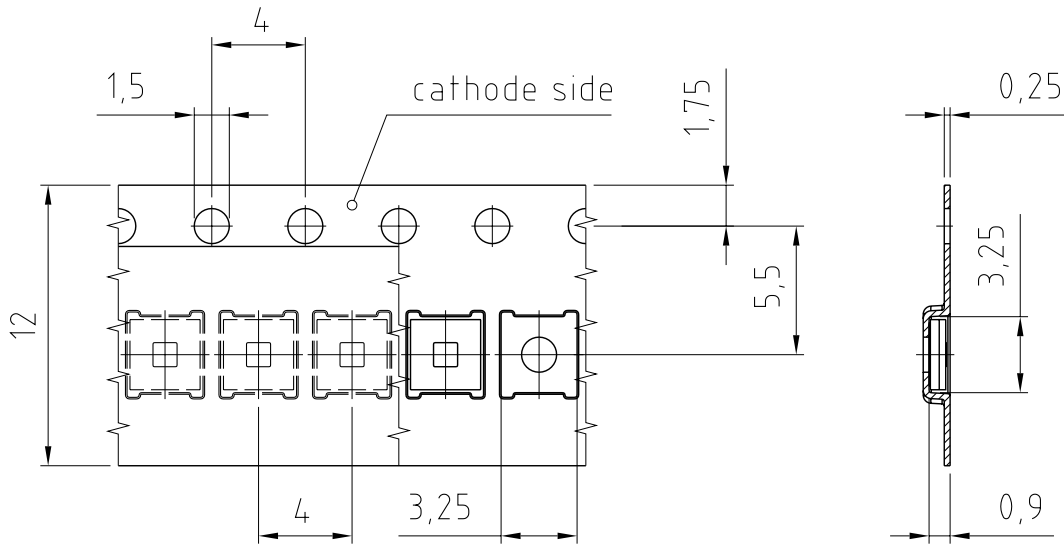

C63062-A4312-B3-03

Tape and Reel ⁹⁾

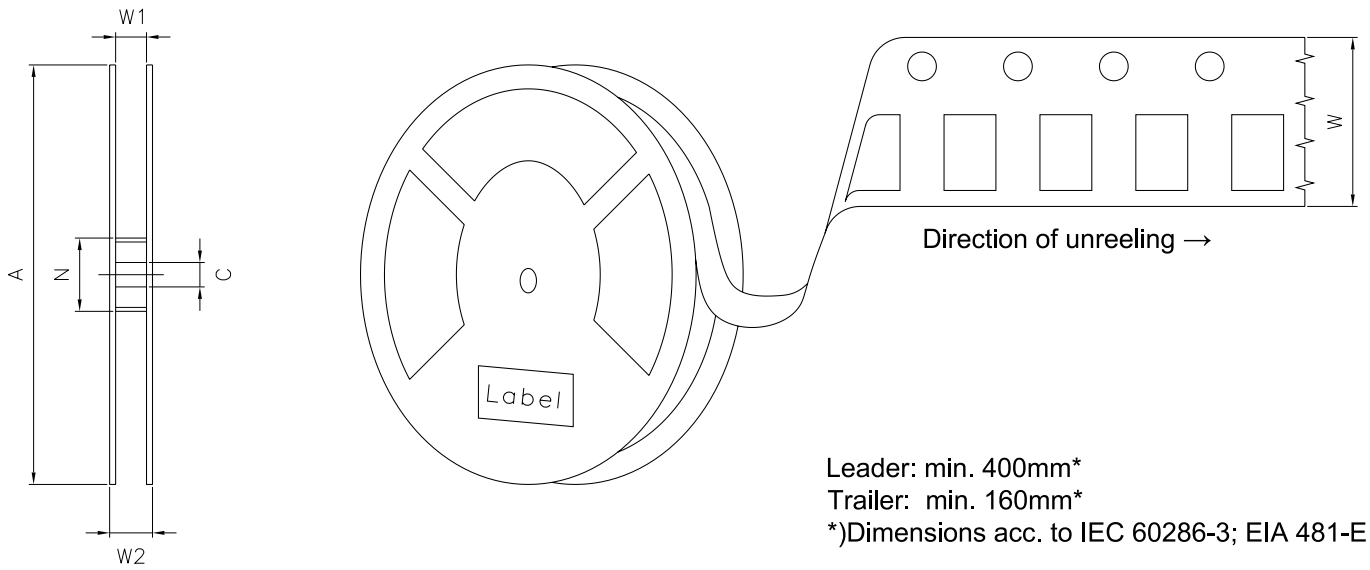

Reel Dimensions

A	W	N _{min}	W ₁	W _{2max}	Pieces per PU
180 mm	12 + 0.3 / - 0.1 mm	60 mm	12.4 + 2 mm	18.4 mm	1000

Barcode-Product-Label (BPL)

OSRAM Opto Semiconductors LX XXXX BIN1: XX-XX-X-XXX-X





RoHS Compliant

(6P) BATCH NO: 1234567890 ML Temp ST
X XXX °C X

(1T) LOT NO: 1234567890 (9D) D/C: 1234

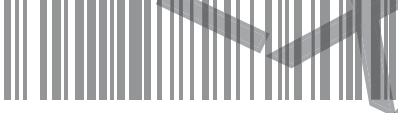
Pack: RXX
DEMY XXX
X_X123_1234.1234 X

(X) PROD NO: 123456789(Q)QTY: 9999 (G) GROUP: XX-XX-X-X

OHA04563

Dry Packing Process and Materials ⁸⁾

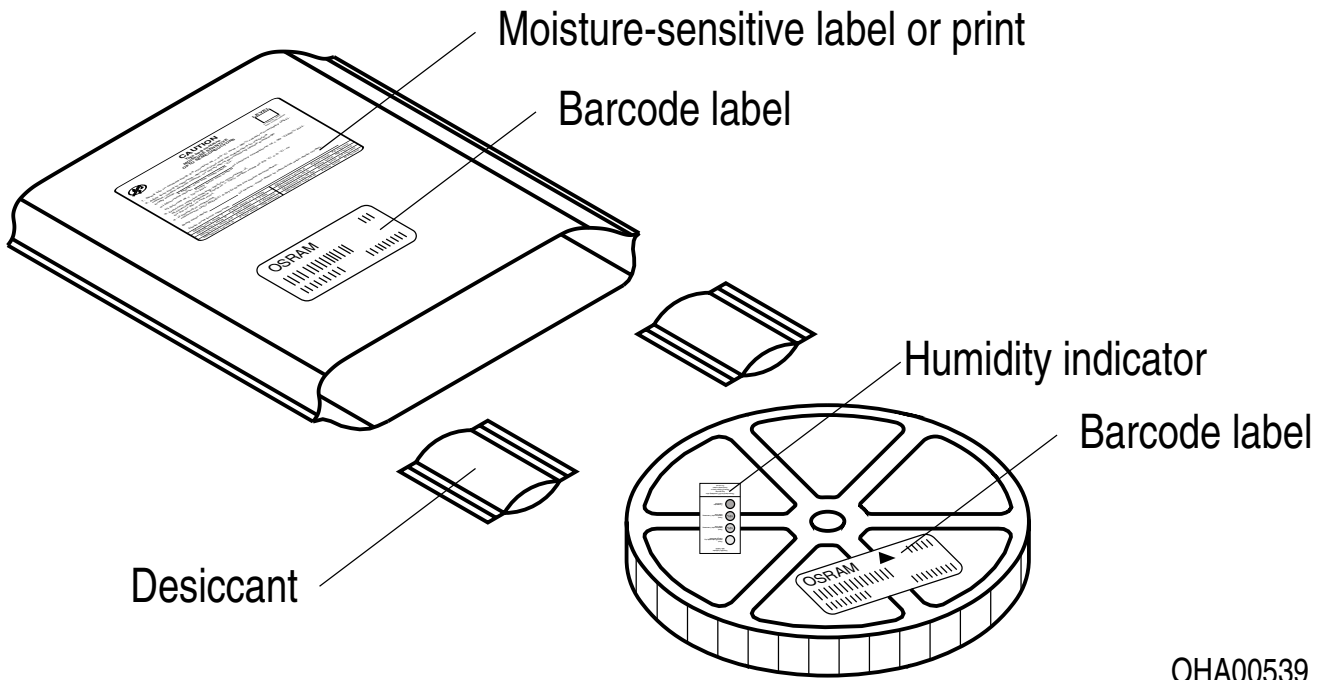

OHA00539

Moisture-sensitive product is packed in a dry bag containing desiccant and a humidity card according JEDEC-STD-033.

Type Designation System

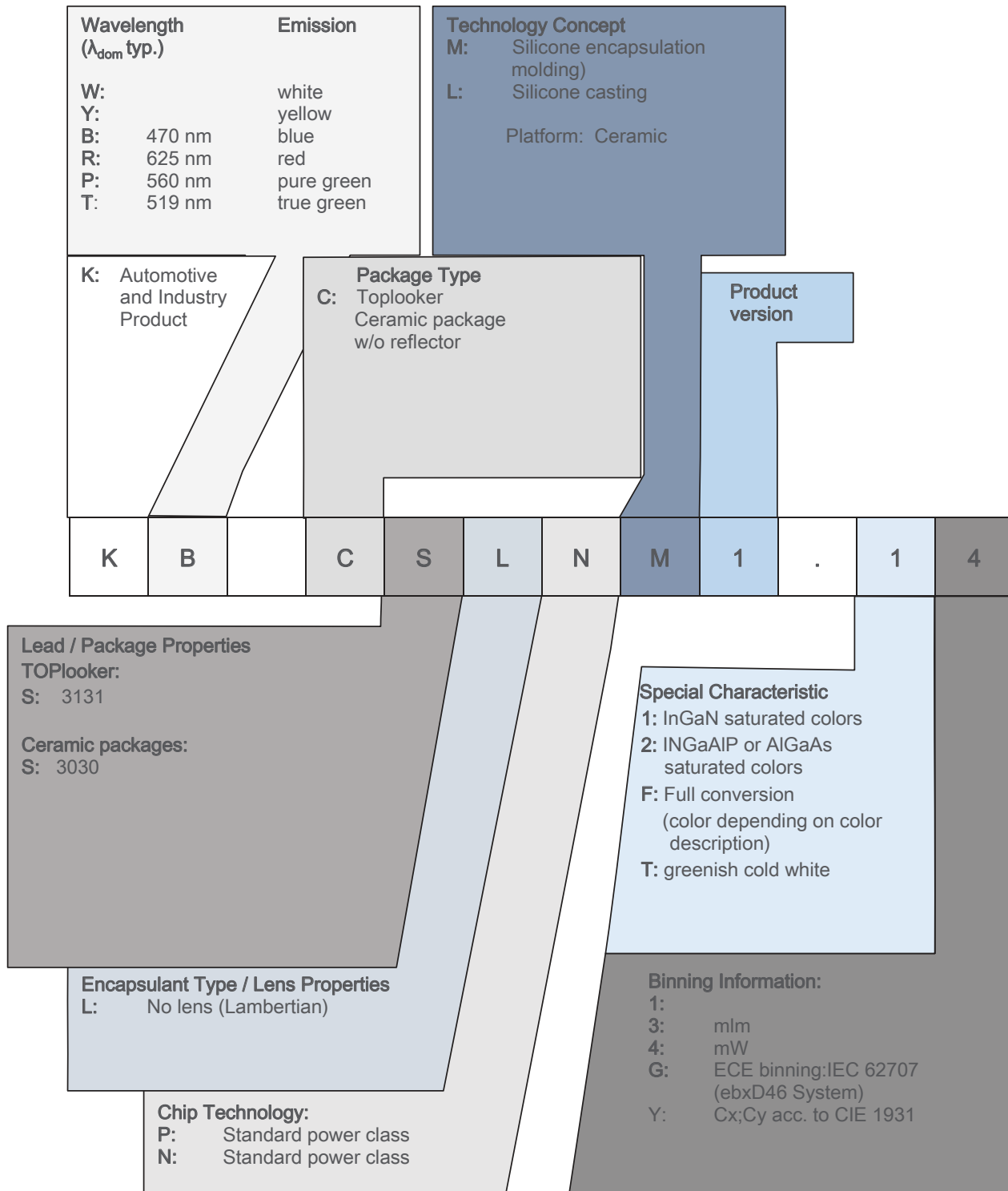

Notes

The evaluation of eye safety occurs according to the standard IEC 62471:2006 (photo biological safety of lamps and lamp systems). Within the risk grouping system of this IEC standard, the device specified in this data sheet fall into the class **moderate risk (exposure time 0.25 s)**. Under real circumstances (for exposure time, conditions of the eye pupils, observation distance), it is assumed that no endangerment to the eye exists from these devices. As a matter of principle, however, it should be mentioned that intense light sources have a high secondary exposure potential due to their blinding effect. When looking at bright light sources (e.g. headlights), temporary reduction in visual acuity and afterimages can occur, leading to irritation, annoyance, visual impairment, and even accidents, depending on the situation.

Subcomponents of this device contain, in addition to other substances, metal filled materials. Metal filled materials can be affected by environments that contain traces of aggressive substances. Therefore, we recommend that customers avoid device exposure to aggressive substances during storage, production, and use.

For further application related information please visit www.osram-os.com/appnotes

Disclaimer

Attention please!

The information describes the type of component and shall not be considered as assured characteristics. Terms of delivery and rights to change design reserved. Due to technical requirements components may contain dangerous substances.

For information on the types in question please contact our Sales Organization.

If printed or downloaded, please find the latest version on our website.

Packing

Please use the recycling operators known to you. We can also help you – get in touch with your nearest sales office. By agreement we will take packing material back, if it is sorted. You must bear the costs of transport. For packing material that is returned to us unsorted or which we are not obliged to accept, we shall have to invoice you for any costs incurred.

Product and functional safety devices/applications or medical devices/applications

Our components are not developed, constructed or tested for the application as safety relevant component or for the application in medical devices.

Our products are not qualified at module and system level for such application.

In case buyer – or customer supplied by buyer – considers using our components in product safety devices/ applications or medical devices/applications, buyer and/or customer has to inform our local sales partner immediately and we and buyer and /or customer will analyze and coordinate the customer-specific request between us and buyer and/or customer.

Glossary

- 1) **Brightness:** Brightness values are measured during a current pulse of typically 25 ms, with an internal reproducibility of $\pm 8\%$ and an expanded uncertainty of $\pm 11\%$ (acc. to GUM with a coverage factor of $k = 3$).
- 2) **Reverse Operation:** This product is intended to be operated applying a forward current within the specified range. Applying any continuous reverse bias or forward bias below the voltage range of light emission shall be avoided because it may cause migration which can change the electro-optical characteristics or damage the LED.
- 3) **Wavelength:** The wavelength is measured at a current pulse of typically 25 ms, with an internal reproducibility of ± 0.5 nm and an expanded uncertainty of ± 1 nm (acc. to GUM with a coverage factor of $k = 3$).
- 4) **Forward Voltage:** The forward voltage is measured during a current pulse of typically 8 ms, with an internal reproducibility of ± 0.05 V and an expanded uncertainty of ± 0.1 V (acc. to GUM with a coverage factor of $k = 3$).
- 5) **Thermal Resistance:** $R_{th\ max}$ is based on statistic values (6σ).
- 6) **Typical Values:** Due to the special conditions of the manufacturing processes of semiconductor devices, the typical data or calculated correlations of technical parameters can only reflect statistical figures. These do not necessarily correspond to the actual parameters of each single product, which could differ from the typical data and calculated correlations or the typical characteristic line. If requested, e.g. because of technical improvements, these typ. data will be changed without any further notice.
- 7) **Characteristic curve:** In the range where the line of the graph is broken, you must expect higher differences between single devices within one packing unit.
- 8) **Tolerance of Measure:** Unless otherwise noted in drawing, tolerances are specified with ± 0.1 and dimensions are specified in mm.
- 9) **Tape and Reel:** All dimensions and tolerances are specified acc. IEC 60286-3 and specified in mm.

Revision History

Version	Date	Change
1.7	2019-01-07	Additional Information
1.8	2020-07-17	Ordering Information
1.9	2021-09-13	Applications
1.9	2021-09-21	Derating (Diagrams)
1.10	2022-04-14	Ordering Information Maximum Ratings New Layout



EU RoHS and China RoHS compliant product

此产品符合欧盟 RoHS 指令的要求；
按照中国的相关法规和标准，
不含有毒有害物质或元素。

Published by ams-OSRAM AG

Tobelbader Strasse 30, 8141 Premstaetten, Austria

Phone +43 3136 500-0

ams-osram.com

© All rights reserved

am 

OSRAM