

TRACE PATTERN
SCALE 1:1

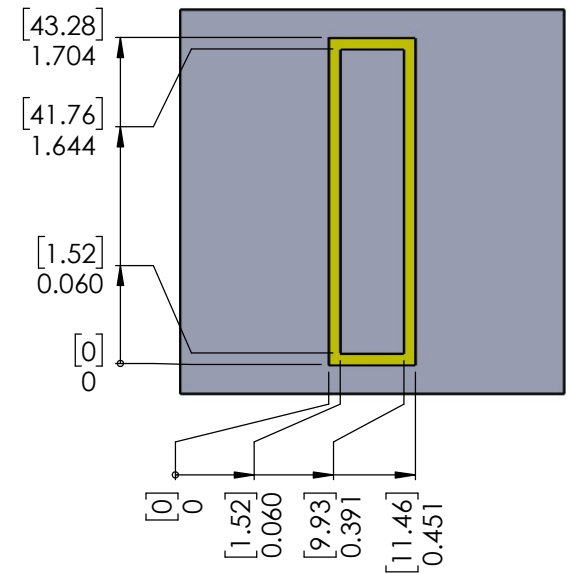
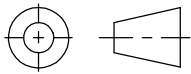

RoHS Compliant		NAME		DATE	
THIRD ANGLE PROJECTION 		DRAWN		9/29/2010	
DO NOT SCALE DRAWING		CHECKED			
PROPRIETARY AND CONFIDENTIAL THE INFORMATION CONTAINED IN THIS DRAWING IS THE SOLE PROPERTY OF ORBEL CORPORATION. ANY REPRODUCTION IN PART OR AS A WHOLE WITHOUT THE WRITTEN PERMISSION OF ORBEL CORPORATION IS PROHIBITED.		MATERIAL:		MFG APPR.	
		.010" [0.254] NICKEL SILVER, 1/2 HARD		Q.A.	
		FINISH:		COMMENTS:	
		WEIGHT: 0.081oz [2.292g]			
		ORBEL		ENGINEERED SOLUTIONS	
		SIZE A DWG NO. G-0401SC1654-0250XC		REV. 01	
		SCALE: 2:1		CAGE CODE: 57DU2	
				SHEET 1 OF 1	

HOW TO ORDER BOARD LEVEL SHIELDING

The chart below is an easy-to-use reference on how Orbel BLS part numbers are created and used to order standard and custom board level shielding. Custom configurations that fall outside of our standard shield styles are also available.

Sample Part Number (Snap-Shield Bullzeze™): B-0750TB1125-0250XF - TPS



STANDARD FEATURES

PIN OPTIONS



Alignment Pin

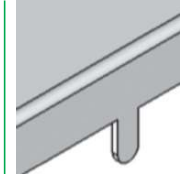

Through-Hole Pin

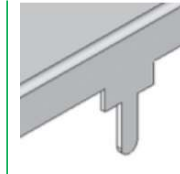

Through-Hole Pin with Standoff

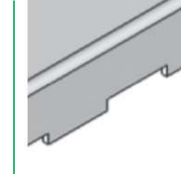

Castellation Edge

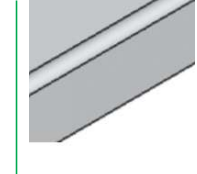

Straight Edge, No Pin

CORNER OPTIONS



Tight Corner

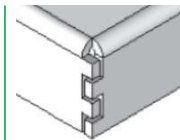

Louvered Corner

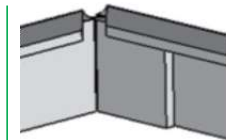

Welded Corner

ADDITIONAL OPTIONS



Trace Notch



Pick Target

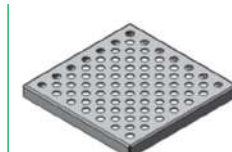

Ventilation Holes



Logo or Part Number Marking

PERFORMANCE SPECS

Material Options

- Nickel Silver
- TPS: Tin-Plated Steel
- TPB: Tin-Plated Brass
- TPC: Tin-Plated Copper

Co-Planarity

- Smaller Shields: 0.004"
- Larger Shields: 0.008"

Material Thicknesses

- 0.010" (Standard)
- 0.008"
- 0.012"
- 0.015"

RoHS-Compliant

- Yes

Shielding Effectiveness

- Up to 60dB

Other material options include beryllium copper, phosphorus bronze, and stainless steel. Additional plating finishes available upon request.

All technical data presented herein is accurate to the best of our knowledge based on Orbel's most up-to-date testing information and material specs. This information is not presented as a warranty or guarantee and is not intended to be all-inclusive as to conditions of use.