

# EVT026

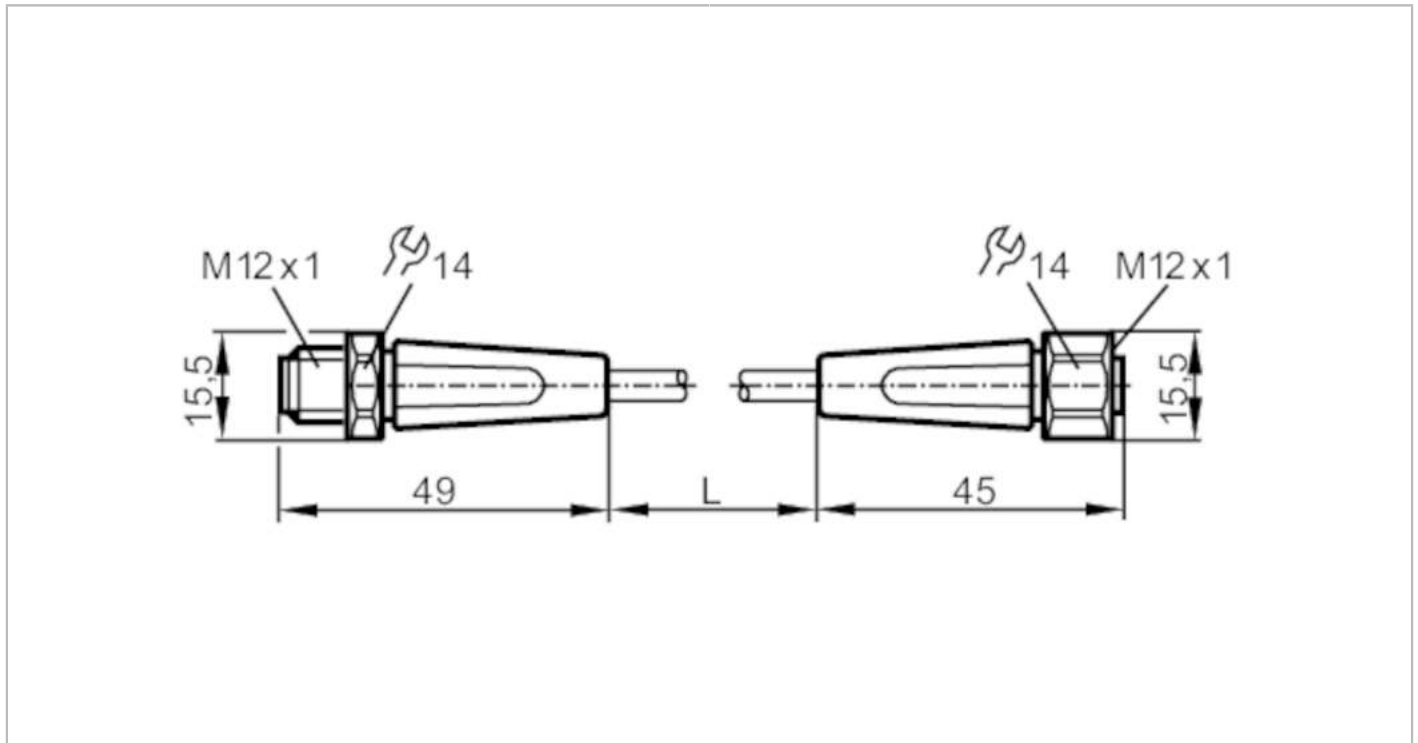

## Connection cable

VDOGH030VAS0005E03STGH030VAS



Application	
Special feature	Free from silicone; Gold-plated contacts; Drag chain suitability
Application	hygienic and wet areas in the food industry
Free from silicone	yes
Electrical data	
Operating voltage [V]	< 250 AC / < 300 DC
Protection class	II
Max. current load total [A]	4
Operating conditions	
Ambient temperature [°C]	-25...100
Note on ambient temperature	cULus: ...50
Ambient temperature (moving) [°C]	5...100
Note on ambient temperature (moving)	cULus: ...50
Storage temperature [°C]	-25...55
Storage humidity [%]	10...100
Other climatic conditions for storage according to stated class	1K22/ DIN 60721-3-1
Protection	IP 65; IP 67; IP 68; IP 69K
Mechanical data	
Weight [g]	194.3
Materials	housing: PVC orange; Sealing: EPDM
Material nut	stainless steel (1.4404 / 316L)

# EVT026



## Connection cable

VDOGH030VAS0005E03STGH030VAS

Drag chain suitability	yes	
Drag chain suitability	bending radius for flexible use	min. 10 x cable diameter
	travel speed	max. 3.3 m/s for a horizontal travel length of 5 m and max. acceleration of 5 m/s <sup>2</sup>
	bending cycles	> 1 Mio.
	torsional strain	± 180 °/m

### Remarks

Pack quantity	1 pcs.
---------------	--------

### Electrical connection - plug

Connector: 1 x M12, straight; coding: A; Locking: stainless steel (1.4404 / 316L); Contacts: gold-plated; Tightening torque: 0.6...1.5 Nm

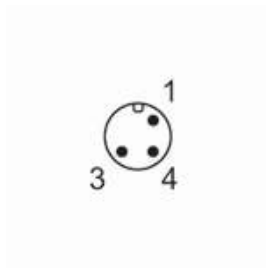

### Electrical connection

Cable: 5 m, PVC, orange, Ø 4.9 mm; 3 x 0.34 mm<sup>2</sup> (42 x Ø 0.1 mm )

### Connection

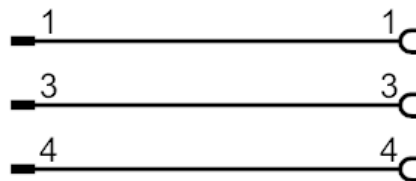

### Electrical connection - socket

Connector: 1 x M12, straight; coding: A; Locking: stainless steel (1.4404 / 316L); Contacts: gold-plated; Tightening torque: 0.6...1.5 Nm

