

# TL70 Pro Tower Light with IO-Link

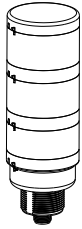

## Datasheet

70 mm IO-Link Controlled Modular Multicolor RGB Tower Light



- Modular, IO-Link controlled LED indicator with extremely bright and uniform light
- Illuminated segments provide easy-to-see operator guidance and indication of equipment status
- IO-Link gives full access to color, flashing, and dimming settings, as well as advanced animations like run and level modes which provides dynamic response to changing machine conditions
- Multiple audible options available
- 18 V DC to 30 V DC operation
- Up to six segments, or five segments plus audible, in one device
- Modularity gives the user flexibility to customize tower lights as needed and change positions in the field
- Also available preassembled for easy installation

## Models

### TL70 Pro with IO-Link Base

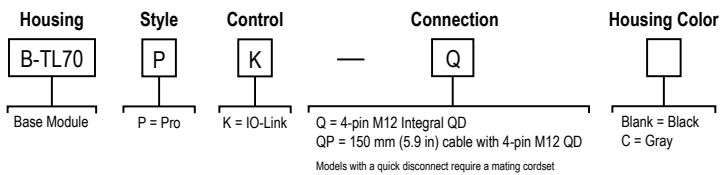

### TL70 Pro Segments

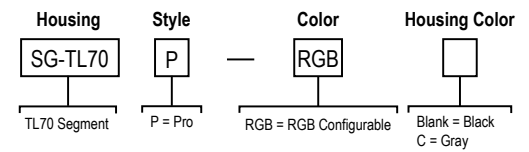

- Example base model number: B-TL70PK-Q
- Example light segment model number: SG-TL70P-RGB

### TL70 Pro with IO-Link Pre-Assembled Models

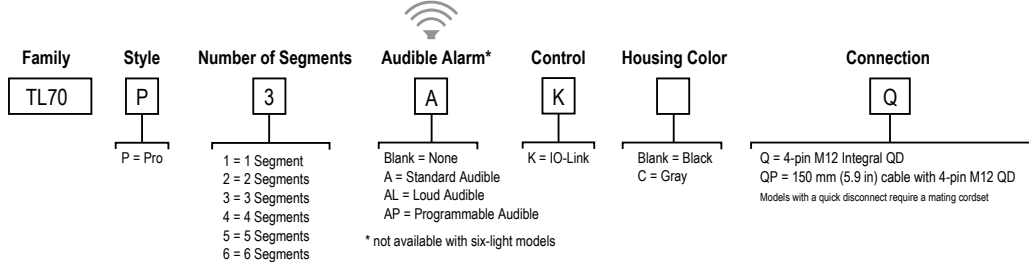

- Example pre-assembled model number: TL70P4ALKCQP

## Configuring the Module Position

Turn on the appropriate DIP switch to set the order of the components, counting up from the tower light's base. Factory default DIP position is OFF for segments ordered individually.

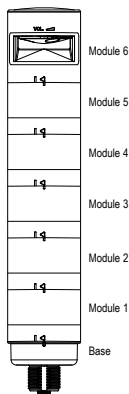

Assembly Options		DIP Switches							
		1	2	3	4	5	6	7	8
Position	Module 1	ON							
	Module 2		ON						
	Module 3			ON					
	Module 4				ON				
	Module 5					ON			
	Module 6*						ON		
Standard Audible Module Settings	Pulse 1.5 Hz							ON	OFF
	Chirp Alarm							ON	ON
	Siren Alarm							OFF	ON
	Continuous Alarm*							OFF	OFF



**Note:** Audible modules must be configured as module position 6.



Assembly Options		DIP Switches									
		1	2	3	4	5	6	7	8	9	10
Loud Audible Module Settings	Pulse 1.5 Hz							ON	OFF		
	Chirp Alarm							ON	ON		
	Siren Alarm							OFF	ON		
	Continuous Alarm*							OFF	OFF		
	Low Intensity*									OFF	OFF
	Med. Intensity									ON	OFF
	Med./Loud Intensity									OFF	ON
Loud Intensity									ON	ON	

\* Factory default setting

## Programming the Audible Tower Module

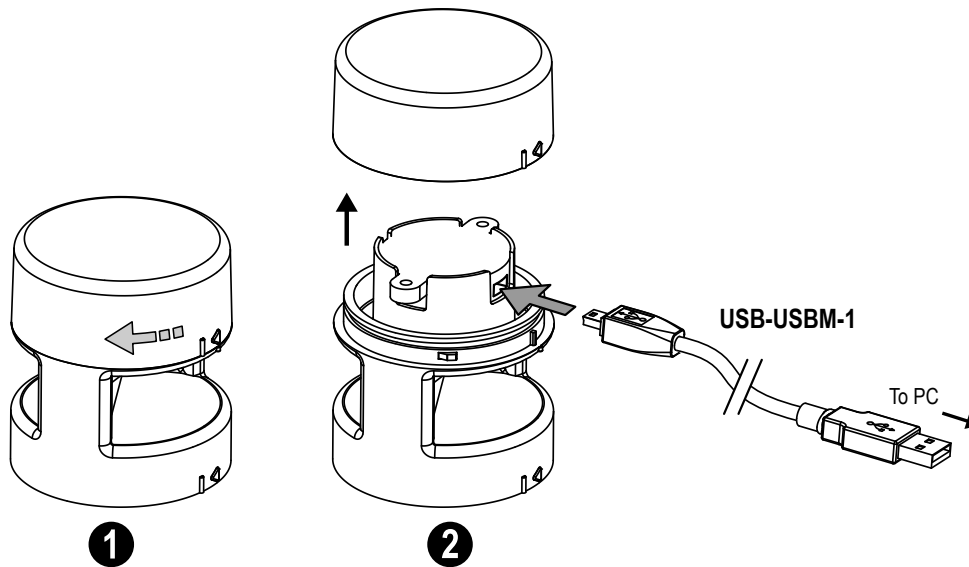

### Loading Files into the SG-TL70-AP

The SG-TL7-AP has 4MB of on-board flash memory and can playback any WAV or MP3 audio file that is 4MB or smaller. If the file is too large, a program such as Audacity can be used to compress or shorten the file to decrease the size.

Multiple files can be loaded onto the SG-TL70-AP. Files playback according to the file name in alpha-numeric order.



**Note:** Add a number to the beginning of the file name to create the order in which the files run. Files play consecutively without any pause.

To program the module:

1. Remove the module top cover by rotating counterclockwise.
2. Connect the programming cable (USB-USBM-1) from the PC's USB connection to the USB mini-connection of the audible module. The SG-TL70-AP is recognized by the PC as a USB flash drive. The default drivers for a USB drive are assigned to the device, as well as a unique disk drive letter assignment (such as D:).
3. Drag-and-drop the audio files that are saved on the PC to the USB drive location.
4. Assign numbers to each file to designate their playback order, otherwise files playback in alpha-numeric order.
5. Remove the cable from the audio module.
6. Re-install the top cover by aligning the protruding alignment marks and turning clockwise.
7. The audible module is now ready for use with a compatible TL70 DC Base or Universal Voltage AC Base.

When the selected Input Channel is activated, the audible module begins playing the files in sequential order.

## Assembling the Modules

Figure 1. Assembling the modules

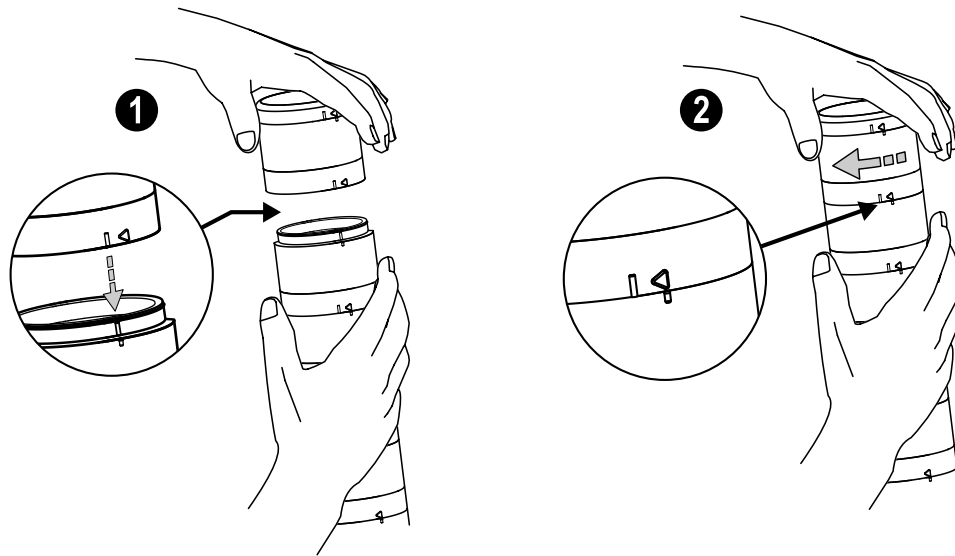

To assemble the modules:

1. Align the notches on each module and press together.
2. Rotate the top module clockwise to lock into place (notches shown in the locked position).

## Wiring Diagram

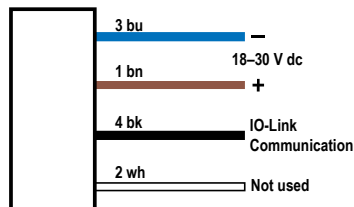

### Key

- 1 = Brown
- 2 = White
- 3 = Blue
- 4 = Black

## IO-Link Process Data Out (Master to Device)

IO-Link® is a point-to-point communication link between a master device and a sensor and/or light. It can be used to automatically parameterize sensors or lights and to transmit process data. For the latest IO-LINK protocol and specifications, please visit [www.io-link.com](http://www.io-link.com).

For the latest IODD files, please refer to the Banner Engineering Corp website at: [www.bannerengineering.com](http://www.bannerengineering.com).

### Basic Segment Mode

Use process data to set each segment to off, solid on, flash, or animation mode. Use parameter data to change color, intensity, flash speed, and select animation type.

### Advanced Segment Mode

Use process data to activate each segment and control color, intensity, flash, and other animation types. Use parameter data to create custom colors, intensity, and flash speeds.

### Run Mode

Use process data to control entire tower light and select color, intensity, flash and run mode animations. Use parameter data to create custom colors, intensity, and flash speeds.

Run Mode and Segment Mode Animations	
Animation	Description
Off	Segment is off
Steady	Color 1 is solid on at defined intensity
Flash	Color 1 flashes at defined speed, color intensity, and pattern (normal, strobe, three pulse, SOS, or random)
Two Color Flash	Color 1 and Color 2 flash alternately at defined speed, color intensities, and pattern (normal, strobe, three pulse, SOS, or random)
Intensity Sweep	Color 1 repeatedly increases and decreases intensity between 0% to 100% at defined speed and color intensity
Two Color Sweep	Color 1 and Color 2 define the end values of a line across the color gamut. The segment continuously displays a color by moving along the line at the defined speed and color intensities
Spectrum	The segment scrolls through 13 predefined colors with a different color on each LED at the defined speed, Color 1 intensity, and direction
Two Color Shift	Color 1 and Color 2 flash alternately on adjacent segments at defined speed and color intensities (Run Mode Only)

Run Mode and Segment Mode Animations	
Animation	Description
<b>Scroll</b>	Color 1 fills the segment as defined by Percent Width of Color 1 and moves in one direction up or down against the background of Color 2 at the defined speed, color intensities, style, and direction (Run Mode Only)
<b>Center Scroll</b>	Color 1 fills the segment as defined by Percent Width of Color 1 and moves in or out from the center of the segment against the background of Color 2 at the defined speed, color intensities, style, and direction (Run Mode Only)
<b>Bounce</b>	Color 1 fills the segment as defined by Percent Width of Color 1 and moves up and down against the background of Color 2 at the defined speed, color intensities, and style (Run Mode Only)
<b>Center Bounce</b>	Color 1 fills the segment as defined by Percent Width of Color 1 and moves in and out from the center of the segment against the background of Color 2 at the defined speed, color intensities, and style (Run Mode Only)
<b>Single End Steady</b>	Color 1 is solid ON at the defined intensity on one end of the device (Run Mode Only)
<b>Single End Flash</b>	Color 1 flashes at the defined speed, color intensity, and pattern (normal, strobe, three pulse, SOS, or random) on one end of the device (Run Mode Only)

### Level Mode

Use process data to set the level value. Use parameter data to set range, thresholds, colors, intensities, flash speeds, and animation types.

Level Mode Animations	
Animation	Description
<b>Level Mode Value</b>	Value of the level of the tower (between 0 to 65,535)
<b>Full Scale Value</b>	Set the upper limit of the Level Mode Value (between 0 to 65535)
<b>Threshold Type: None</b>	Level Mode Values are displayed on tower as defined by Base color, intensity, and state (steady or flashing).
<b>Threshold Type: Low</b>	Level Mode Values below Low Threshold Value are displayed on segments defined by Low Threshold color, intensity, and state (steady or flashing). Level Mode Values above Low Threshold Value are displayed on segments defined by Base color, intensity, and state (steady or flashing).
<b>Threshold Type: High</b>	Level Mode Values below High Threshold Value are displayed on segments defined by Base color, intensity, and state (steady or flashing). Level Mode Values above High Threshold Value are displayed on segments defined by High Threshold color, intensity, and state (steady or flashing).
<b>Threshold Type: High and Low</b>	Level Mode Values below Low Threshold Value are displayed on segments defined by Low Threshold color, intensity, and state (steady or flashing). Level Mode Values between Low and High Threshold Values are displayed on segments defined by Base color, intensity, and state (steady or flashing). Level Mode Values above High Threshold Value are displayed on segments defined by High Threshold color, intensity, and state (steady or flashing).
<b>Base, Low Threshold, High Threshold, and Background</b>	Colors, Intensities, and States - Set the colors, intensities, and states (steady or flash) the tower will display if the Level Mode Value conforms to the defined threshold type
<b>Dominance</b>	If Non-Dominant is defined, segments display their defined threshold color; if Dominant is defined, all segments display the active threshold color
<b>Segment Style</b>	If Level Mode Value is a partial percentage of a segment, select if segment will be on steady, flashing, or analog dimmed to the partial percentage

### Gauge Mode

Gauge mode uses the light to display a colored band of LEDs in a position proportional to the gauge mode value.

Use process data to set the gauge mode value. Use parameter data to set range, thresholds, colors, intensities, flash speeds, background, threshold markers, and animation types.

Gauge Mode Settings	
General Settings	Description
Gauge Mode Value	Value of the band position within the light (between 0 to 65,535)
Full Scale Value	Set the upper limit of the Gauge Mode Value (between 0 to 65,535)
Filtering	Smooths the input signal by varying the sample size None: There is no filtering Low: The sample size is short and changes to the input signal are more noticeable High: The sample size is long and changes to the input signal are less noticeable
Hysteresis	Determines the signal value change needed to transition between thresholds and to prevent chatter None: The value follows the input signal High: A large value change is needed to transition between thresholds
Gauge Mode Threshold Markers	Threshold markers display LED(s) at the defined thresholds and can be configured as either dominant or non-dominant. Threshold marker location and width are defined by the offset and width parameter, respectively, in segment mode.

Center, Threshold 1, and Threshold 2 Settings	Description
Threshold Type: Center	Gauge Mode Values not in Threshold 1 or Threshold 2 are positioned on a band of LEDs as defined by the center threshold color, intensity, flash speeds, backgrounds, band size percent width, and run mode animation types
Threshold Type: 1 & 2	Gauge Mode Values that conform to Threshold Comparison Type $\leq$ or $\geq$ and the Threshold Value Percent are positioned on a band of LEDs as defined by the threshold color, intensity, flash speeds, backgrounds, band size percent width, and run mode animation types

## Specifications

### Supply Voltage and Current

18 V DC to 30 V DC

Indicator Color or Audible Model	Maximum Current (mA)		
	at 18 V DC	at 24 V DC	at 30 V DC
RGB Segment	216	156	127
Standard Audible	31	30	30
Loud Audible (Intensity 1)	24	21	19
Loud Audible (Intensity 2)	38	34	32
Loud Audible (Intensity 3)	96	75	63
Loud Audible (Intensity 4)	153	115	96
Programmable Audible	145	112	97

### Supply Protection Circuitry

Protected against reverse polarity and transient voltages

### Audible Alarm

**Standard Audible:** 2.6 kHz  $\pm$  250 Hz oscillation frequency; maximum intensity (typical) 92 dB at 1 m (3.3 ft)

**Loud Audible:** 2.6 kHz  $\pm$  250 Hz oscillation frequency; maximum intensity (typical) at 1 m (3.3 ft) (see table)



**Note:** Audible module position must be configured as Module 6

DIP Switches		Max Intensity (Loud Audible)
9	10	
ON	ON	Intensity 4: 101 dB
OFF	ON	Intensity 3: 99 dB
ON	OFF	Intensity 2: 92 dB
OFF	OFF	Intensity 1: 85 dB

### Audible Adjustment

**Standard Audible:** Rotate the cover until the desired volume is reached

**Loud Audible Alarm:** Select the desired volume using DIP switches 9 and 10

**Typical Reduction in Sound Intensity with Audible Adjustment (maximum to minimum):**

- **Standard Audible:** 8 dB
- **Loud Audible:** 16 dB

### Certifications



**Banner Engineering Europe** Park Lane, Culliganlaan 2F bus 3, 1831 Diegem, BELGIUM



**Turck Banner LTD** Blenheim House, Blenheim Court, Wickford, Essex SS11 8YT, Great Britain



### Input Response Time

Indicator On/Off Response Time: 20 ms (maximum)

### Connections

Integral 4-pin M12 male quick-disconnect connector; 150 mm (6 in) PVC-jacketed cable with a 4-pin M12 male quick-disconnect connector

### Construction

Bases, Covers, Light Segment: Polycarbonate

### Operating Conditions

-40 °C to +50 °C (-40 °F to +122 °F)

95% at +50 °C maximum relative humidity (non-condensing)

### Environmental Rating

IP65, UL Type 1

### Vibration and Mechanical Shock

Vibration: 10 Hz to 55 Hz, 0.5 mm peak-to-peak amplitude per IEC 60068-2-6

Shock: 15G 11 ms duration, half sine wave per IEC 60068-2-27

### Required Overcurrent Protection



**WARNING:** Electrical connections must be made by qualified personnel in accordance with local and national electrical codes and regulations.

Overcurrent protection is required to be provided by end product application per the supplied table.

Overcurrent protection may be provided with external fusing or via Current Limiting, Class 2 Power Supply.

Supply wiring leads < 24 AWG shall not be spliced.

For additional product support, go to [www.bannerengineering.com](http://www.bannerengineering.com).

Supply Wiring (AWG)	Required Overcurrent Protection (Amps)
20	5.0
22	3.0
24	2.0
26	1.0
28	0.8
30	0.5

### Indicator Characteristics

Color	Dominant Wavelength (nm) or Color Temperature (CCT)	Color Coordinates <sup>1</sup>		Lumen Output (Typical at 25 °C)
		x	y	
Red	622	0.694	0.304	27.4
Green	527	0.177	0.707	69.0
Yellow	575	0.456	0.489	46.6
Blue	472	0.128	0.080	17.4
Magenta	-	0.371	0.176	24.0
Cyan	493	0.161	0.347	49.5
White	5600 K	0.310	0.335	40.9
Amber	589	0.542	0.422	39.9
Rose	-	0.497	0.226	26.6
Lime Green	561	0.369	0.556	53.8
Orange	600	0.606	0.372	35.5
Sky Blue	486	0.146	0.251	41.7
Violet	-	0.222	0.117	21.3
Spring Green	508	0.166	0.531	62.4

<sup>1</sup> Refer to CIE 1931 chromaticity diagram or color chart, to show equivalent color with indicated color coordinates.

## Dimensions

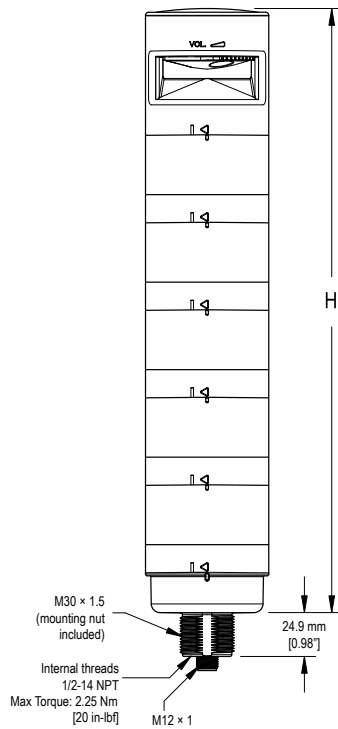

Model	Height (H)
1 light module	87.6 mm (3.45 in)
1 light module, 1 audible module	144.3 mm (5.68 in)
2 light modules	137.3 mm (5.41 in)
2 light modules, 1 audible module	194 mm (7.64 in)
3 light modules	187 mm (7.36 in)
3 light modules, 1 audible module	243.7 mm (9.59 in)
4 light modules	236.7 mm (9.32 in)
4 light modules, 1 audible module	293.4 mm (11.55 in)
5 light modules	286.4 mm (11.28 in)
5 light modules, 1 audible module	343.1 mm (13.5 in)

## Accessories

### Cordsets

4-Pin Threaded M12 Cordsets—Double Ended				
Model	Length	Style	Dimensions	Pinout
MQDEC-401SS	0.31 m (1 ft)	Male Straight/Female Straight		Female
MQDEC-403SS	0.91 m (2.99 ft)			
MQDEC-406SS	1.83 m (6 ft)			Male
MQDEC-412SS	3.66 m (12 ft)			
MQDEC-420SS	6.10 m (20 ft)			
MQDEC-430SS	9.14 m (30.2 ft)			
MQDEC-450SS	15.2 m (49.9 ft)			1 = Brown 2 = White 3 = Blue 4 = Black

## Mounting Brackets

All measurements are listed in millimeters [inches], unless noted otherwise.

### SMB30A

- Right-angle bracket with curved slot for versatile orientation
- Clearance for M6 (¼ in) hardware
- Mounting hole for 30 mm sensor
- 12-ga. stainless steel

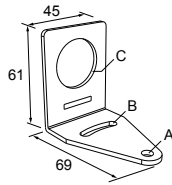

**Hole center spacing:** A to B=40  
**Hole size:** A=ø 6.3, B= 27.1 x 6.3, C=ø 30.5

### SMB30FA

- Swivel bracket with tilt and pan movement for precise adjustment
- Mounting hole for 30 mm sensor
- 12-ga. 304 stainless steel
- Easy sensor mounting to extrude rail T-slot
- Metric and inch size bolt available

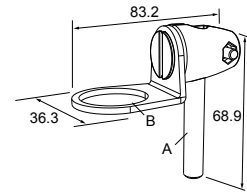

**Bolt thread:** SMB30FA, A= 3/8 - 16 x 2 in; SMB30FAM10, A= M10 - 1.5 x 50  
**Hole size:** B= ø 30.1

### SMB30MM

- 12-ga. stainless steel bracket with curved mounting slots for versatile orientation
- Clearance for M6 (¼ in) hardware
- Mounting hole for 30 mm sensor

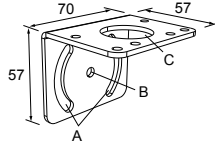

**Hole center spacing:** A = 51, A to B = 25.4  
**Hole size:** A = 42.6 x 7, B = ø 6.5, C = ø 30.1

### SMBAMS30P

- Flat SMBAMS series bracket
- 30 mm hole for mounting sensors
- Articulation slots for 90°+ rotation
- 12-ga. 300 series stainless steel

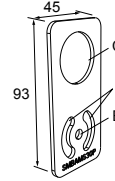

**Hole center spacing:** A=26.0, A to B=13.0  
**Hole size:** A=26.8 x 7.0, B=ø 6.5, C=ø 31.0

### SMBAMS30RA

- Right-angle SMBAMS series bracket
- 30 mm hole for mounting sensors
- Articulation slots for 90°+ rotation
- 12-ga. (2.6 mm) cold-rolled steel

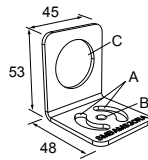

**Hole center spacing:** A=26.0, A to B=13.0  
**Hole size:** A=26.8 x 7.0, B=ø 6.5, C=ø 31.0

### SMB30SC

- Swivel bracket with 30 mm mounting hole for sensor
- Black reinforced thermoplastic polyester
- Stainless steel mounting and swivel locking hardware included

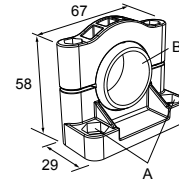

**Hole center spacing:** A=ø 50.8  
**Hole size:** A=ø 7.0, B=ø 30.0

### LMBE12RA35

- Direct mounting of stand-off pipe, with common bracket type
- Zinc-plated steel
- 1/2-14 NPSM nut
- Mounting distance from the wall to the center of the 1/2-14 NPSM nut is 35 mm

Hole center spacing: 20.0

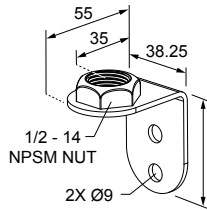

### LMBE12RA45

- Direct mounting of stand-off pipe, with common bracket type
- Zinc-plated steel
- 1/2-14 NPSM nut
- Mounting distance from the wall to the center of the 1/2-14 NPSM nut is 45 mm

Hole center spacing: 35.0

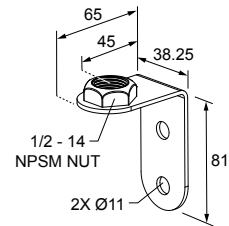



## LMB Sealed Right-Angle Bracket

Model	Description	Construction	
LMB30RA	<b>Direct-Mount Models:</b> Bracket kit with base, 30 mm adapter, set screw, fasteners, O-rings, and gaskets.	Black polycarbonate	
LMB30RAC		Gray polycarbonate	
LMBE12RA	<b>Pipe-Mount Models:</b> Bracket kit with base, ½-14 pipe adapter, set screw, fasteners, O-rings, and gaskets. For use with stand-off pipe (listed and sold separately).	Black polycarbonate	
LMBE12RAC		Gray polycarbonate	

## Elevated Mount System

Model	Features	Components
SA-M30 - Black Polycarbonate	<ul style="list-style-type: none"> <li>• Streamlined black PC or Gray PC thread cover</li> <li>• Covers M30 thread on the light base</li> <li>• Mounting hardware included</li> </ul>	
SA-M30C - Gray Polycarbonate		

Model			Features	Components
<b>Polished 304 Stainless Steel</b>	<b>Black Anodized Aluminum</b>	<b>Clear Anodized Aluminum</b>	<ul style="list-style-type: none"> <li>Elevated-use stand-off pipe (½ in. NPSM/DN15)</li> <li>Polished 304 stainless steel, black anodized aluminum, or clear anodized aluminum surface</li> <li>½ in. NPT thread at both ends</li> <li>Compatible with most industrial environments</li> </ul>	
<b>SOP-E12-150SS</b> 150 mm (6 in) long	<b>SOP-E12-150A</b> 150 mm (6 in) long	<b>SOP-E12-150AC</b> 150 mm (6 in) long		
<b>SOP-E12-300SS</b> 300 mm (12 in) long	<b>SOP-E12-300A</b> 300 mm (12 in) long	<b>SOP-E12-300AC</b> 300 mm (12 in) long		
<b>SOP-E12-900SS</b> 900 mm (36 in) long	<b>SOP-E12-900A</b> 900 mm (36 in) long	<b>SOP-E12-900AC</b> 900 mm (36 in) long		
<b>SA-E12M30 - Black Acetal</b>			<ul style="list-style-type: none"> <li>Streamlined black acetal or white UHMW mounting base adapter/cover</li> <li>Connects between ½ in. NPSM/DN15 pipe and 30 mm (1-3/16 in) drilled hole</li> <li>Mounting hardware included</li> </ul>	
<b>SA-E12M30C - White UHMW</b>				

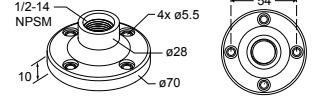
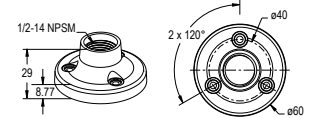
Pipe Mounting Flange			
Model	Features	Construction	
<b>SA-F12</b>	<ul style="list-style-type: none"> <li>Elevated-use stand-off pipes (½ in, NPSM/DN15)</li> <li>M5 mounting hardware and nitrile gasket included</li> </ul>	Die-cast zinc base with black paint	
<b>SA-F12-3</b>	<ul style="list-style-type: none"> <li>Elevated-use stand-off pipes (½ in, NPSM/DN15)</li> <li>M4 mounting hardware and nitrile blend gasket included</li> </ul>	Black Polycarbonate	

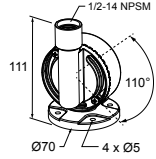
Foldable Mounting Brackets			
Model	Features	Construction	
<b>SA-FFB12</b>		Black polycarbonate	
<b>SA-FFB12C</b>	<ul style="list-style-type: none"> <li>For use with 1/2 inch stand-off pipes</li> <li>Stainless steel hardware</li> </ul>	Gray polycarbonate	

## Banner Engineering Corp. Limited Warranty

Banner Engineering Corp. warrants its products to be free from defects in material and workmanship for one year following the date of shipment. Banner Engineering Corp. will repair or replace, free of charge, any product of its manufacture which, at the time it is returned to the factory, is found to have been defective during the warranty period. This warranty does not cover damage or liability for misuse, abuse, or the improper application or installation of the Banner product.

**THIS LIMITED WARRANTY IS EXCLUSIVE AND IN LIEU OF ALL OTHER WARRANTIES WHETHER EXPRESS OR IMPLIED (INCLUDING, WITHOUT LIMITATION, ANY WARRANTY OF MERCHANTABILITY OR FITNESS FOR A PARTICULAR PURPOSE), AND WHETHER ARISING UNDER COURSE OF PERFORMANCE, COURSE OF DEALING OR TRADE USAGE.**

This Warranty is exclusive and limited to repair or, at the discretion of Banner Engineering Corp., replacement. **IN NO EVENT SHALL BANNER ENGINEERING CORP. BE LIABLE TO BUYER OR ANY OTHER PERSON OR ENTITY FOR ANY EXTRA COSTS, EXPENSES, LOSSES, LOSS OF PROFITS, OR ANY INCIDENTAL, CONSEQUENTIAL OR SPECIAL DAMAGES RESULTING FROM ANY PRODUCT DEFECT OR FROM THE USE OR INABILITY TO USE THE PRODUCT, WHETHER ARISING IN CONTRACT OR WARRANTY, STATUTE, TORT, STRICT LIABILITY, NEGLIGENCE, OR OTHERWISE.**

Banner Engineering Corp. reserves the right to change, modify or improve the design of the product without assuming any obligations or liabilities relating to any product previously manufactured by Banner Engineering Corp. Any misuse, abuse, or improper application or installation of this product or use of the product for personal protection applications when the product is identified as not intended for such purposes will void the product warranty. Any modifications to this product without prior express approval by Banner Engineering Corp will void the product warranties. All specifications published in this document are subject to change. Banner reserves the right to modify product specifications or update documentation at any time. Specifications and product information in English supersede that which is provided in any other language. For the most recent version of any documentation, refer to: [www.bannerengineering.com](http://www.bannerengineering.com).

For patent information, see [www.bannerengineering.com/patents](http://www.bannerengineering.com/patents).

## FCC Part 15 Class B

This equipment has been tested and found to comply with the limits for a Class B digital device, pursuant to part 15 of the FCC Rules. These limits are designed to provide reasonable protection against harmful interference in a residential installation. This equipment generates, uses and can radiate radio frequency energy and, if not installed and used in accordance with the instructions, may cause harmful interference to radio communications. However, there is no guarantee that interference will not occur in a particular installation. If this equipment does cause harmful interference to radio or television reception, which can be determined by turning the equipment off and on, the user is encouraged to try to correct the interference by one or more of the following measures:

- Reorient or relocate the receiving antenna.
- Increase the separation between the equipment and receiver.
- Connect the equipment into an outlet on a circuit different from that to which the receiver is connected.
- Consult the dealer or an experienced radio/TV technician for help.

## Industry Canada

This device complies with CAN ICES-3 (B)/NMB-3(B). Operation is subject to the following two conditions: 1) This device may not cause harmful interference; and 2) This device must accept any interference received, including interference that may cause undesired operation.

Cet appareil est conforme à la norme NMB-3(B). Le fonctionnement est soumis aux deux conditions suivantes : (1) ce dispositif ne peut pas occasionner d'interférences, et (2) il doit tolérer toute interférence, y compris celles susceptibles de provoquer un fonctionnement non souhaité du dispositif.