



Product Name: UWB Chip Antenna – CR702

Part Number: H2UL6G1K2U0100

Features:

- Stable and reliable in performance
- 5G in the ultra slim and smallest chip antenna
- SMT processes compatible
- RoHS 2.0 Compliant

Applications:

- Automotive sensors
- Ultra-wideband radios
- Precision surveying
- Remote controls
- Centimeter Level Positioning

UWB Chip Antenna

MODEL: CR702

Version: B

I. Specifications:

Items	Specifications
Frequencies (MHz)	3300 ~ 5000
VSWR	<3 Typ.
Efficiency (%)	57 Typ.
Average Gain (dB)	-2.5 Typ.
Peak Gain (dBi)	2.1 Typ.
Ground Plane Dimensions	131 x 60 mm ² (Evaluation board)
Impedance (Ω)	50
Polarization	Linear Polarization

Mechanical Specifications	
Dimensions (mm)	7 (L) x 3 (W) x 1 (H)
Environmental Conditions	
Operation Temperature ($^{\circ}$ C)	-40 ~ +85
Storage Temperature ($^{\circ}$ C)	-5 ~ +40
Relative Humidity	10 ~ 70 %

© Unictron Technologies Corp.
All specifications subject to change without notice.

II. Layout Guide(Unit : mm):

Solder Land Pattern:

The solder land pattern (gold marking areas) is shown below. Recommendation on matching circuit will be provided according to customer's installation conditions.

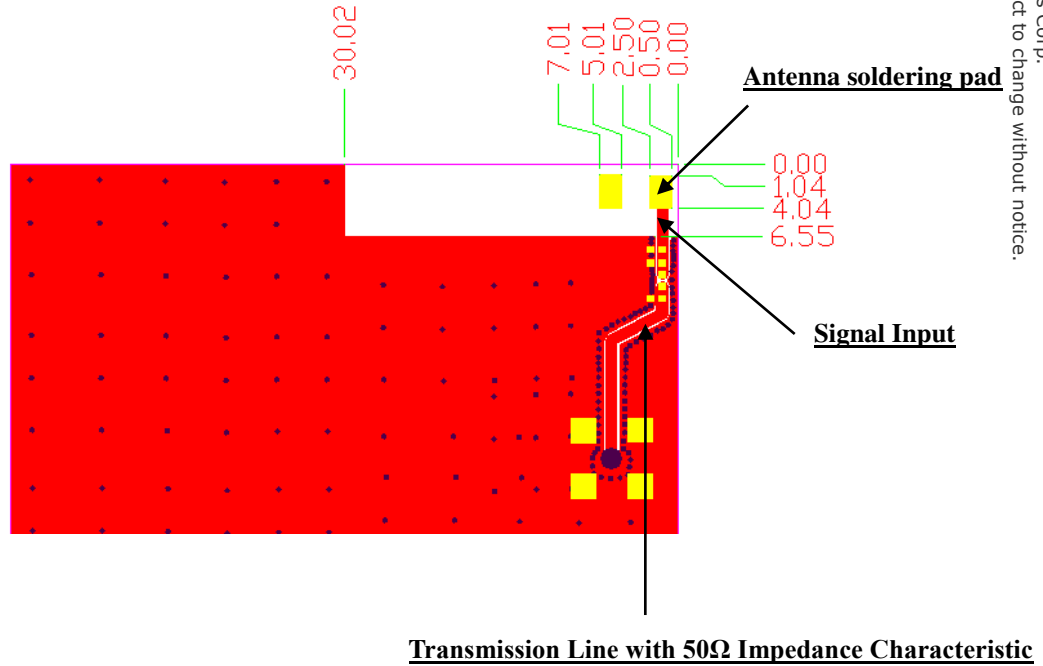

© Unictron Technologies Corp.
All specifications subject to change without notice.

Top View

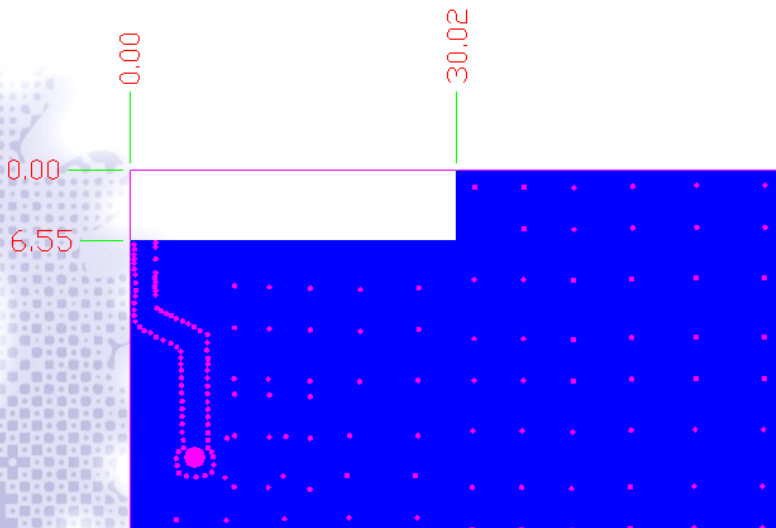

Bottom View

III. Mechanical Dimensions(Unit : mm):

a) Antenna Dimensions

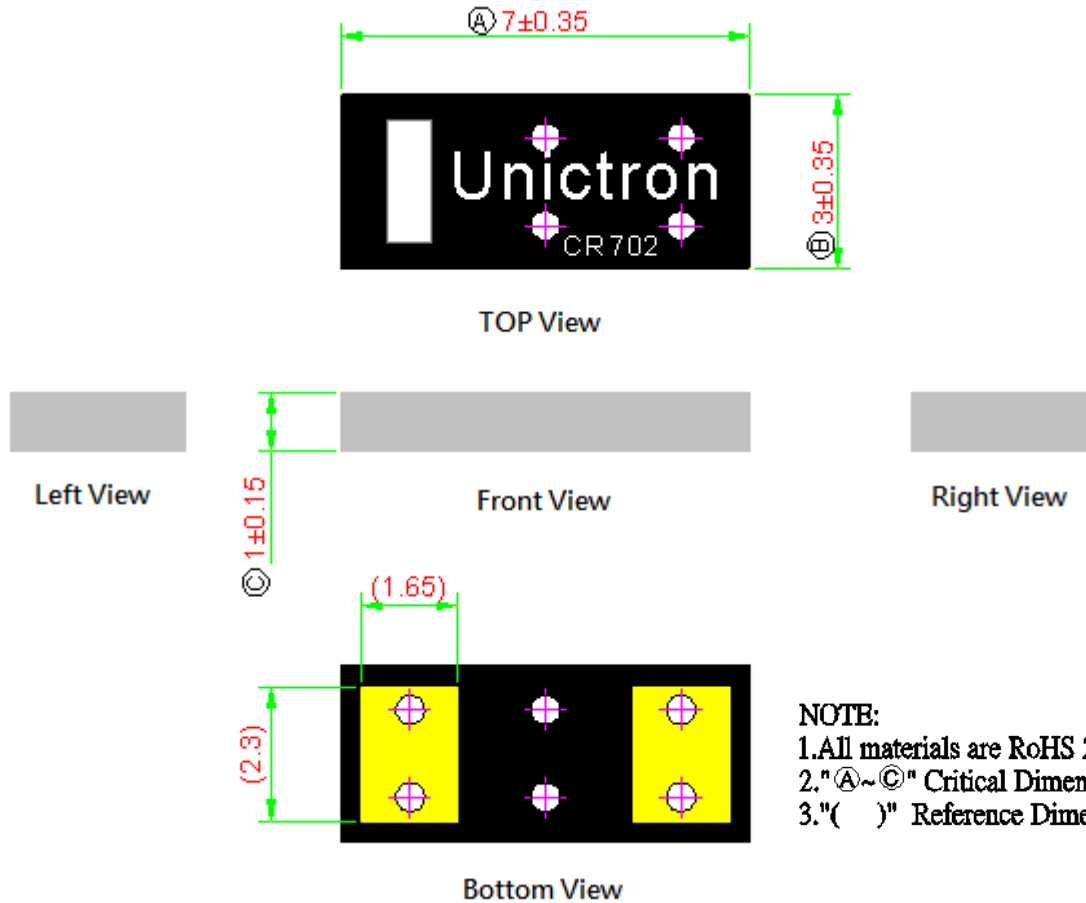

NOTE:
 1. All materials are RoHS 2.0 compliant.
 2. "A~C" Critical Dimensions.
 3. "()" Reference Dimensions.

© Unictron Technologies Corp.
 All specifications subject to change without notice.

b) PIN Definition



PIN	1	2
Soldering PAD	Signal	N/A

c) Direction of antenna signal feed-in

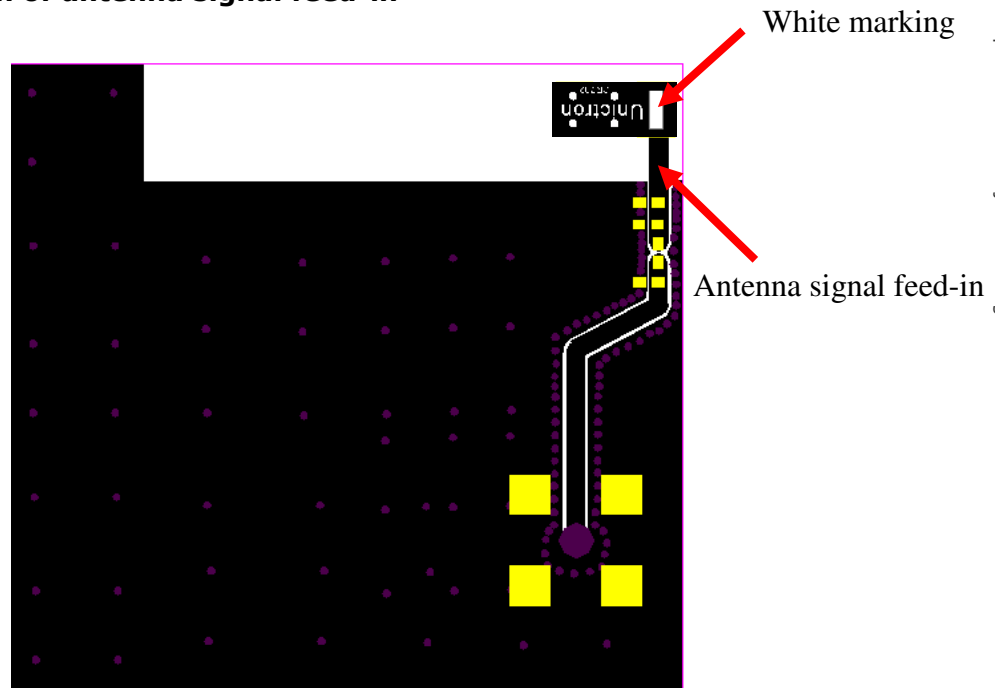

© Unictron Technologies Corp.
All specifications subject to change without notice.

d) Evaluation Board with Antenna

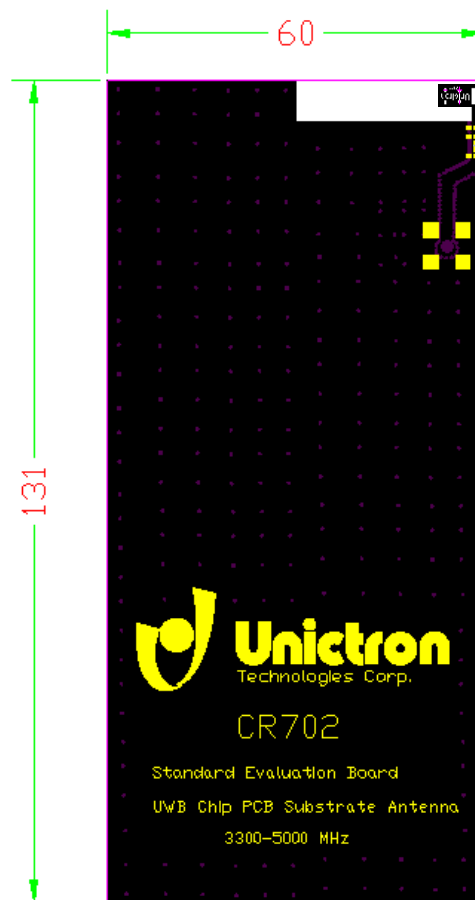

IV. Properties:

a) VSWR

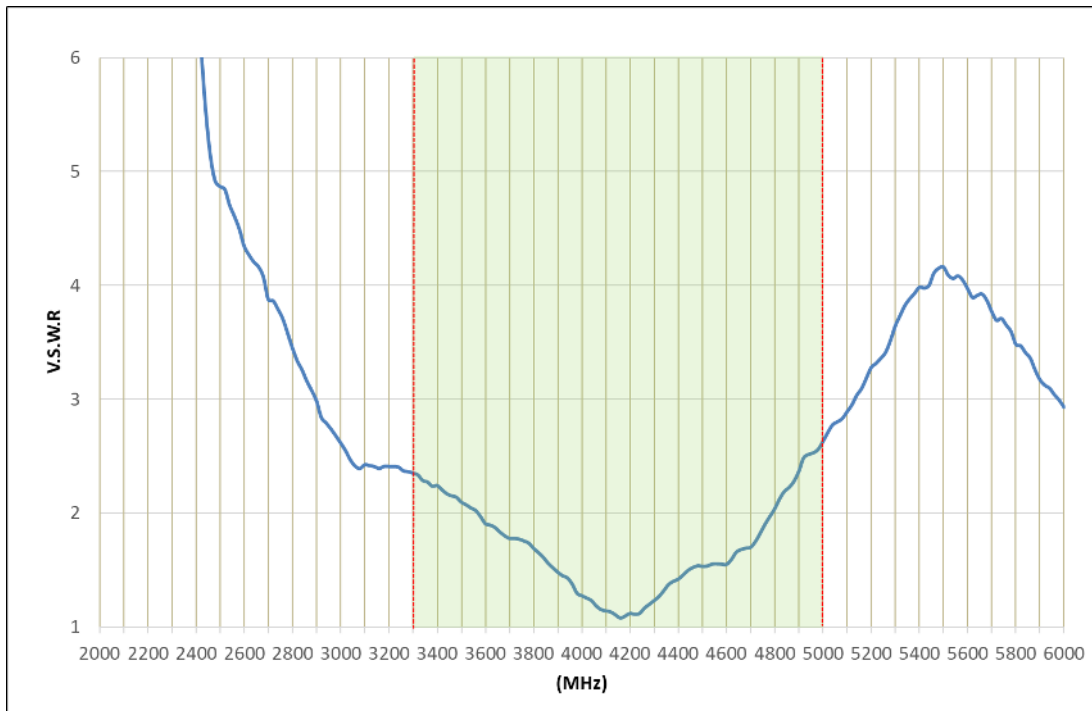

b) Efficiency (%)

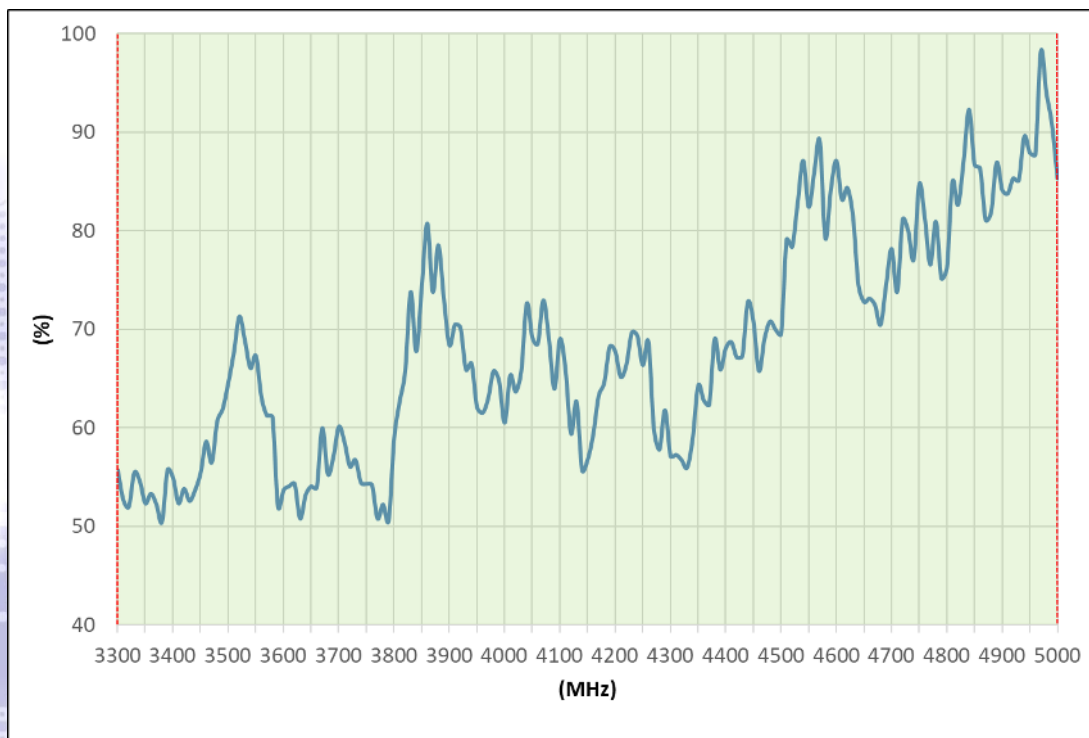

© Unictron Technologies Corp.
All specifications subject to change without notice.

c) Average Gain (dB)

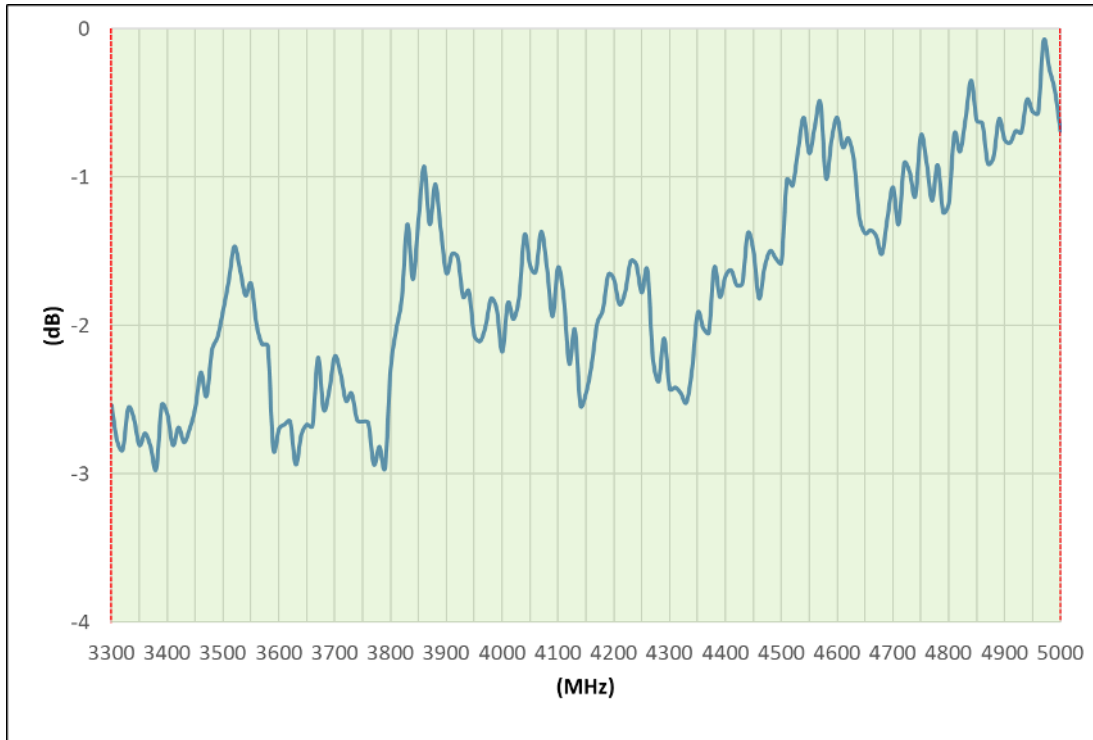

© Unictron Technologies Corp.
All specifications subject to change without notice.

d) Peak Gain (dBi)

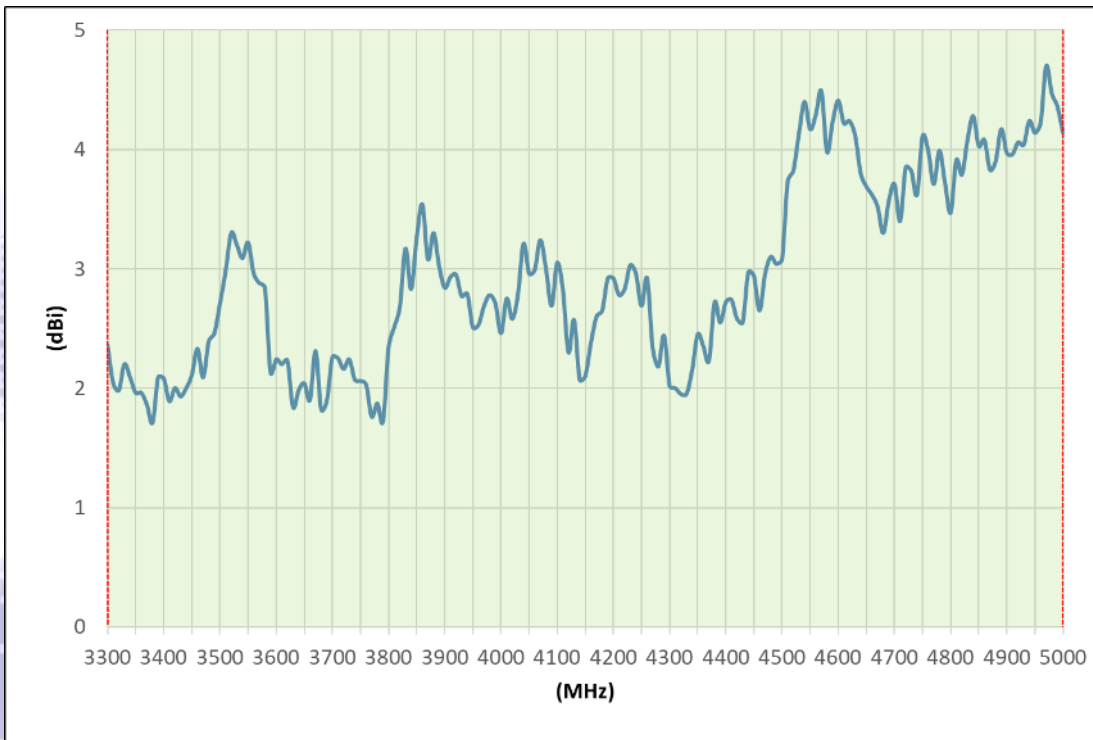

V. Antenna Radiation Pattern Measurement:

The antenna radiation patterns are measured in Unictron's 3D Anechoic Chamber. The measurement setup is as show below.

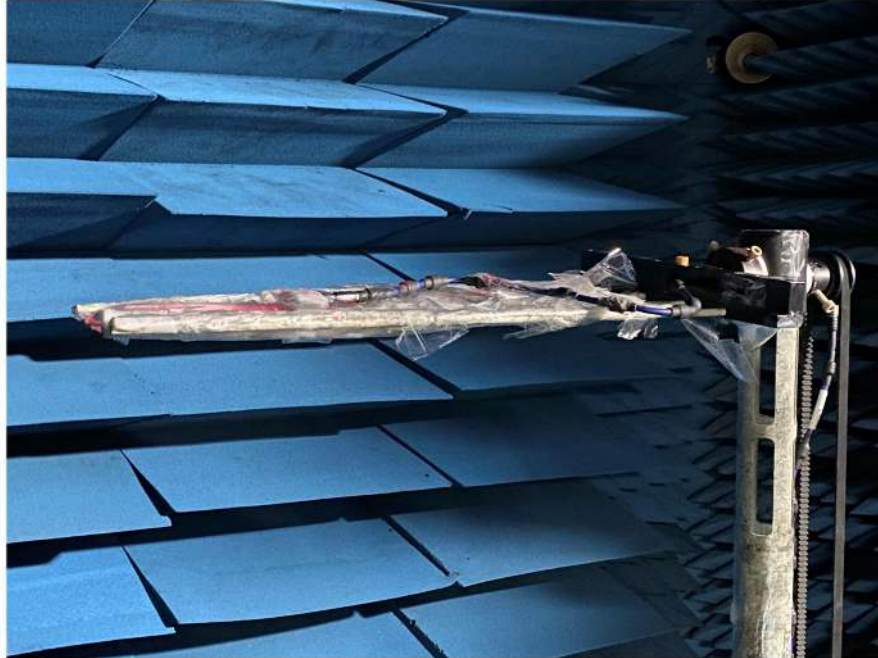

© Unictron Technologies Corp.
All specifications subject to change without notice.

2D Radiation Gain Pattern

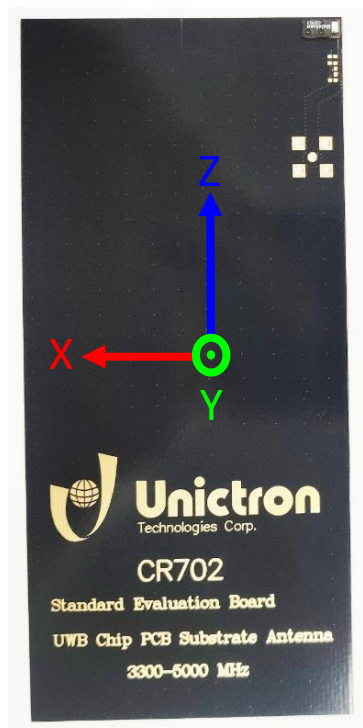

2D Radiation Gain Pattern @ 4150 MHz (Unit: dBi)

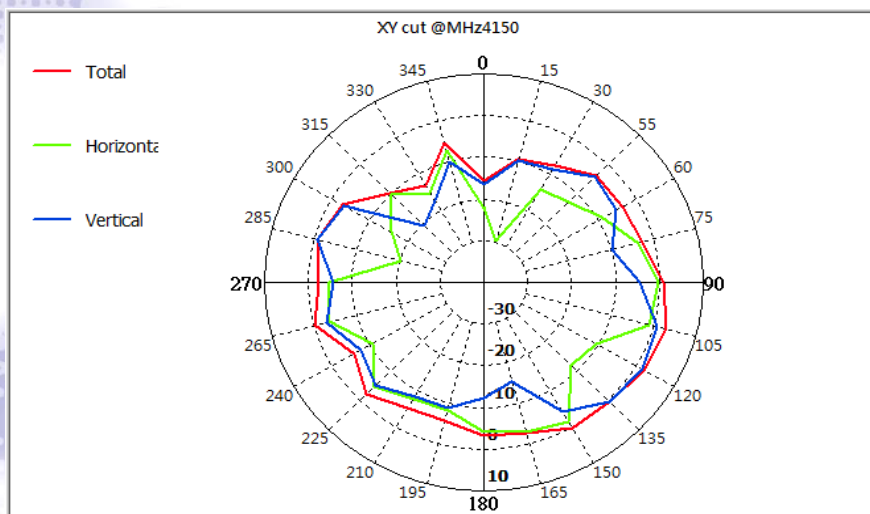
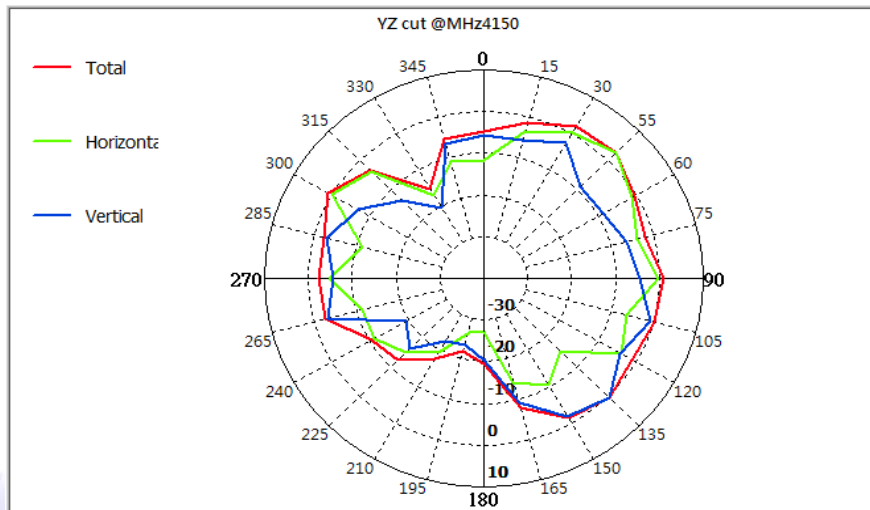
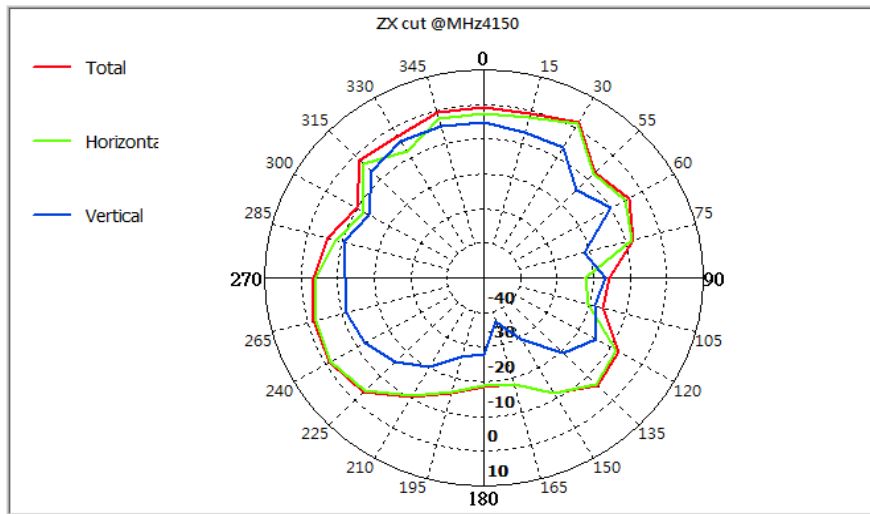

© Unictron Technologies Corp.
All specifications subject to change without notice.

VI. Frequency tuning:

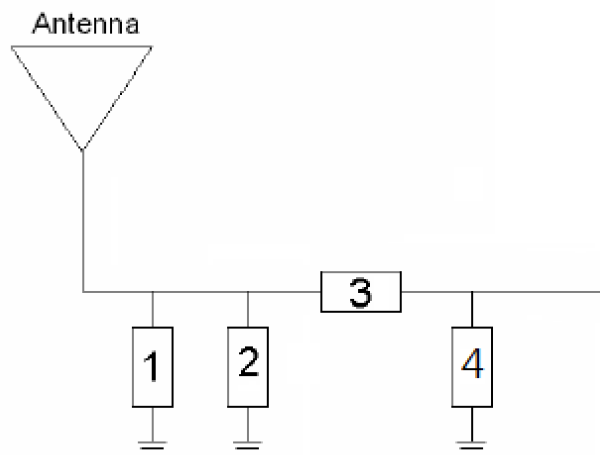
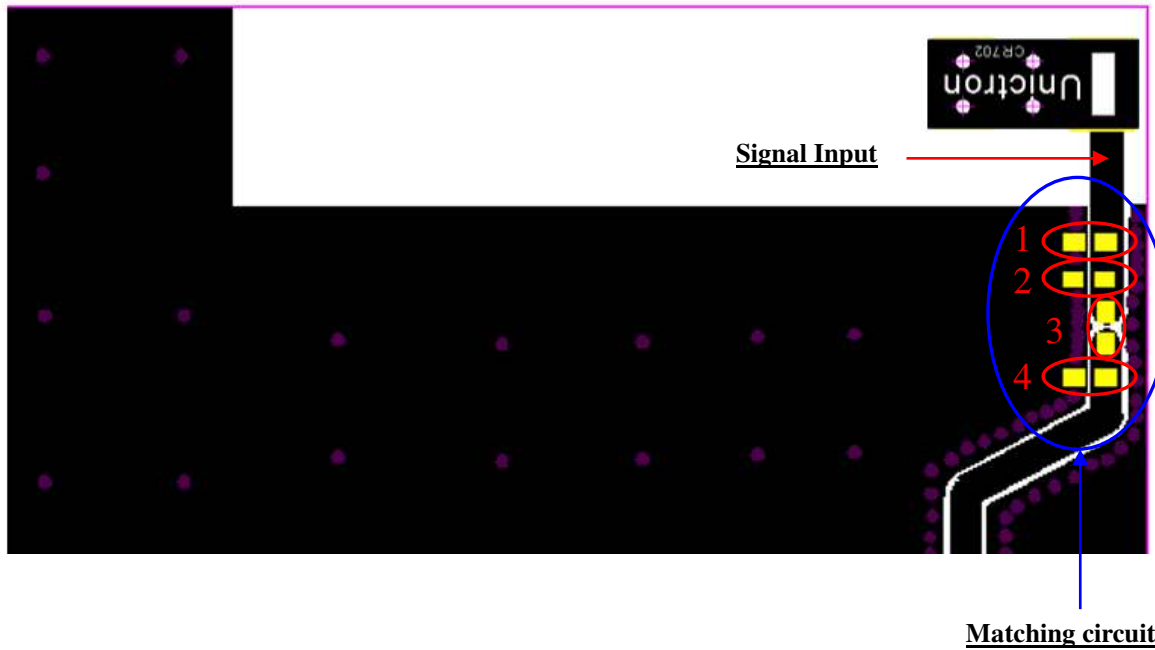

System Matching Circuit Component			
Location	Description	Vendor	Tolerance
1	4.3nH, (0402)	MURATA	±0.1nH
2	NA	-	-
3	0Ω	-	-
4	NA	-	-

VII. Soldering conditions:

Typical Soldering Profile for Lead-free Process

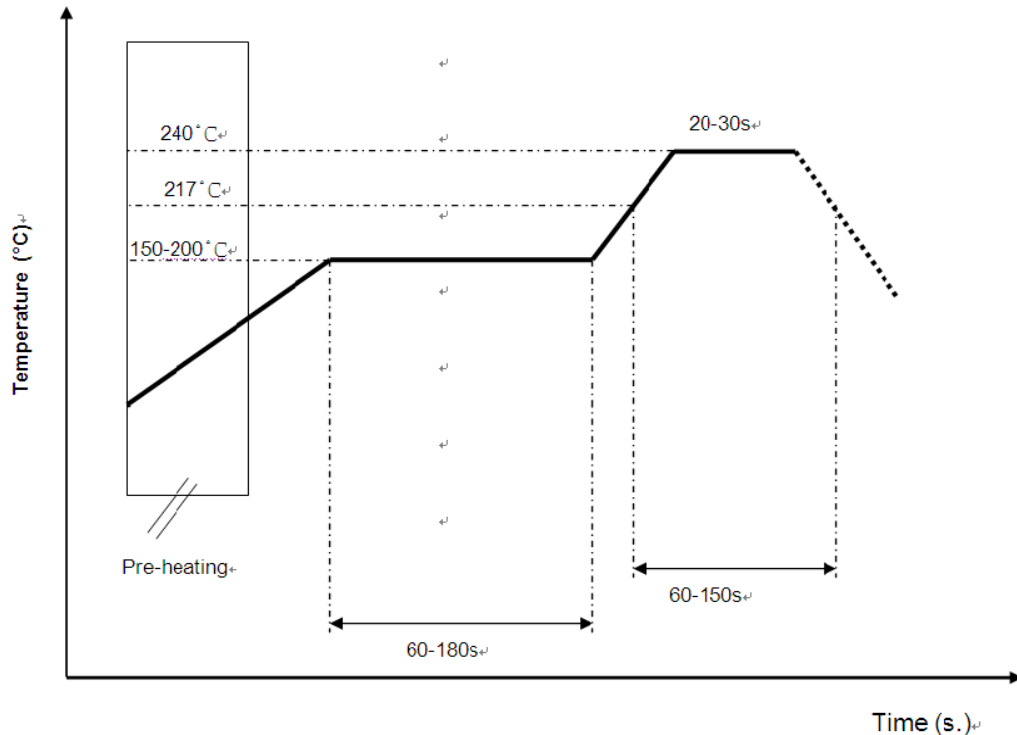

© Unictron Technologies Corp.
All specifications subject to change without notice.

*Recommended solder paste alloy: SAC305 (Sn96.5 /Ag3 /Cu0.5) Lead Free solder paste.

VIII. Reminders for use of Unictron's ceramic chip antennas:

- a) This chip antenna is made of ceramic materials which is relatively more rigid and brittle compared to circuit board materials. Furthermore, the length of this antenna is quite long. Bending of circuit board at the locations where chip antenna is mounted may cause the cracking of solder joints or antenna itself.
- b) Punching/cutting of the break-off tab of PCB panel may cause severe bending of the circuit board which may result in cracking of solder joints or chip antenna itself. Therefore break-off tab shall be located away from the installation site of chip antenna.
- c) Be cautious when ultrasonic welding process needs to be used near the locations where chip antennas are installed. Strong ultrasonic vibration may cause the cracking of chip antenna solder joints.

IX. Operating & Storage conditions:

a) Operating

- (1) Maximum Input Power: 2 W
- (2) Operating Temperature: -40°C to 85°C
- (3) Relative Humidity: 10% to 70%

b) Storage (sealed)

- (1) Storage Temperature: -5°C to 40°C
- (2) Relative Humidity: 20% to 70%
- (3) Shelf Life: 1 year

c) Storage (After mounted on customer's PCB with SMT process)

- (1) Storage Temperature: -40°C to 85°C
- (2) Relative Humidity: 10% to 70%

X. Notice

(1) Installation Guide:

Please refer to Unictron's application note "General guidelines for the installation of Unictron's chip antennas" for further information.

(2) All specifications are subject to change without notice.

XI. Packing

- (1) Unit Weight: $0.03 \pm 0.005(g)$
- (2) Quantity/Reel: 3000 pcs/Reel
- (3) Plastic tape: Black Conductive Polystyrene

a. Tape Drawing (unit: mm)

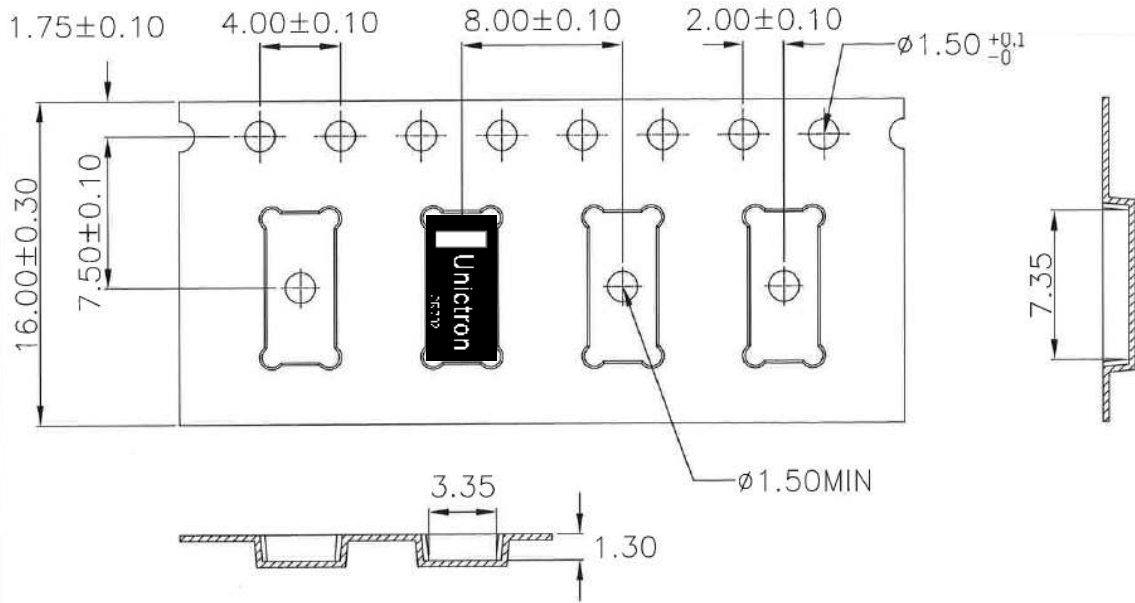

b. Reel Drawing (unit: mm)

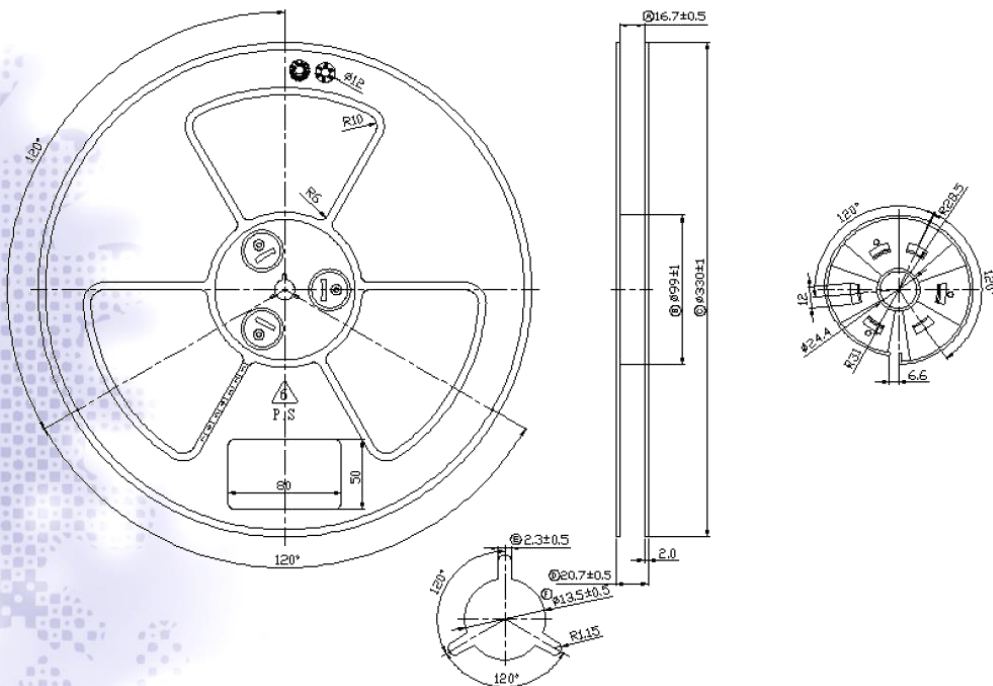

© Unictron Technologies Corp.
All specifications subject to change without notice.