



IR Emitter and Detector Product Data Sheet

LTR-546AB

Spec No.: DS-50-98-0010

Effective Date: 05/18/2010

Revision: B

LITE-ON DCC

RELEASE

BNS-OD-FC001/A4

FEATURES

- * HIGH PHOTO SENSITIVITY
- * SUITABLE FOR INFRARED RADIATION
- * LOW JUNCTION CAPACITANCE
- * HIGH CUT-OFF FREQUENCY
- * FAST SWITCHING TIME
- * THE LTR-546AB IS A SPECIAL DARK BLUE PLASTIC PACKAGE THAT CUT THE VISIBLE LIGHT AND SUITABLE FOR THE DETECTORS OF INFRARED APPLICATIONS

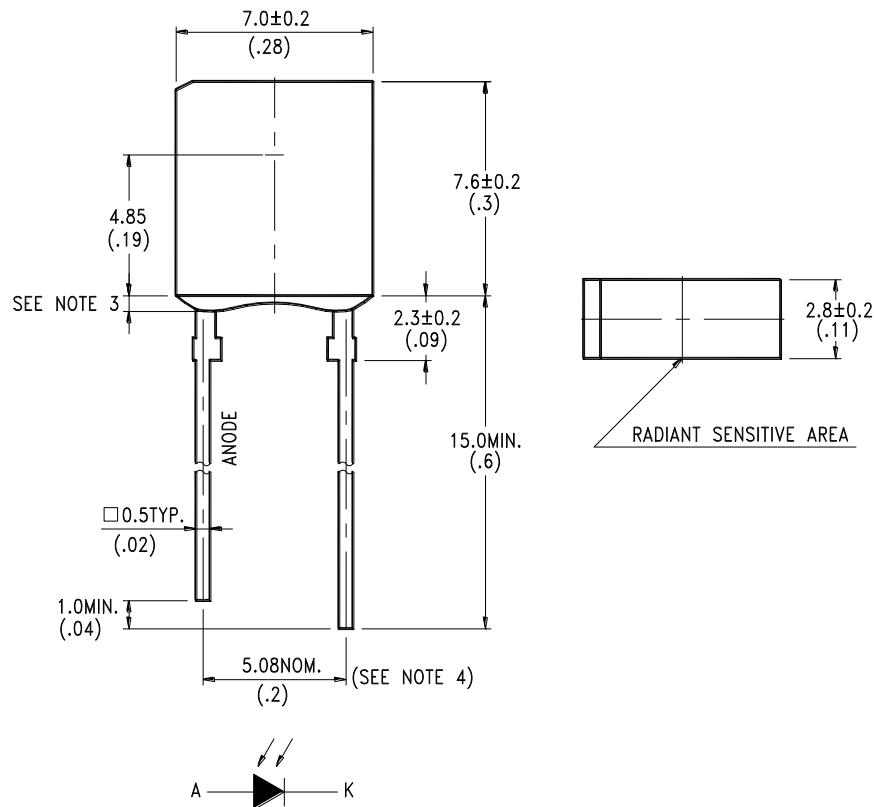
PACKAGE DIMENSIONS**NOTES:**

1. All dimensions are in millimeters (inches).
2. Tolerance is ± 0.25 mm(.010") unless otherwise noted.
3. Protruded resin under flange is 1.5mm(.059") max.
4. Lead spacing is measured where the leads emerge from the package.
5. Specifications are subject to change without notice.



LITE-ON TECHNOLOGY CORPORATION.

Property of Lite-On Only

ABSOLUTE MAXIMUM RATINGS AT TA=25°C

PARAMETER	MAXIMUM RATING	UNIT
Power Dissipation	150	mW
Reverse Voltage	30	V
Operating Temperature Range	-40°C to + 85°C	
Storage Temperature Range	-55°C to + 100°C	
Lead Soldering Temperature [1.6mm(.063") From Body]	260°C for 5 Seconds	

ELECTRICAL OPTICAL CHARACTERISTICS AT TA=25°C

PARAMETER	SYMBOL	MIN.	TYP.	MAX.	UNIT	TEST CONDITION
Reverse Break Down Voltage	V _{(BR)R}	30			V	I _R = 100 μ A E _e = 0mW/cm ²
Reverse Dark Current Voltage	I _{D(R)}			30	nA	V _R = 10V E _e = 0mW/cm ²
Open Circuit Voltage	V _{OC}		350		mV	λ = 940nm E _e = 0.5mW/cm ²
Rise Time	T _r		50		nsec	V _R = 10V λ = 940nm R _L = 1K Ω
Fall Time	T _f		50		nsec	
Short Circuit Current	I _S	1.7	2		μ A	V _R = 5V λ = 940nm E _e = 0.1mW/cm ²
Total Capacitance	C _T		25		pF	V _R = 3V f = 1MHz E _e = 0mW/cm ²
Wavelength of the Max Sensitivity	λ S _{MAX}		900		nm	

TYPICAL ELECTRICAL / OPTICAL CHARACTERISTICS CURVES

(25°C Ambient Temperature Unless Otherwise Noted)

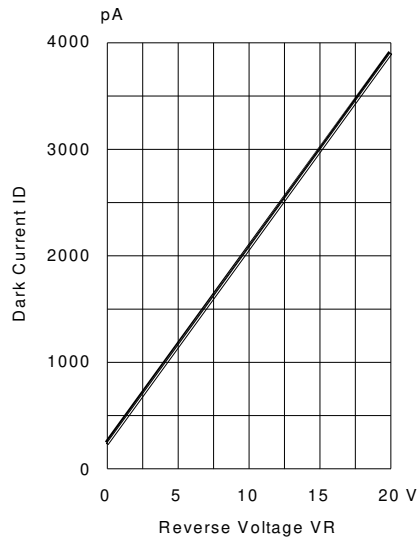

Fig.1 DARK CURRENT VS. REVERSE VOLTAGE
TA=25° C, Ee=0 mW/cm²

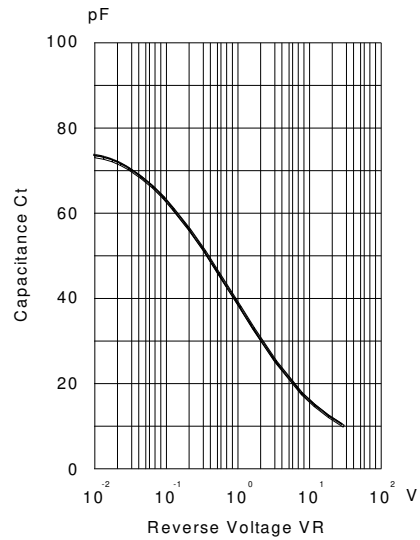

Fig.2 CAPACITANCE VS. REVERSE VOLTAGE
F=1MHZ; Ee=0mW/cm²

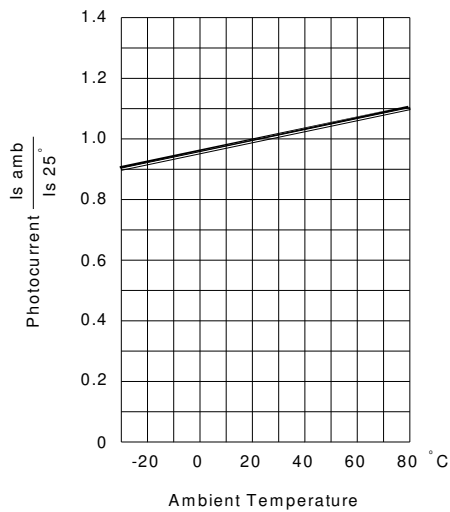

Fig.3 PHOTOCURRENT VS. AMBIENT TEMPERATURE

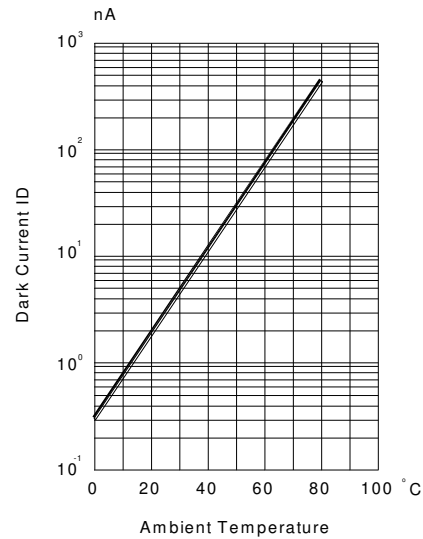

Fig.4 DARK CURRENT AMBIENT TEMPERATURE
VR=10, Ee=0mW/cm²

TYPICAL ELECTRICAL / OPTICAL CHARACTERISTICS CURVES

(25°C Ambient Temperature Unless Otherwise Noted)

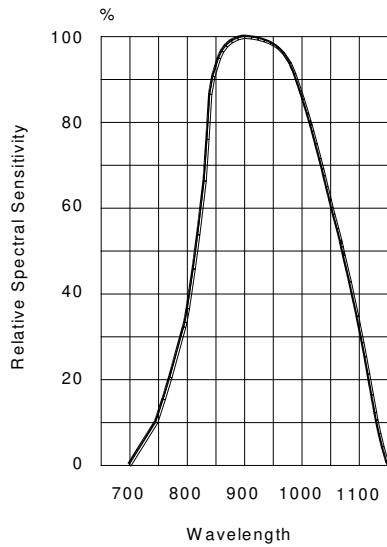

Fig.5 RELATIVE SPECTRAL SENSITIVITY VS WAVELENGTH

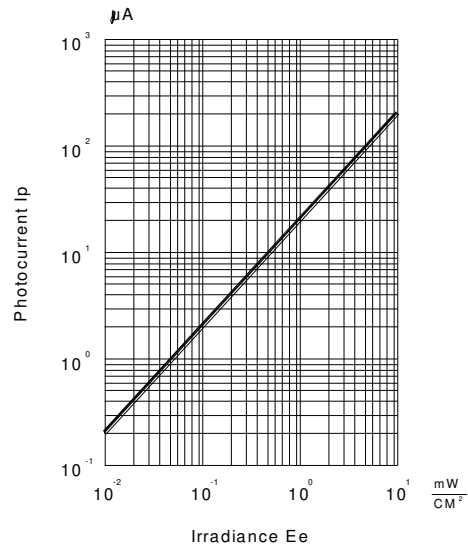

Fig.6 PHOTOCURRENT VS IRRADIANCE $\lambda= 940$ nm

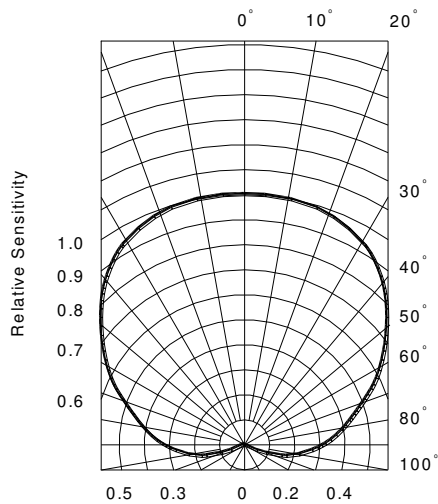

Fig.7 SENSITIVITY DIAGRAM

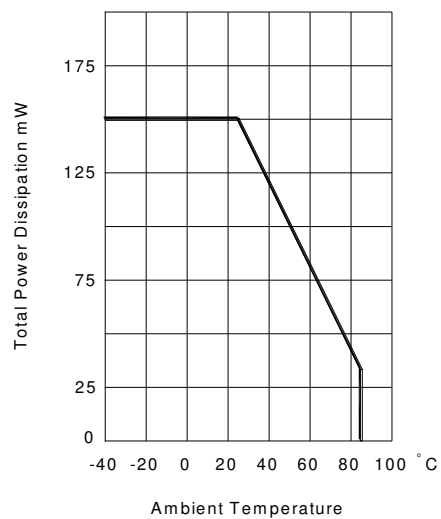

Fig.8 TOTAL POWER DISSIPATION VS AMBIENT TEMPERATURE