

<b>GlobTek, Inc.</b> www.globtek.com 186 Veterans Drive, Northvale, NJ 07647 Tel. (201) 784-1000 Fax (201) 784-0111	Drawing Title: GTM96180-1830-12.0-T3, ICT / ITE / Medical Power Supply/Class 2/Household Power Supply, Efficiency Level: USA DOE Level VI / Eco-design Directive 2009/125/EC, (EU) 2019/1782, Case Color/Style: GlobTek Black, Desktop/External, Regulated Switchmode AC-DC Power Supply AC Adaptor, Input Rating: 100-240V~, 50-60 Hz, IEC 60320/C14 , Output Rating: 18W, 18.0V@1.0A, Output Configuration: 1500 mm, 18/1C + Shield Cond, UL 1185, Female Barrel 5.5 * 2.5 * 11mm with internal Spring Clip and Locking Notch or Equal, Ferrite: None, GlobTek Black, GT Cord # C5101, Pin Out: Center Positive (+V), symbol compliant with IEC 60417 symbol no. 5926, Blades/Input Cord: (Order Separately), Approvals: IRAM; IP42; CB 62368; CB 60950; Class I; 230V CoC Tier 2; cULus (9V only); Korea (9, 12V Only); EAC; UKCA; LPS 62368; NrCAN (9V only); UL 1310; ETL 62368; Conforms to 62368-1; Morocco; NOM (9V only); S-Mark 62368; India BIS 5, 5.95, 7.5, 9, 12, 15, 19, 24, 48V; RCM; Korea (5, 5.2, 5.95 & 7.5V Only); S-Mark 60950; ETL; CCC; CE; IRAM; CB 60335; cETLus UL1310; Fuse 60335; Fuse 60335; CE; China RoHS; Level VI; LPS 60950; RoHS; Ukraine; VCCI; WEEE; PSE; PSE; FCC; CAN ICES-3; cETLus; cETLus 60601-1 3rd; CB 60601-1;	
	Model No. GTM96180-1830-12.0-T3	
	Part No./Ordering No. TR9CH1000LCP-IM-R6B	Rev B

In Addition to GlobTek Inc.'s renewed ISO9001:2015 - Quality Management System Certification, GlobTek Inc. is now certified to:

ISO13485:2016 - Medical Devices Quality Management System Certification

ISO14001:2015 - Environmental Management System Certification

ISO Certificates are available online at <https://www.globtek.com/iso-certificates/>

The acceptance of this specification and use of the product described in this document indicates the acceptance and binding of the customer to Globtek TERMS AND CONDITIONS (attached to the end of this document), which supersede all other agreements, terms, and conditions (<https://en.globtek.com/terms-and-conditions/>).

The purchaser of this product (Customer) agrees that it is their sole responsibility to determine suitability/fitness of the product described in this specification for their application and to take precautions for protection against any hazards attendant to the handling and use of the product.

Footnote:

GlobTek Inc. will not be liable for the safety and performance of these power supplies/battery packs if unauthorized access and repair occurs. End user should consult applicable UL, CSA or EN standards for proper installation instruction.

Limitation of Use:

GlobTek products are intended for use with commercial, medical, and/or industrial equipment only. GlobTek product are not authorized for use as mission critical components in life support hazardous environment, nuclear or aircraft applications without prior written approval from the CEO of GlobTek Inc.

Contents of this document are subject to change without prior notice.

### Customer Approval of Specification:

Please approve, sign and send back to GlobTek so we can complete order processing.

A delay in receipt of this form will delay delivery schedule.

Company Name: _____	Customer P/N: _____
Quote Number: _____	Date: _____
Authorized Representative Name: _____	Authorized Representative Signature: _____

<b>GlobTek, Inc.</b> www.globtek.com 186 Veterans Drive, Northvale, NJ 07647 Tel. (201) 784-1000 Fax (201) 784-0111	Drawing Title: GTM96180-1830-12.0-T3, ICT / ITE / Medical Power Supply/Class 2/Household Power Supply, Efficiency Level: USA DOE Level VI / Eco-design Directive 2009/125/EC, (EU) 2019/1782, Case Color/Style: GlobTek Black, Desktop/External, Regulated Switchmode AC-DC Power Supply AC Adaptor, Input Rating: 100-240V~, 50-60 Hz, IEC 60320/C14 , Output Rating: 18W, 18.0V@1.0A, Output Configuration: 1500 mm, 18/1C + Shield Cond, UL 1185, Female Barrel 5.5 * 2.5 * 11mm with internal Spring Clip and Locking Notch or Equal, Ferrite: None, GlobTek Black, GT Cord # C5101, Pin Out: Center Positive (+V), symbol compliant with IEC 60417 symbol no. 5926, Blades/Input Cord: (Order Separately), Approvals: IRAM; IP42; CB 62368; CB 60950; Class I; 230V CoC Tier 2; cULus (9V only); Korea (9, 12V Only); EAC; UKCA; LPS 62368; NrCAN (9V only); UL 1310; ETL 62368; Conforms to 62368-1; Morocco; NOM (9V only); S-Mark 62368; India BIS 5, 5.95, 7.5, 9, 12, 15, 19, 24, 48V; RCM; Korea (5, 5.2, 5.95 & 7.5V Only); S-Mark 60950; ETL; CCC; CE; IRAM; CB 60335; cETLus UL1310; Fuse 60335; Fuse 60335; CE; China RoHS; Level VI; LPS 60950; RoHS; Ukraine; VCCI; WEEE; PSE; PSE; FCC; CAN ICES-3; cETLus; cETLus 60601-1 3rd; CB 60601-1;	
	Model No. GTM96180-1830-12.0-T3	
	Part No./Ordering No. TR9CH1000LCP-IM-R6B	Rev B

## REVISION HISTORY

REV	DESCRIPTION	SUB	DATE	APPROVED
B	Updated plug from 5.5 * 2.1 to 5.5 * 2.5	fclif	10/30/2018	QA
A	Initial Release	bsiep	02/23/2017	QA

### POWER SUPPLY INFORMATION

TYPE	Desktop/External
TECHNOLOGY	Regulated Switchmode AC-DC Power Supply AC Adaptor
CASE COLOR	GlobTek Black
NAMEPLATE RATED INPUT	100-240V~, 50-60 Hz, 0.6 A
INPUT CONFIG	IEC 60320/C14
WATTS	18.00
VOLTS OUT	18.0
CURRENT OUT (Amps)	1.0
BLADE/CORD INCLUDED	None (Order Separately)
BLADE/CORD INSTALLED	None :(Order Separately)
INGRESS PROTECTION	IP42
GROUNDING CONFIGURATION	(E1) Earthed output
EFFICIENCY LEVEL	<a href="#">USA DOE Level VI</a> / <a href="#">Eco-design Directive 2009/125/EC, (EU) 2019/1782</a> - <a href="#">Europe Code of Conduct on Energy Efficiency of External Power Supplies - Version 5</a>
OUTPUT CONFIGURATION	1500 mm, 18/1C + Shield Cond, UL 1185, Female Barrel 5.5 * 2.5 * 11mm with internal Spring Clip and Locking Notch or Equal, Ferrite: None, GlobTek Black, GT Cord # C5101
OVERMOLDED	Yes
CONNECTOR PIN OUT	Center Positive (+V), symbol compliant with IEC 60417 symbol no. 5926
LABEL SPECS	Standard GT,L-1186
SPECIAL BARCODE LABEL MATERIAL	No
PACK SPEC	Standard DT, Individually Box, GT User Manual
USER MANUAL	809-DESKTOPUSERMANUAL on A4 paper

**PROPRIETARY INFORMATION**

PROPRIETARY OF GLOBTEK, INC. ANY REPRODUCTION, DISCLOSURE OR USE OF THIS DRAWING, IN WHOLE OR IN PART, IS HEREBY PROHIBITED EXCEPT AS SPECIFIED IN

WRITING BY GLOBTEK, INC. © GlobTek, Inc. 2017 - 2023

quest / 08/03/2023 4:14:55 PM GMT CLONED FROM TR9CH1000LCP-Y-MED(R)

<p>GlobTek, Inc.  www.globtek.com  186 Veterans Drive,  Northvale, NJ 07647  Tel. (201) 784-1000  Fax (201) 784-0111</p>	Drawing Title: GTM96180-1830-12.0-T3, ICT / ITE / Medical Power Supply/Class 2/Household Power Supply, Efficiency Level: USA DOE Level VI / Eco-design Directive 2009/125/EC, (EU) 2019/1782, Case Color/Style: GlobTek Black, Desktop/External, Regulated Switchmode AC-DC Power Supply AC Adaptor, Input Rating: 100-240V~, 50-60 Hz, IEC 60320/C14 , Output Rating: 18W, 18.0V@1.0A, Output Configuration: 1500 mm, 18/1C + Shield Cond, UL 1185, Female Barrel 5.5 * 2.5 * 11mm with internal Spring Clip and Locking Notch or Equal, Ferrite: None, GlobTek Black, GT Cord # C5101, Pin Out: Center Positive (+V), symbol compliant with IEC 60417 symbol no. 5926, Blades/Input Cord: (Order Separately), Approvals: IRAM; IP42; CB 62368; CB 60950; Class I; 230V CoC Tier 2; cULus (9V only); Korea (9, 12V Only); EAC; UKCA; LPS 62368; NrCAN (9V only); UL 1310; ETL 62368; Conforms to 62368-1; Morocco; NOM (9V only); S-Mark 62368; India BIS 5, 5.95, 7.5, 9, 12, 15, 19, 24, 48V; RCM; Korea (5, 5.2, 5.95 & 7.5V Only); S-Mark 60950; ETL; CCC; CE; IRAM; CB 60335; cETLus UL1310; Fuse 60335; Fuse 60335; CE; China RoHS; Level VI; LPS 60950; RoHS; Ukraine; VCCI; WEEE; PSE; PSE; FCC; CAN ICES-3; cETLus; cETLus 60601-1 3rd; CB 60601-1;	
	Model No. GTM96180-1830-12.0-T3	
	Part No./Ordering No. TR9CH1000LCP-IM-R6B	Rev B

Notes/Modifications/Customizations (notes in this section supersede the values shown in the standard spec)  
DIMENSIONS ARE IN MM UNLESS SPECIFIED OTHERWISE

<b>GlobTek, Inc.</b> www.globtek.com 186 Veterans Drive, Northvale, NJ 07647 Tel. (201) 784-1000 Fax (201) 784-0111	Drawing Title: GTM96180-1830-12.0-T3, ICT / ITE / Medical Power Supply/Class 2/Household Power Supply, Efficiency Level: USA DOE Level VI / Eco-design Directive 2009/125/EC, (EU) 2019/1782, Case Color/Style: GlobTek Black, Desktop/External, Regulated Switchmode AC-DC Power Supply AC Adaptor, Input Rating: 100-240V~, 50-60 Hz, IEC 60320/C14 , Output Rating: 18W, 18.0V@1.0A, Output Configuration: 1500 mm, 18/1C + Shield Cond, UL 1185, Female Barrel 5.5 * 2.5 * 11mm with internal Spring Clip and Locking Notch or Equal, Ferrite: None, GlobTek Black, GT Cord # C5101, Pin Out: Center Positive (+V), symbol compliant with IEC 60417 symbol no. 5926, Blades/Input Cord: (Order Separately), Approvals: IRAM; IP42; CB 62368; CB 60950; Class I; 230V CoC Tier 2; cULus (9V only); Korea (9, 12V Only); EAC; UKCA; LPS 62368; NrCAN (9V only); UL 1310; ETL 62368; Conforms to 62368-1; Morocco; NOM (9V only); S-Mark 62368; India BIS 5, 5.95, 7.5, 9, 12, 15, 19, 24, 48V; RCM; Korea (5, 5.2, 5.95 & 7.5V Only); S-Mark 60950; ETL; CCC; CE; IRAM; CB 60335; cETLus UL1310; Fuse 60335; Fuse 60335; CE; China RoHS; Level VI; LPS 60950; RoHS; Ukraine; VCCI; WEEE; PSE; PSE; FCC; CAN ICES-3; cETLus; cETLus 60601-1 3rd; CB 60601-1;	
	Model No. GTM96180-1830-12.0-T3	
	Part No./Ordering No. TR9CH1000LCP-IM-R6B	Rev B

## ELECTRICAL SPECIFICATIONS

### Input

Input Voltage:	Specified: 90-264VAC, Nameplate: 100-240VAC 100% rated load current for 90-264VAC 85% rated load current for 85-264VAC 100% rated load current for 110-370VDC
Input Frequency:	Specified: 47-63Hz, Nameplate: 50-60Hz
No Load Input Power:	<75mW @ 230VAC (EU CoC Tier 2 compliant)
Inrush Current:	30A/60A maximum, cold start @ 115VAC/230VAC input, respectively
Efficiency:	DoE Level VI compliant, EU CoC Tier 2 compliant

### Output

Turn-on Delay:	1 second max. @ nominal line and full load
Output Regulation	± 5% max. (measured at the output connector)
Line Regulation:	± 0.5% typ. (measured at the output connector, full load)
Ripple:	1% or 100mV, whichever is greater (measured using a 47µF low-ESR cap + 0.1µF ceramic capacitor, measured @ 20MHz BW, at output connector)
Transient Response:	5% max. deviation (with 40-70% load step), 1ms typ. recovery time
Hold-up Time:	8ms typ. @ nominal line and full load
Power On Indicator:	Green LED

### Protections

Input Protection:	MOV transient suppressor, input line fusing
Over-Voltage Protection:	110-130% of nominal output voltage
Short-Circuit Protection:	Auto-restart
Over-Current Protection:	110-160% of rated output current (Current limit range is determined by normal output power rating, not derated power level)

### Environmental

MTBF:	1,500,000 hours @ 25°C ambient, full load (Telcordia SR-332, Issue 3)
Operating Temperature:	-20°C to 40°C (full load) See derating table for output power capability at other temperatures. Extended low temperature range available as a custom option.
Storage Temperature:	-30°C to 80°C
Humidity:	0% to 95% relative humidity, non-condensing
Altitude:	5000m

#### PROPRIETARY INFORMATION

PROPRIETARY OF GLOBTEK, INC. ANY REPRODUCTION, DISCLOSURE OR USE OF THIS DRAWING, IN WHOLE OR IN PART, IS HEREBY PROHIBITED EXCEPT AS SPECIFIED IN WRITING BY GLOBTEK, INC. © GlobTek, Inc. 2017 - 2023

<b>GlobTek, Inc.</b> www.globtek.com 186 Veterans Drive, Northvale, NJ 07647 Tel. (201) 784-1000 Fax (201) 784-0111	Drawing Title: GTM96180-1830-12.0-T3, ICT / ITE / Medical Power Supply/Class 2/Household Power Supply, Efficiency Level: USA DOE Level VI / Eco-design Directive 2009/125/EC, (EU) 2019/1782, Case Color/Style: GlobTek Black, Desktop/External, Regulated Switchmode AC-DC Power Supply AC Adaptor, Input Rating: 100-240V~, 50-60 Hz, IEC 60320/C14 , Output Rating: 18W, 18.0V@1.0A, Output Configuration: 1500 mm, 18/1C + Shield Cond, UL 1185, Female Barrel 5.5 * 2.5 * 11mm with internal Spring Clip and Locking Notch or Equal, Ferrite: None, GlobTek Black, GT Cord # C5101, Pin Out: Center Positive (+V), symbol compliant with IEC 60417 symbol no. 5926, Blades/Input Cord: (Order Separately), Approvals: IRAM; IP42; CB 62368; CB 60950; Class I; 230V CoC Tier 2; cULus (9V only); Korea (9, 12V Only); EAC; UKCA; LPS 62368; NrCAN (9V only); UL 1310; ETL 62368; Conforms to 62368-1; Morocco; NOM (9V only); S-Mark 62368; India BIS 5, 5.95, 7.5, 9, 12, 15, 19, 24, 48V; RCM; Korea (5, 5.2, 5.95 & 7.5V Only); S-Mark 60950; ETL; CCC; CE; IRAM; CB 60335; cETLus UL1310; Fuse 60335; Fuse 60335; CE; China RoHS; Level VI; LPS 60950; RoHS; Ukraine; VCCI; WEEE; PSE; PSE; FCC; CAN ICES-3; cETLus; cETLus 60601-1 3rd; CB 60601-1;	
	Model No. GTM96180-1830-12.0-T3	
	Part No./Ordering No. TR9CH1000LCP-IM-R6B	Rev B

Ingress protection:	IP42 standard, IP52 available as a special option
Cooling:	Convection
RoHS:	Complies with EU 2011/65/EU amended by EU 2015/863 and China SJ/T 11363-2006

## Safety

Dielectric Withstand Voltage:	4000VAC or 5656VDC from input to output 3000VAC or 4242VDC from input to earth (Class I models)
Touch Current:	Class I models: < 20uA Class II models: <75uA
Earth Leakage Current:	Class I models: <300uA Class II models: N/A
Isolation Options:	Floating output or Class I earthed output (desktop models)
Earth Continuity Test:	< 0.1 ohm between AC inlet earth pin and PCB termination point
Means of Protection (Primary-to-Secondary):	2 x MOPP
Compliant Standards:	See listing at the end of this document.

## EMC

Applicable Standards:	Medical: EN60601-1-2, 4th edition Emissions: EN55032, EN61000-6-3, EN61000-6-4 Immunity: EN55024, EN61000-6-1, EN61000-6-2
Conducted Emissions:	Class B, FCC Part 15, Class B (with resistive load)
Radiated Emissions:	Class B, FCC Part 15, Class B (with resistive load)
Harmonic Current Voltage Distortion:	EN61000-3-2, Class A
Voltage Fluctuations/Flicker:	EN61000-3-3
Electrostatic Discharge (ESD) Immunity:	EN61000-4-2, 8KV contact discharge, 20KV air discharge
Radiated RF Immunity:	EN61000-4-3, 10V/m 80-1000MHz, 3V/m 1-2.7GHz, 80% 1KHz AM
EFT/Burst Immunity:	EN61000-4-4, 4KV/100kHz.
Line Surge Immunity:	EN61000-4-5, 2KV differential, 4KV common-mode
Conducted RF Immunity:	EN61000-4-6, 3VRMS, 80% 1KHz AM
Power Frequency Magnetic Field Immunity:	EN61000-4-8, 30A/m
Voltage Dip Immunity:	EN61000-4-11

## Enclosure

Housing:	High impact plastic, 94V0 polycarbonate, non-vented
AC Input Mechanical Options:	Wall plug-in, changeable blades (Class II only) Desktop housing, extended housing: C6, C8, C14, or C18 IEC inlet (Class I or Class II)
Markings:	Label or laser printed

<p>GlobTek, Inc. www.globtek.com 186 Veterans Drive, Northvale, NJ 07647 Tel. (201) 784-1000 Fax (201) 784-0111</p>	<p>Drawing Title: GTM96180-1830-12.0-T3, ICT / ITE / Medical Power Supply/Class 2/Household Power Supply, Efficiency Level: USA DOE Level VI / Eco-design Directive 2009/125/EC, (EU) 2019/1782, Case Color/Style: GlobTek Black, Desktop/External, Regulated Switchmode AC-DC Power Supply AC Adaptor, Input Rating: 100-240V~, 50-60 Hz, IEC 60320/C14 , Output Rating: 18W, 18.0V@1.0A, Output Configuration: 1500 mm, 18/1C + Shield Cond, UL 1185, Female Barrel 5.5 * 2.5 * 11mm with internal Spring Clip and Locking Notch or Equal, Ferrite: None, GlobTek Black, GT Cord # C5101, Pin Out: Center Positive (+V), symbol compliant with IEC 60417 symbol no. 5926, Blades/Input Cord: (Order Separately), Approvals: IRAM; IP42; CB 62368; CB 60950; Class I; 230V CoC Tier 2; cULus (9V only); Korea (9, 12V Only); EAC; UKCA; LPS 62368; NrCAN (9V only); UL 1310; ETL 62368; Conforms to 62368-1; Morocco; NOM (9V only); S-Mark 62368; India BIS 5, 5.95, 7.5, 9, 12, 15, 19, 24, 48V; RCM; Korea (5, 5.2, 5.95 &amp; 7.5V Only); S-Mark 60950; ETL; CCC; CE; IRAM; CB 60335; cETLus UL1310; Fuse 60335; Fuse 60335; CE; China RoHS; Level VI; LPS 60950; RoHS; Ukraine; VCCI; WEEE; PSE; PSE; FCC; CAN ICES-3; cETLus; cETLus 60601-1 3rd; CB 60601-1;</p>	
	<p>Model No. GTM96180-1830-12.0-T3</p>	
	<p>Part No./Ordering No. TR9CH1000LCP-IM-R6B</p>	<p>Rev B</p>

## Special Options

1. Removal of LED (optional)
2. Custom cord-sets (custom cord and/or connector types). Note: 5VDC USB power supplies with Micro-B or Type-C connectors have a voltage regulation specification of  $\pm 8\%$  (4.6V to 5.4V).
3. Custom markings
4. Short term output surge capability
5. Reduced leakage current versions (10uA max) for Type-CF medical applications and/or for AC noise sensitive equipment. (15W or less, 5 to 24V output voltage range.)
6. Tightened output voltage tolerance
7. Reduced output voltage ripple
8. Improved reliability PCB laminate with plated-through-holes for IPC610 Class 2 compliance
9. Custom housing colors
10. Quasi constant-current output for SLA (lead-acid) battery charging applications

TO ADDRESS SYSTEM-LEVEL EMI CONCERNS, FERRITE CHOKES/BEADS MAY BE ADDED/REVISED UPON REQUEST. A SAMPLE KIT OF GLOBTEK'S STANDARD FERRITES IS AVAILABLE UNDER GLOBTEK P/N: EMI-MITIGATION-KIT1

FOR ADDITIONAL INFORMATION, PLEASE READ OUR WHITE PAPER AT: <https://r.globtek.info/3QeaqtD>

INGRESS PROTECTION: IP42

GlobTek, Inc.  
 www.globtek.com  
 186 Veterans Drive,  
 Northvale, NJ 07647  
 Tel. (201) 784-1000  
 Fax (201) 784-0111

Drawing Title: GTM96180-1830-12.0-T3, ICT / ITE / Medical Power Supply/Class 2/Household Power Supply, Efficiency Level: USA DOE Level VI / Eco-design Directive 2009/125/EC, (EU) 2019/1782, Case Color/Style: GlobTek Black, Desktop/External, Regulated Switchmode AC-DC Power Supply AC Adaptor, Input Rating: 100-240V~, 50-60 Hz, IEC 60320/C14 , Output Rating: 18W, 18.0V@1.0A, Output Configuration: 1500 mm, 18/1C + Shield Cond, UL 1185, Female Barrel 5.5 \* 2.5 \* 11mm with internal Spring Clip and Locking Notch or Equal, Ferrite: None, GlobTek Black, GT Cord # C5101, Pin Out: Center Positive (+V), symbol compliant with IEC 60417 symbol no. 5926, Blades/Input Cord: (Order Separately), Approvals: IRAM; IP42; CB 62368; CB 60950; Class I; 230V CoC Tier 2; cULus (9V only); Korea (9, 12V Only); EAC; UKCA; LPS 62368; NrCAN (9V only); UL 1310; ETL 62368; Conforms to 62368-1; Morocco; NOM (9V only); S-Mark 62368; India BIS 5, 5.95, 7.5, 9, 12, 15, 19, 24, 48V; RCM; Korea (5, 5.2, 5.95 & 7.5V Only); S-Mark 60950; ETL; CCC; CE; IRAM; CB 60335; cETLus UL1310; Fuse 60335; Fuse 60335; CE; China RoHS; Level VI; LPS 60950; RoHS; Ukraine; VCCI; WEEE; PSE; PSE; FCC; CAN ICES-3; cETLus; cETLus 60601-1 3rd; CB 60601-1;

Model No. GTM96180-1830-12.0-T3

Part No./Ordering No. TR9CH1000LCP-IM-R6B

Rev B

3D File Download <https://www.globtek.com/dl/GTM96180-T3.igs>

Mechanical drawing

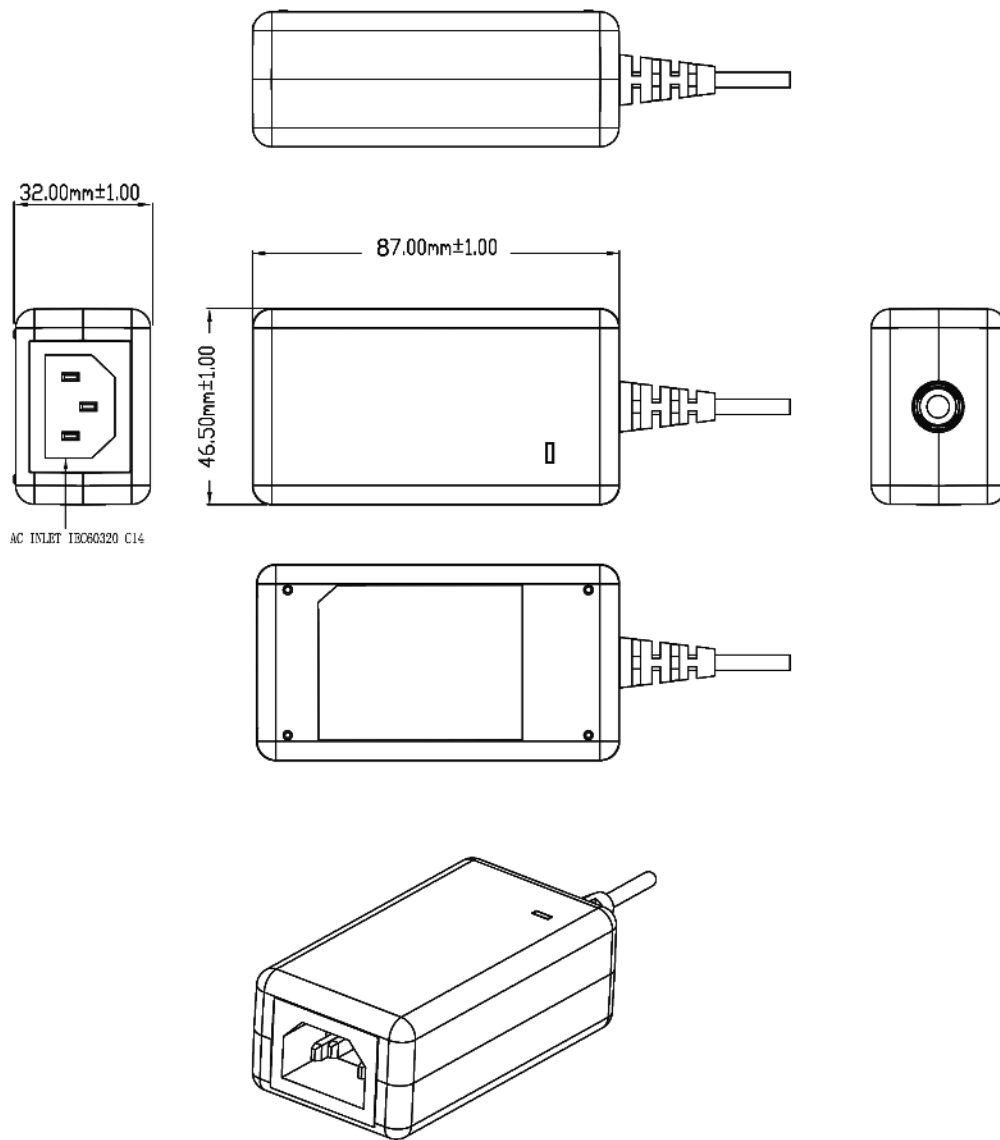

GlobTek, Inc.  
 www.globtek.com  
 186 Veterans Drive,  
 Northvale, NJ 07647  
 Tel. (201) 784-1000  
 Fax (201) 784-0111

Drawing Title: GTM96180-1830-12.0-T3, ICT / ITE / Medical Power Supply/Class 2/Household Power Supply, Efficiency Level: USA DOE Level VI / Eco-design Directive 2009/125/EC, (EU) 2019/1782, Case Color/Style: GlobTek Black, Desktop/External, Regulated Switchmode AC-DC Power Supply AC Adaptor, Input Rating: 100-240V~, 50-60 Hz, IEC 60320/C14 , Output Rating: 18W, 18.0V@1.0A, Output Configuration: 1500 mm, 18/1C + Shield Cond, UL 1185, Female Barrel 5.5 \* 2.5 \* 11mm with internal Spring Clip and Locking Notch or Equal, Ferrite: None, GlobTek Black, GT Cord # C5101, Pin Out: Center Positive (+V), symbol compliant with IEC 60417 symbol no. 5926, Blades/Input Cord: (Order Separately), Approvals: IRAM; IP42; CB 62368; CB 60950; Class I; 230V CoC Tier 2; cULus (9V only); Korea (9, 12V Only); EAC; UKCA; LPS 62368; NrCAN (9V only); UL 1310; ETL 62368; Conforms to 62368-1; Morocco; NOM (9V only); S-Mark 62368; India BIS 5, 5.95, 7.5, 9, 12, 15, 19, 24, 48V; RCM; Korea (5, 5.2, 5.95 & 7.5V Only); S-Mark 60950; ETL; CCC; CE; IRAM; CB 60335; cETLus UL1310; Fuse 60335; Fuse 60335; CE; China RoHS; Level VI; LPS 60950; RoHS; Ukraine; VCCI; WEEE; PSE; PSE; FCC; CAN ICES-3; cETLus; cETLus 60601-1 3rd; CB 60601-1;

Model No. GTM96180-1830-12.0-T3

Part No./Ordering No. TR9CH1000LCP-IM-R6B

Rev B

DERATING CURVE

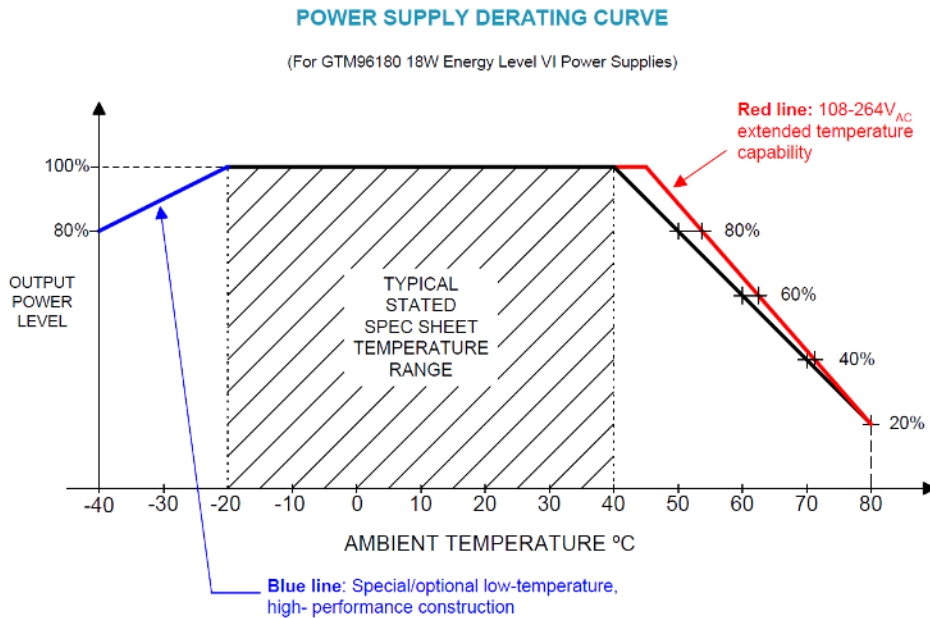



<p>GlobTek, Inc. www.globtek.com 186 Veterans Drive, Northvale, NJ 07647 Tel. (201) 784-1000 Fax (201) 784-0111</p>	<p>Drawing Title: GTM96180-1830-12.0-T3, ICT / ITE / Medical Power Supply/Class 2/Household Power Supply, Efficiency Level: USA DOE Level VI / Eco-design Directive 2009/125/EC, (EU) 2019/1782, Case Color/Style: GlobTek Black, Desktop/External, Regulated Switchmode AC-DC Power Supply AC Adaptor, Input Rating: 100-240V~, 50-60 Hz, IEC 60320/C14 , Output Rating: 18W, 18.0V@1.0A, Output Configuration: 1500 mm, 18/1C + Shield Cond, UL 1185, Female Barrel 5.5 * 2.5 * 11mm with internal Spring Clip and Locking Notch or Equal, Ferrite: None, GlobTek Black, GT Cord # C5101, Pin Out: Center Positive (+V), symbol compliant with IEC 60417 symbol no. 5926, Blades/Input Cord: (Order Separately), Approvals: IRAM; IP42; CB 62368; CB 60950; Class I; 230V CoC Tier 2; cULus (9V only); Korea (9, 12V Only); EAC; UKCA; LPS 62368; NrCAN (9V only); UL 1310; ETL 62368; Conforms to 62368-1; Morocco; NOM (9V only); S-Mark 62368; India BIS 5, 5.95, 7.5, 9, 12, 15, 19, 24, 48V; RCM; Korea (5, 5.2, 5.95 &amp; 7.5V Only); S-Mark 60950; ETL; CCC; CE; IRAM; CB 60335; cETLus UL1310; Fuse 60335; Fuse 60335; CE; China RoHS; Level VI; LPS 60950; RoHS; Ukraine; VCCI; WEEE; PSE; PSE; FCC; CAN ICES-3; cETLus; cETLus 60601-1 3rd; CB 60601-1;</p>	
	<p>Model No. GTM96180-1830-12.0-T3</p>	
	<p>Part No./Ordering No. TR9CH1000LCP-IM-R6B</p>	<p>Rev B</p>

## INPUT CONFIGURATION

(E1) Earthed output

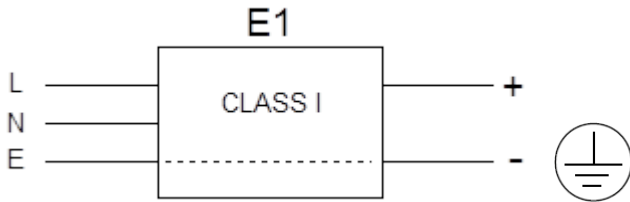

[Alternate grounding configurations](#) available upon request.

Blades/Cord Included:None:(Order Separately)

Blades/Cord Installed:None:(Order Separately)

IEC 60320/C14 AC Inlet Connector, Class I, Earth Ground

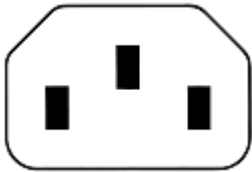

Mates with IEC 60320/C13 Plug

Optional Locking IEC60320 Receptacle and cord option available on some models by request.:



## [Standard International IEC 320/C13 Cordsets](#)

Below are standard cordsets which are "not included" (unless stated above); these can be purchased separately or packaged with the power supply. Contact your Sales Engineer if the style required is not shown below. Many more available in different lengths, colors or cable material.

<b>GlobTek, Inc.</b> www.globtek.com 186 Veterans Drive, Northvale, NJ 07647 Tel. (201) 784-1000 Fax (201) 784-0111	Drawing Title: GTM96180-1830-12.0-T3, ICT / ITE / Medical Power Supply/Class 2/Household Power Supply, Efficiency Level: USA DOE Level VI / Eco-design Directive 2009/125/EC, (EU) 2019/1782, Case Color/Style: GlobTek Black, Desktop/External, Regulated Switchmode AC-DC Power Supply AC Adaptor, Input Rating: 100-240V~, 50-60 Hz, IEC 60320/C14 , Output Rating: 18W, 18.0V@1.0A, Output Configuration: 1500 mm, 18/1C + Shield Cond, UL 1185, Female Barrel 5.5 * 2.5 * 11mm with internal Spring Clip and Locking Notch or Equal, Ferrite: None, GlobTek Black, GT Cord # C5101, Pin Out: Center Positive (+V), symbol compliant with IEC 60417 symbol no. 5926, Blades/Input Cord: (Order Separately), Approvals: IRAM; IP42; CB 62368; CB 60950; Class I; 230V CoC Tier 2; cULus (9V only); Korea (9, 12V Only); EAC; UKCA; LPS 62368; NrCAN (9V only); UL 1310; ETL 62368; Conforms to 62368-1; Morocco; NOM (9V only); S-Mark 62368; India BIS 5, 5.95, 7.5, 9, 12, 15, 19, 24, 48V; RCM; Korea (5, 5.2, 5.95 & 7.5V Only); S-Mark 60950; ETL; CCC; CE; IRAM; CB 60335; cETLus UL1310; Fuse 60335; Fuse 60335; CE; China RoHS; Level VI; LPS 60950; RoHS; Ukraine; VCCI; WEEE; PSE; PSE; FCC; CAN ICES-3; cETLus; cETLus 60601-1 3rd; CB 60601-1;	
	Model No. GTM96180-1830-12.0-T3	
	Part No./Ordering No. TR9CH1000LCP-IM-R6B	Rev B

## Stock Power Supply Cords

Part Number/ Link	Country	Plug	Termination	Length (mm)	(Ft)
<a href="#">3021457F701(R)</a>	N. American (Type B)	NEMA 5-15P	IEC 320/C13	2150	7
<a href="#">1191068F0701(R)</a>	N. American (Type B)	NEMA 5-15P Hospital	IEC 320/C13	2459	8
<a href="#">2194272M5701-T(R)</a>	Argentina (Type I)	IRAM 2073	IEC 320/C13	2500	8
<a href="#">5502022M5701A(R)</a>	Australian (Type I)	AS3112 / 3 PRONG	IEC 320/C13	2500	8
<a href="#">204B4272M5701(R)</a>	Brazil (Type N)	BRAZIL	IEC 320/C13	2500	8
<a href="#">6023602M5701(R)</a>	China (Type I)	CCC GR2099	IEC 320/C13	2500	8
<a href="#">G8014272M5701(R)</a>	Danish (Type K)	AFSNIT SECTION 107-2-D1	IEC 320/C13	2500	8
<a href="#">23144272M5701-T(R)</a>	Europe (Type E)	CEE 7/7	IEC 320/C13	2500	8
<a href="#">23134272M5701EUKR(R)</a>	Europe/Korea Combo (Type E)	CEE 7/7 / KSC8305	IEC 320/C13	2500	8
<a href="#">205IN4272M5701(R)</a>	India (Type D)	India IS 1293 (also known as IA16A3 or BS546)	IEC 320/C13	2500	8
<a href="#">208IN4272M5701(R)</a>	India (Type M)	India IS 1293 (also known as IA16A3 or BS546)	IEC320/C13	2500	8
<a href="#">377C4272M5701(R)</a>	Israel (Type H)	ISL 377C	IEC 320/C13	2500	8
<a href="#">23024272M5701(R)</a>	Italy (Type L)	CEI 23-16/VII	IEC 320/C13	2500	8
3003339F701(R) [3x1.25mm2]	Japan (Type B)	JIS 8303 / 3 PINS	IEC 320/C13	2500	8
3003068F2701-HK(R) [3 x 2.0mm2]					
<a href="#">302J115J6F0701J(R)</a>	North America / Japan (Type B – 12A)	NEMA 5-15P (cULus approved), Japan JIS C 8303 (PSE Approved)	IEC 320/C13	1830	6
<a href="#">302J104J6F0701J(R)</a>	North America / Japan (Type B – 15A)	NEMA 5-15P (cULus approved), Japan JIS C 8303 (PSE Approved)	IEC 320/C13	1830	6
<a href="#">302JT104J9F0701JT(R)</a>	North America / Japan / Taiwan (Type B – 15A)	NEMA 5-15P (cULus approved), Japan JIS C 8303 (PSE Approved), Taiwan CNS 6797 (BSMI Approved)	IEC 320/C13	2800	9
<a href="#">2313K3432M5701(R)</a>	Korea (Type F)	KS C 8305	IEC 320/C13	2500	8
<a href="#">5804272M5701(R)</a>	Russia (Type F)	GOST 7396	IEC 320/C13	2500	8
<a href="#">2084272M5701(R)</a>	South Africa (Type M)	South Africa SABS164-1 (16A type)	IEC 320/C13	2500	8

**PROPRIETARY INFORMATION**

PROPRIETARY OF GLOBTEK, INC. ANY REPRODUCTION, DISCLOSURE OR USE OF THIS DRAWING, IN WHOLE OR IN PART, IS HEREBY PROHIBITED EXCEPT AS SPECIFIED IN Page 10 of 18

WRITING BY GLOBTEK, INC. © GlobTek, Inc. 2017 - 2023

quest / 08/03/2023 4:14:55 PM GMT CLONED FROM TR9CH1000LCP-Y-MED(R)

<b>GlobTek, Inc.</b> <b>www.globtek.com</b> <b>186 Veterans Drive,</b> <b>Northvale, NJ 07647</b> <b>Tel. (201) 784-1000</b> <b>Fax (201) 784-0111</b>	Drawing Title: GTM96180-1830-12.0-T3, ICT / ITE / Medical Power Supply/Class 2/Household Power Supply, Efficiency Level: USA DOE Level VI / Eco-design Directive 2009/125/EC, (EU) 2019/1782, Case Color/Style: GlobTek Black, Desktop/External, Regulated Switchmode AC-DC Power Supply AC Adaptor, Input Rating: 100-240V~, 50-60 Hz, IEC 60320/C14 , Output Rating: 18W, 18.0V@1.0A, Output Configuration: 1500 mm, 18/1C + Shield Cond, UL 1185, Female Barrel 5.5 * 2.5 * 11mm with internal Spring Clip and Locking Notch or Equal, Ferrite: None, GlobTek Black, GT Cord # C5101, Pin Out: Center Positive (+V), symbol compliant with IEC 60417 symbol no. 5926, Blades/Input Cord: (Order Separately), Approvals: IRAM; IP42; CB 62368; CB 60950; Class I; 230V CoC Tier 2; cULus (9V only); Korea (9, 12V Only); EAC; UKCA; LPS 62368; NrCAN (9V only); UL 1310; ETL 62368; Conforms to 62368-1; Morocco; NOM (9V only); S-Mark 62368; India BIS 5, 5.95, 7.5, 9, 12, 15, 19, 24, 48V; RCM; Korea (5, 5.2, 5.95 & 7.5V Only); S-Mark 60950; ETL; CCC; CE; IRAM; CB 60335; cETLus UL1310; Fuse 60335; Fuse 60335; CE; China RoHS; Level VI; LPS 60950; RoHS; Ukraine; VCCI; WEEE; PSE; PSE; FCC; CAN ICES-3; cETLus; cETLus 60601-1 3rd; CB 60601-1;	
	<b>Model No. GTM96180-1830-12.0-T3</b>	
	<b>Part No./Ordering No. TR9CH1000LCP-IM-R6B</b>	<b>Rev B</b>

<a href="#">23214272M5701(R)</a>	Switzerland (Type J)	SEV 1011	IEC 320/C13	2500	8
<a href="#">3003322M5701(R)</a>	Taiwan (Type B)	BSMI	IEC 320/C13	2500	8
<a href="#">6363762M5701(R)</a>	Thailand (Type O)	TIS 166-2549	IEC 320/C13	2500	8
<a href="#">PZ0800100-2M5BK13H(R)</a>	UK, Hong Kong, Singapore, Gulf States (Type G)	BS 1363A	IEC 320/C13	2500	8
<a href="#">7055002M5701A(R)</a>	International	IEC 320 C14-C13	IEC 320/C13	2500	8

<b>GlobTek, Inc.</b> www.globtek.com 186 Veterans Drive, Northvale, NJ 07647 Tel. (201) 784-1000 Fax (201) 784-0111	Drawing Title: GTM96180-1830-12.0-T3, ICT / ITE / Medical Power Supply/Class 2/Household Power Supply, Efficiency Level: USA DOE Level VI / Eco-design Directive 2009/125/EC, (EU) 2019/1782, Case Color/Style: GlobTek Black, Desktop/External, Regulated Switchmode AC-DC Power Supply AC Adaptor, Input Rating: 100-240V~, 50-60 Hz, IEC 60320/C14 , Output Rating: 18W, 18.0V@1.0A, Output Configuration: 1500 mm, 18/1C + Shield Cond, UL 1185, Female Barrel 5.5 * 2.5 * 11mm with internal Spring Clip and Locking Notch or Equal, Ferrite: None, GlobTek Black, GT Cord # C5101, Pin Out: Center Positive (+V), symbol compliant with IEC 60417 symbol no. 5926, Blades/Input Cord: (Order Separately), Approvals: IRAM; IP42; CB 62368; CB 60950; Class I; 230V CoC Tier 2; cULus (9V only); Korea (9, 12V Only); EAC; UKCA; LPS 62368; NrCAN (9V only); UL 1310; ETL 62368; Conforms to 62368-1; Morocco; NOM (9V only); S-Mark 62368; India BIS 5, 5.95, 7.5, 9, 12, 15, 19, 24, 48V; RCM; Korea (5, 5.2, 5.95 & 7.5V Only); S-Mark 60950; ETL; CCC; CE; IRAM; CB 60335; cETLus UL1310; Fuse 60335; Fuse 60335; CE; China RoHS; Level VI; LPS 60950; RoHS; Ukraine; VCCI; WEEE; PSE; PSE; FCC; CAN ICES-3; cETLus; cETLus 60601-1 3rd; CB 60601-1;
	Model No. GTM96180-1830-12.0-T3
	Part No./Ordering No. TR9CH1000LCP-IM-R6B <span style="float: right;">Rev B</span>

**OUTPUT CORD AND CONNECTOR: LCL/C5101**

ACTUAL CONNECTORS, OVERMOLDS, FERRITES MAY VARY SLIGHTLY FROM THE PICTURE BELOW

CABLE TYPE	UL 1185
CABLE LENGTH (mm)	1500
CABLE TOLERANCE (mm)	+150, -0
WIRE GAUGE (AWG)	18
CONDUCTORS	1C + Shield
HANK DIMENSION (mm)	80 ± 20
CABLE / CONNECTOR OVERMOLD COLOR	GlobTek Black
FERRITE TYPE AND DIMENSION	None
FERRITE NUMBER OF TURNS <a href="#">(Definition)</a>	N/A
FERRITE DIMENSION FROM STRAIN RELIEF	N/A
FERRITE DIMENSION FROM PLUG	N/A
PLUG TYPE	Female Barrel 5.5 * 2.5 * 11mm with internal Spring Clip and Locking Notch or Equal
OVERMOLDED	Yes
OVER MOLD ORIENTATION	Straight
CONNECTOR PIN OUT	Center Positive (+V), symbol compliant with IEC 60417 symbol no. 5926
ADDITIONAL REQUIREMENTS	UL1310 Warning Label Up To 36 Volts with plugs

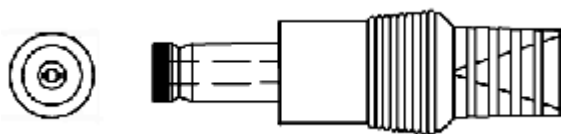

ADDITIONAL OUTPUT PLUG OPTIONS ARE AVAILABLE AT <https://www.globtek.com/connectors/>  
STANDARD PLUGS AND CONNECTORS CAN BE SEEN ONLINE AT <https://www.globtek.com/connectors/>  
CALCULATE VOLTAGE REGULATION/DROP WITH OUR ONLINE CALCULATOR: <https://en.globtek.com/output-cable-regulation-calculator/>

<p>GlobTek, Inc. www.globtek.com 186 Veterans Drive, Northvale, NJ 07647 Tel. (201) 784-1000 Fax (201) 784-0111</p>	<p>Drawing Title: GTM96180-1830-12.0-T3, ICT / ITE / Medical Power Supply/Class 2/Household Power Supply, Efficiency Level: USA DOE Level VI / Eco-design Directive 2009/125/EC, (EU) 2019/1782, Case Color/Style: GlobTek Black, Desktop/External, Regulated Switchmode AC-DC Power Supply AC Adaptor, Input Rating: 100-240V~, 50-60 Hz, IEC 60320/C14 , Output Rating: 18W, 18.0V@1.0A, Output Configuration: 1500 mm, 18/1C + Shield Cond, UL 1185, Female Barrel 5.5 * 2.5 * 11mm with internal Spring Clip and Locking Notch or Equal, Ferrite: None, GlobTek Black, GT Cord # C5101, Pin Out: Center Positive (+V), symbol compliant with IEC 60417 symbol no. 5926, Blades/Input Cord: (Order Separately), Approvals: IRAM; IP42; CB 62368; CB 60950; Class I; 230V CoC Tier 2; cULus (9V only); Korea (9, 12V Only); EAC; UKCA; LPS 62368; NrCAN (9V only); UL 1310; ETL 62368; Conforms to 62368-1; Morocco; NOM (9V only); S-Mark 62368; India BIS 5, 5.95, 7.5, 9, 12, 15, 19, 24, 48V; RCM; Korea (5, 5.2, 5.95 &amp; 7.5V Only); S-Mark 60950; ETL; CCC; CE; IRAM; CB 60335; cETLus UL1310; Fuse 60335; Fuse 60335; CE; China RoHS; Level VI; LPS 60950; RoHS; Ukraine; VCCI; WEEE; PSE; PSE; FCC; CAN ICES-3; cETLus; cETLus 60601-1 3rd; CB 60601-1;</p>	
	<p>Model No. GTM96180-1830-12.0-T3</p>	
	<p>Part No./Ordering No. TR9CH1000LCP-IM-R6B</p>	<p>Rev B</p>

**OUTPUT CONNECTOR HOOK UP**

TO ADDRESS SYSTEM-LEVEL EMI CONCERNS, FERRITE CHOKES/BEADS MAY BE ADDED/REVISED UPON REQUEST. A SAMPLE KIT OF GLOBTEK'S STANDARD FERRITES IS AVAILABLE UNDER GLOBTEK P/N: EMI-MITIGATION-KIT1

FOR ADDITIONAL INFORMATION, PLEASE READ OUR WHITE PAPER AT:

<https://en.globtek.com/technical-articles/ferrite-kit-radiated-emi-suppression-kit-for-globtek-power-supplies-cable-assemblies>

<b>GlobTek, Inc.</b> www.globtek.com 186 Veterans Drive, Northvale, NJ 07647 Tel. (201) 784-1000 Fax (201) 784-0111	Drawing Title: GTM96180-1830-12.0-T3, ICT / ITE / Medical Power Supply/Class 2/Household Power Supply, Efficiency Level: USA DOE Level VI / Eco-design Directive 2009/125/EC, (EU) 2019/1782, Case Color/Style: GlobTek Black, Desktop/External, Regulated Switchmode AC-DC Power Supply AC Adaptor, Input Rating: 100-240V~, 50-60 Hz, IEC 60320/C14 , Output Rating: 18W, 18.0V@1.0A, Output Configuration: 1500 mm, 18/1C + Shield Cond, UL 1185, Female Barrel 5.5 * 2.5 * 11mm with internal Spring Clip and Locking Notch or Equal, Ferrite: None, GlobTek Black, GT Cord # C5101, Pin Out: Center Positive (+V), symbol compliant with IEC 60417 symbol no. 5926, Blades/Input Cord: (Order Separately), Approvals: IRAM; IP42; CB 62368; CB 60950; Class I; 230V CoC Tier 2; cULus (9V only); Korea (9, 12V Only); EAC; UKCA; LPS 62368; NrCAN (9V only); UL 1310; ETL 62368; Conforms to 62368-1; Morocco; NOM (9V only); S-Mark 62368; India BIS 5, 5.95, 7.5, 9, 12, 15, 19, 24, 48V; RCM; Korea (5, 5.2, 5.95 & 7.5V Only); S-Mark 60950; ETL; CCC; CE; IRAM; CB 60335; cETLus UL1310; Fuse 60335; Fuse 60335; CE; China RoHS; Level VI; LPS 60950; RoHS; Ukraine; VCCI; WEEE; PSE; PSE; FCC; CAN ICES-3; cETLus; cETLus 60601-1 3rd; CB 60601-1;	
	Model No. GTM96180-1830-12.0-T3	
	Part No./Ordering No. TR9CH1000LCP-IM-R6B	Rev B

**LABEL:L-1186**

LABEL P/N	Standard GT
MATERIAL	Flat Thermal Transfer, Imprintable, Polyester Label and/or Pad Printed and/or Molded, and/or Laser Engraved in the case
BACKGROUND COLOR	Black if housing is Black, White or Silver if housing is White or Gray.
TEXT COLOR	White or Silver if label is Black Background for Black housing. Black if label is White or Silver background and Housing is White or Gray.
LABEL WIDTH (mm)	36.5
LABEL HEIGHT (mm)	48.5
SPECIAL BARCODE LABEL MATERIAL	No

Below is the minimum information which will appear on the label. NOTE: in the logo area additional/actual positioning of symbols and text is subjected to change as per agency updates/requirements or additional model approvals become available.  
Regulatory certifications/label markings may be in logo area on the label or molded into the case housing outside the label area.  
Information will be shown via label and/or pad printed and/or molded and/or laser engraved in the case. \* Date code markings at GlobTek option



or  
**DATE CODE B \*:**  
WWYY  
WW = WEEK  
YY = YEAR

A=ICT / ITE / Medical Power Supply/Class 2/Household Power Supply  
B=P/N: (料号) TR9CH1000LCP-IM-R6B  
C=Model (型号) GTM96180-1830-12.0-T3  
D=Input (输入)100-240V~, 50-60 Hz, 0.6 A  
E=Output (输出)18.0 V 1.0 A, 18.00W

<b>GlobTek, Inc.</b> www.globtek.com 186 Veterans Drive, Northvale, NJ 07647 Tel. (201) 784-1000 Fax (201) 784-0111	Drawing Title: GTM96180-1830-12.0-T3, ICT / ITE / Medical Power Supply/Class 2/Household Power Supply, Efficiency Level: USA DOE Level VI / Eco-design Directive 2009/125/EC, (EU) 2019/1782, Case Color/Style: GlobTek Black, Desktop/External, Regulated Switchmode AC-DC Power Supply AC Adaptor, Input Rating: 100-240V~, 50-60 Hz, IEC 60320/C14 , Output Rating: 18W, 18.0V@1.0A, Output Configuration: 1500 mm, 18/1C + Shield Cond, UL 1185, Female Barrel 5.5 * 2.5 * 11mm with internal Spring Clip and Locking Notch or Equal, Ferrite: None, GlobTek Black, GT Cord # C5101, Pin Out: Center Positive (+V), symbol compliant with IEC 60417 symbol no. 5926, Blades/Input Cord: (Order Separately), Approvals: IRAM; IP42; CB 62368; CB 60950; Class I; 230V CoC Tier 2; cULus (9V only); Korea (9, 12V Only); EAC; UKCA; LPS 62368; NrCAN (9V only); UL 1310; ETL 62368; Conforms to 62368-1; Morocco; NOM (9V only); S-Mark 62368; India BIS 5, 5.95, 7.5, 9, 12, 15, 19, 24, 48V; RCM; Korea (5, 5.2, 5.95 & 7.5V Only); S-Mark 60950; ETL; CCC; CE; IRAM; CB 60335; cETLus UL1310; Fuse 60335; Fuse 60335; CE; China RoHS; Level VI; LPS 60950; RoHS; Ukraine; VCCI; WEEE; PSE; PSE; FCC; CAN ICES-3; cETLus; cETLus 60601-1 3rd; CB 60601-1;	
	Model No. GTM96180-1830-12.0-T3	
	Part No./Ordering No. TR9CH1000LCP-IM-R6B	Rev B

AGENCY ONLINE DOCUMENTS	<a href="http://www.globtek.info/certs/GTM96180-TZ/">http://www.globtek.info/certs/GTM96180-TZ/</a>
CE EC-Declaration for Medical	<a href="http://globtek.force.com/models/ec_declaration_product?id=01ta0000007dIB5&amp;m=1">http://globtek.force.com/models/ec_declaration_product?id=01ta0000007dIB5&amp;m=1</a>
CE EC-Declaration for Industrial/Commercial/ITE	<a href="http://globtek.force.com/models/ec_declaration_product?id=01ta0000007dIB5&amp;i=2">http://globtek.force.com/models/ec_declaration_product?id=01ta0000007dIB5&amp;i=2</a>
CE EC-Declaration for Household	<a href="http://globtek.force.com/models/ec_declaration_product?id=01ta0000007dIB5&amp;h=2">http://globtek.force.com/models/ec_declaration_product?id=01ta0000007dIB5&amp;h=2</a>
UKCA-Declaration for Medical	<a href="http://globtek.force.com/models/ukca_declaration_product?id=01ta0000007dIB5&amp;m=1">http://globtek.force.com/models/ukca_declaration_product?id=01ta0000007dIB5&amp;m=1</a>
UKCA-Declaration for Industrial/Commercial/ITE	<a href="http://globtek.force.com/models/ukca_declaration_product?id=01ta0000007dIB5&amp;i=2">http://globtek.force.com/models/ukca_declaration_product?id=01ta0000007dIB5&amp;i=2</a>
UKCA-Declaration for Household	<a href="http://globtek.force.com/models/ukca_declaration_product?id=01ta0000007dIB5&amp;h=2">http://globtek.force.com/models/ukca_declaration_product?id=01ta0000007dIB5&amp;h=2</a>
Morocco SDoC Declaration	<a href="https://globtek.secure.force.com/models/Morocco_SDoC_Declaration?id=a0Oa000000MmbDvEAJ">https://globtek.secure.force.com/models/Morocco_SDoC_Declaration?id=a0Oa000000MmbDvEAJ</a>
RoHS/RoHS3 Declaration	<a href="https://www.globtek.com/pdf/rohs_cert/01ta0000007dIB5AAM">https://www.globtek.com/pdf/rohs_cert/01ta0000007dIB5AAM</a>
REACH Declaration	<a href="https://www.globtek.com/pdf/iso_certificates/REACH.pdf">https://www.globtek.com/pdf/iso_certificates/REACH.pdf</a>
Conflict Minerals Declaration	<a href="https://www.globtek.com/pdf/conflict-minerals.pdf">https://www.globtek.com/pdf/conflict-minerals.pdf</a>
Prop 65 Statement	<a href="https://en.globtek.com/prop-65-statement.pdf">https://en.globtek.com/prop-65-statement.pdf</a>
IPXY rating is based on 3rd party testing and customers should check suitability and test system level IPXY rating before ordering.	

## Regulatory Certifications/Label Markings

Below follows a link to the latest regulatory certifications and marks for this specific product. National standards as well as certification schemes are constantly changing and so is the set of certification marks and symbols applicable to this product. Various standards, marks and symbols, and certificates are subject to change at any time without notice.

Additional standards or unique country certifications are available upon request. Please contact Globtek to request a quotation.

LATEST PRODUCT/MODEL CERTIFICATIONS: <https://www.globtek.com/datasheet/w71102>

AGENCY ONLINE DOCUMENTS <http://www.globtek.info/certs/GTM96180-TZ/>



(E1) Earthed output

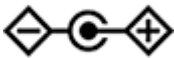

Center Positive (+V), symbol compliant with IEC 60417 symbol no. 5926

<b>GlobTek, Inc.</b> www.globtek.com 186 Veterans Drive, Northvale, NJ 07647 Tel. (201) 784-1000 Fax (201) 784-0111	Drawing Title: GTM96180-1830-12.0-T3, ICT / ITE / Medical Power Supply/Class 2/Household Power Supply, Efficiency Level: USA DOE Level VI / Eco-design Directive 2009/125/EC, (EU) 2019/1782, Case Color/Style: GlobTek Black, Desktop/External, Regulated Switchmode AC-DC Power Supply AC Adaptor, Input Rating: 100-240V~, 50-60 Hz, IEC 60320/C14 , Output Rating: 18W, 18.0V@1.0A, Output Configuration: 1500 mm, 18/1C + Shield Cond, UL 1185, Female Barrel 5.5 * 2.5 * 11mm with internal Spring Clip and Locking Notch or Equal, Ferrite: None, GlobTek Black, GT Cord # C5101, Pin Out: Center Positive (+V), symbol compliant with IEC 60417 symbol no. 5926, Blades/Input Cord: (Order Separately), Approvals: IRAM; IP42; CB 62368; CB 60950; Class I; 230V CoC Tier 2; cULus (9V only); Korea (9, 12V Only); EAC; UKCA; LPS 62368; NrCAN (9V only); UL 1310; ETL 62368; Conforms to 62368-1; Morocco; NOM (9V only); S-Mark 62368; India BIS 5, 5.95, 7.5, 9, 12, 15, 19, 24, 48V; RCM; Korea (5, 5.2, 5.95 & 7.5V Only); S-Mark 60950; ETL; CCC; CE; IRAM; CB 60335; cETLus UL1310; Fuse 60335; Fuse 60335; CE; China RoHS; Level VI; LPS 60950; RoHS; Ukraine; VCCI; WEEE; PSE; PSE; FCC; CAN ICES-3; cETLus; cETLus 60601-1 3rd; CB 60601-1;	
	Model No. GTM96180-1830-12.0-T3	
	Part No./Ordering No. TR9CH1000LCP-IM-R6B	Rev B

## PACKAGING

Packing Spec P/N	Standard DT, Individually Box, GT User Manual
Box Qty	60
Gift Box Size (mm)	147*100*33
Gift Box Color	White
Master Carton Size (mm)	455 x 405 x 220
Master Carton Cubic Volume (m³)	0.04
Master GW (Kg)	13.2 kg
BLADES INCLUDED	None: (Order Separately)
BLADE/CORD INSTALLED	None: (Order Separately)
USER MANUAL*	809-DESKTOPUSERMANUAL on A4 paper
USER MANUAL WEB LINK	<a href="https://en.globtek.com/pdf/809-DESKTOPUSERMANUAL.jpg">https://en.globtek.com/pdf/809-DESKTOPUSERMANUAL.jpg</a>

\* This specification sheet is considered the user manual for all applications. It is expected that the buyer of this product will use it to formulate their own user manual for their end product and a user manual specifically for the power adapter is not usually required. If a user manual is not specifically listed above then none will be provided with this unit.

If specific packaging is required, this section must specify all requirements and note "no exceptions". If this section does not specify packaging, it is subject to change without notice at GlobTek's discretion

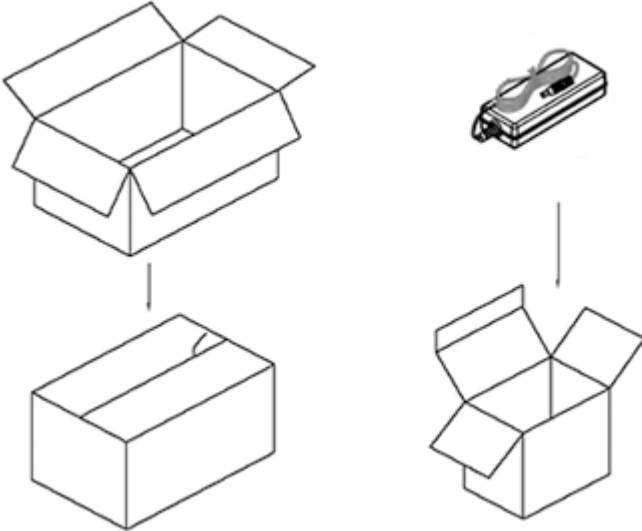

## PROPRIETARY INFORMATION



<b>GlobTek, Inc.</b> www.globtek.com 186 Veterans Drive, Northvale, NJ 07647 Tel. (201) 784-1000 Fax (201) 784-0111	Drawing Title: GTM96180-1830-12.0-T3, ICT / ITE / Medical Power Supply/Class 2/Household Power Supply, Efficiency Level: USA DOE Level VI / Eco-design Directive 2009/125/EC, (EU) 2019/1782, Case Color/Style: GlobTek Black, Desktop/External, Regulated Switchmode AC-DC Power Supply AC Adaptor, Input Rating: 100-240V~, 50-60 Hz, IEC 60320/C14 , Output Rating: 18W, 18.0V@1.0A, Output Configuration: 1500 mm, 18/1C + Shield Cond, UL 1185, Female Barrel 5.5 * 2.5 * 11mm with internal Spring Clip and Locking Notch or Equal, Ferrite: None, GlobTek Black, GT Cord # C5101, Pin Out: Center Positive (+V), symbol compliant with IEC 60417 symbol no. 5926, Blades/Input Cord: (Order Separately), Approvals: IRAM; IP42; CB 62368; CB 60950; Class I; 230V CoC Tier 2; cULus (9V only); Korea (9, 12V Only); EAC; UKCA; LPS 62368; NrCAN (9V only); UL 1310; ETL 62368; Conforms to 62368-1; Morocco; NOM (9V only); S-Mark 62368; India BIS 5, 5.95, 7.5, 9, 12, 15, 19, 24, 48V; RCM; Korea (5, 5.2, 5.95 & 7.5V Only); S-Mark 60950; ETL; CCC; CE; IRAM; CB 60335; cETLus UL1310; Fuse 60335; Fuse 60335; CE; China RoHS; Level VI; LPS 60950; RoHS; Ukraine; VCCI; WEEE; PSE; PSE; FCC; CAN ICES-3; cETLus; cETLus 60601-1 3rd; CB 60601-1;	
	Model No. GTM96180-1830-12.0-T3	
	Part No./Ordering No. TR9CH1000LCP-IM-R6B	Rev B

### INSTRUCTIONS TO THE OEM SYSTEMS ENGINEER

It is the responsibility of the OEM systems engineer to provide the end system user instructions and warnings for the use of this product in the end system.

If an input cord is required for this product, AC Mains voltage should be provided to the power supply by a power supply cord approved to the national standards of the country in which it will be used.

This product is not designed to be repaired. No serviceable parts inside. A blown internal fuse is an indication of catastrophic failure of circuit component(s). If a Failure Analysis is required for a failed power supply/battery charger, please return the damaged unit to GlobTek for an accurate determination of the root cause of the failure.

EMC Compliance of the complete OEM product, including the GlobTek power supply/battery charger needs to be verified by the OEM systems engineer.

### INSTRUCTION SHEET

N/A

<p>GlobTek, Inc. www.globtek.com 186 Veterans Drive, Northvale, NJ 07647 Tel. (201) 784-1000 Fax (201) 784-0111</p>	<p>Drawing Title: GTM96180-1830-12.0-T3, ICT / ITE / Medical Power Supply/Class 2/Household Power Supply, Efficiency Level: USA DOE Level VI / Eco-design Directive 2009/125/EC, (EU) 2019/1782, Case Color/Style: GlobTek Black, Desktop/External, Regulated Switchmode AC-DC Power Supply AC Adaptor, Input Rating: 100-240V~, 50-60 Hz, IEC 60320/C14 , Output Rating: 18W, 18.0V@1.0A, Output Configuration: 1500 mm, 18/1C + Shield Cond, UL 1185, Female Barrel 5.5 * 2.5 * 11mm with internal Spring Clip and Locking Notch or Equal, Ferrite: None, GlobTek Black, GT Cord # C5101, Pin Out: Center Positive (+V), symbol compliant with IEC 60417 symbol no. 5926, Blades/Input Cord: (Order Separately), Approvals: IRAM; IP42; CB 62368; CB 60950; Class I; 230V CoC Tier 2; cULus (9V only); Korea (9, 12V Only); EAC; UKCA; LPS 62368; NrCAN (9V only); UL 1310; ETL 62368; Conforms to 62368-1; Morocco; NOM (9V only); S-Mark 62368; India BIS 5, 5.95, 7.5, 9, 12, 15, 19, 24, 48V; RCM; Korea (5, 5.2, 5.95 &amp; 7.5V Only); S-Mark 60950; ETL; CCC; CE; IRAM; CB 60335; cETLus UL1310; Fuse 60335; Fuse 60335; CE; China RoHS; Level VI; LPS 60950; RoHS; Ukraine; VCCI; WEEE; PSE; PSE; FCC; CAN ICES-3; cETLus; cETLus 60601-1 3rd; CB 60601-1;</p>	
	<p>Model No. GTM96180-1830-12.0-T3</p>	
	<p>Part No./Ordering No. TR9CH1000LCP-IM-R6B</p>	<p>Rev B</p>

