

# AV series

Security pushbutton switches • Ø 22 or 24 mm •  
with large actuator • momentary NC+NO



## DISTINCTIVE FEATURES

- Large actuator
- Low profile option
- Momentary (combined NC+NO)
- Anodized actuators
- Sealed to IP65



## ENVIRONMENTAL SPECIFICATIONS

- Front panel sealing : IP65 according to IEC 60529
- Operating temperature : -20°C to +55°C (-4 °F to +131 °F)



## ELECTRICAL SPECIFICATIONS

- Max. current/voltage rating with resistive load (microswitch) : 5 A 250 VAC
- Initial contact resistance : 100 mΩ max.
- Insulation resistance : 1,000 MΩ min. at 500 VDC
- Dielectric strength : 2,000 Vrms 50 Hz min. between terminals and frame
- Electrical life : 1,000,000 cycles at 1 A 250 VAC  
100,000 cycles at full load



## GENERAL SPECIFICATIONS

- Torque : 1.5 Nm min. - 4 Nm max. applied to nut
- Panel thickness : 1 (.039) to 6 mm (.236) max.
- Low level or mechanical life : 1,000,000 cycles
- Hand soldering : 300 °C (572 °F), 5 sec. max.



## MATERIALS

- Case : polyester, glass filled
- Contacts : silver/nickel alloy
- Bushing and actuator : see next page.

The company reserves the right to change specifications without notice.



# AV series

Security pushbutton switches •  
Ø 22 or 24 mm • with large actuator • momentary NC+NO



## ELECTRICAL FUNCTIONS

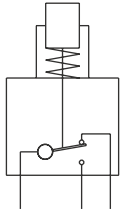

Combined NC+NO



## MOUNTING

- Panel cut-out : Ø 22.2 mm (.874) or Ø 24.2 mm (.952)
- Min. pitch for matrix mounting :  
30 mm x 30 mm (1.181x1.181)  
or 33 mm x 33 mm (1.299x1.299)

# AV series

Security pushbutton switches •  
 Ø 22 or 24 mm • with large actuator • momentary NC+NO



## BUILD YOUR PART NUMBER

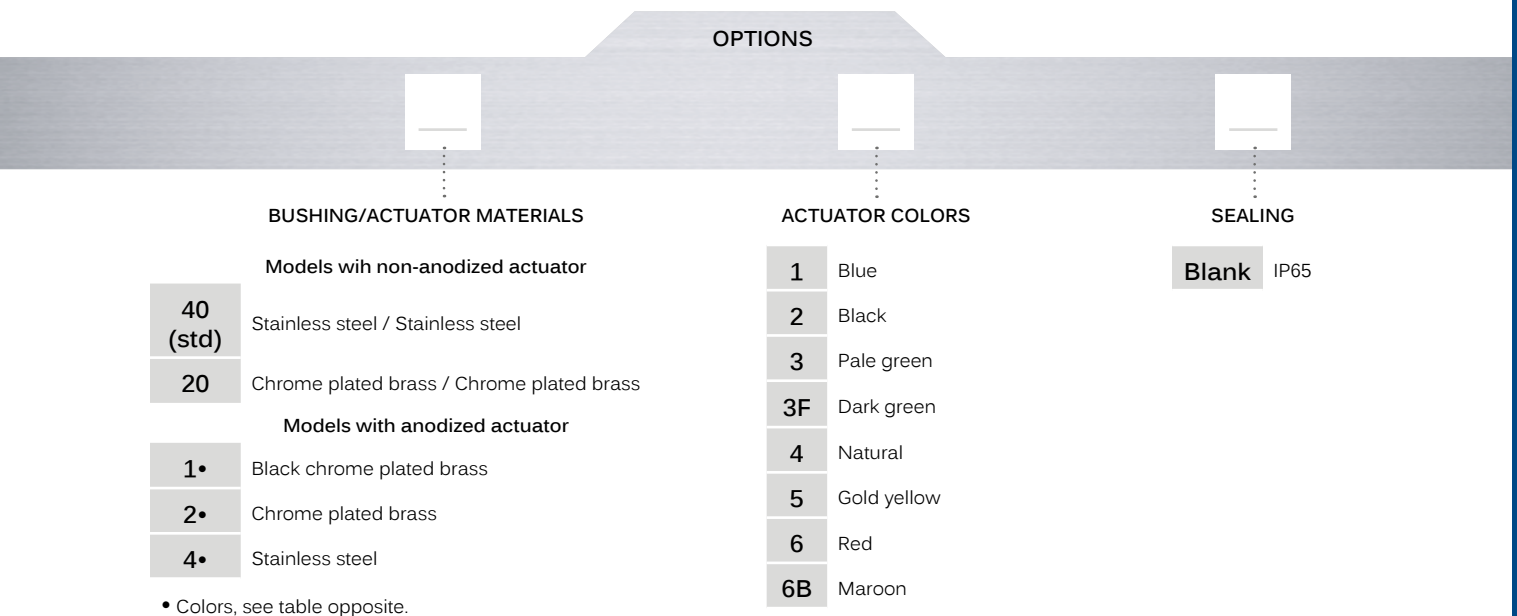
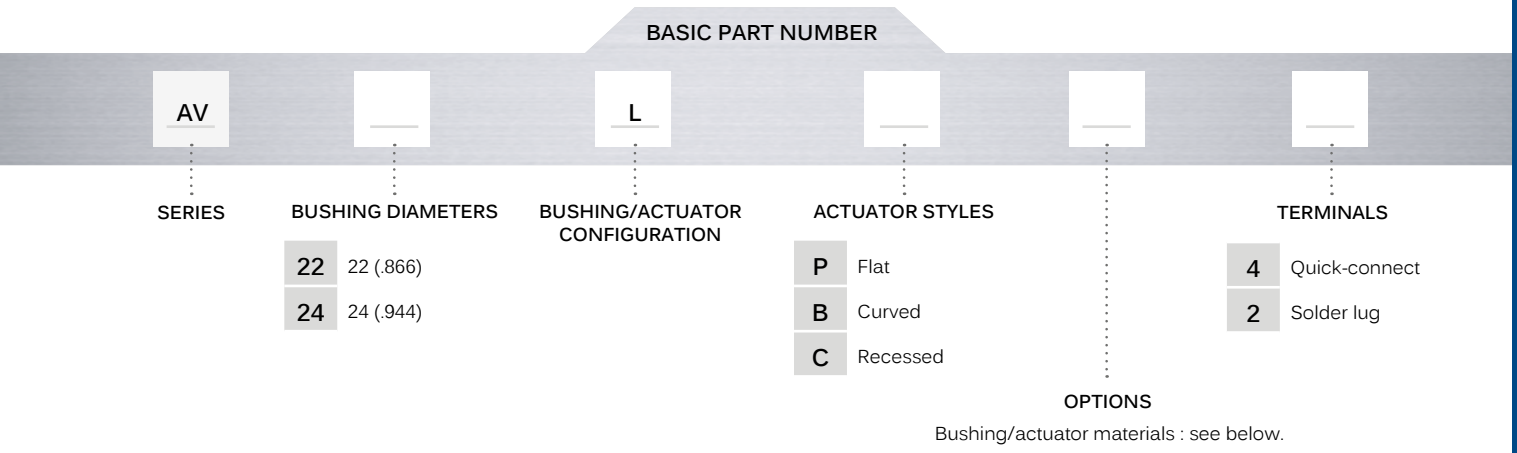

## ABOUT THIS SERIES

On the following pages, you will find successively basic part numbers of switches and options in the same order as in above chart.

**Notice:** please note that not all combinations of above numbers are available. Refer to the following pages for further information.

**Mounting accessories:** standard hardware supplied : 1 hex nut and 1 O-ring. Standard and special hardware is presented in the "Hardware" section of website.

# AV series

Security pushbutton switches •  
 Ø 22 or 24 mm • with large actuator • momentary NC+NO

## BUSHING Ø 22 (.866) - FLAT ACTUATOR



Quick-connect terminals

AV22LP••4



Solder lug terminals

AV22LP••2



## BUSHING Ø 22 (.866) - CURVED OR RECESSED ACTUATOR



CURVED ACTUATOR  
 Quick-connect terminals

AV22LB••4



Solder lug terminals

AV22LB••2



RECESSED ACTUATOR  
 Quick-connect terminals

AV22LC••4



Solder lug terminals

AV22LC••2



## BUSHING Ø 24 (.944) - FLAT ACTUATOR LOW PROFILE



Quick-connect terminals

AV24LP••4



Solder lug terminals

AV24LP••2



## BUSHING Ø 24 (.944) - CURVED OR RECESSED ACTUATOR - LOW PROFILE



CURVED ACTUATOR  
 Quick-connect terminals

AV24LB••4



Solder lug terminals

AV24LB••2



RECESSED ACTUATOR  
 Quick-connect terminals

AV24LC••4



Solder lug terminals

AV24LC••2



→ O-RING

Hex nut 25 (.984) across flats

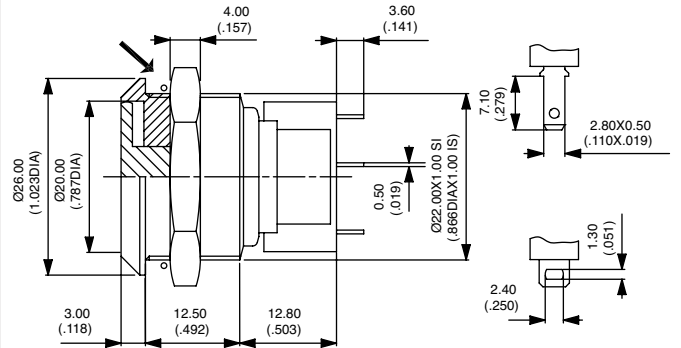

→ O-RING

Hex nut 25 (.984) across flats

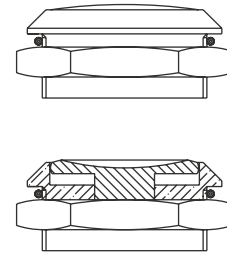

→ O-RING

Hex nut 27 (1.062) across flats

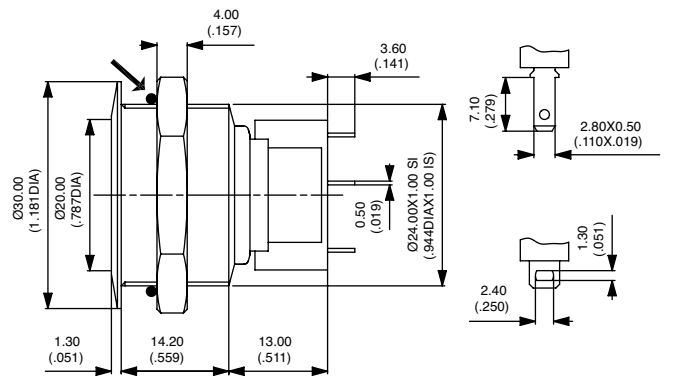

→ O-RING

Hex nut 27 (1.062) across flats

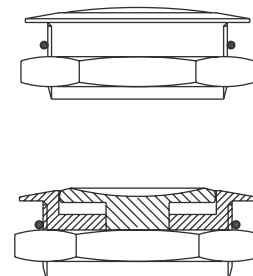

# AV series

Security pushbutton switches •  
Ø 22 or 24 mm • with large actuator • momentary NC+NO

## BUSHING/ACTUATOR MATERIALS

BASIC P/N



MODELS WITH NON-ANODIZED ACTUATOR		
CODE	BUSHING	ACTUATOR
<b>40 (std)</b>	Stainless steel	Stainless steel
<b>20</b>	Chrome plated brass	Chrome plated brass

MODELS WITH ANODIZED ACTUATOR		
CODE	BUSHING	ACTUATOR
<b>1•</b>	Black chrome plated brass	Replace • with one of the following codes : <b>1</b> : blue - <b>2</b> : black - <b>3</b> : pale green - <b>3F</b> : dark green- <b>4</b> : natural - <b>5</b> : gold yellow - <b>6</b> : red - <b>6B</b> : marron
<b>2•</b>	Chrome plated brass	
<b>4•</b>	Stainless steel	