

REVISIONS					
REV	ECO	DESCRIPTION	DATE	BY	APPR
A1	--	RELEASE NEW PRODUCT	19/AUG/20	IAN	Tommy

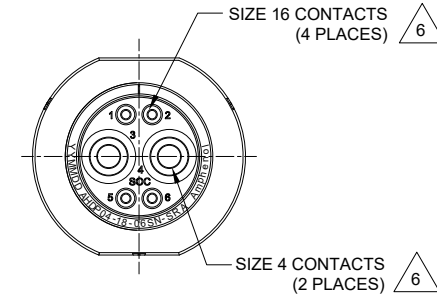
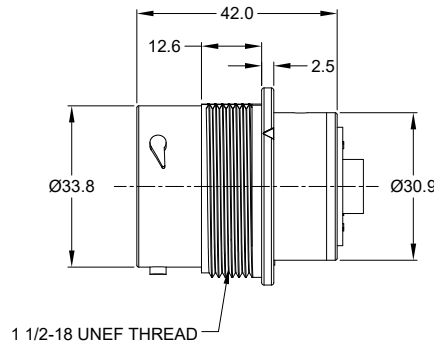
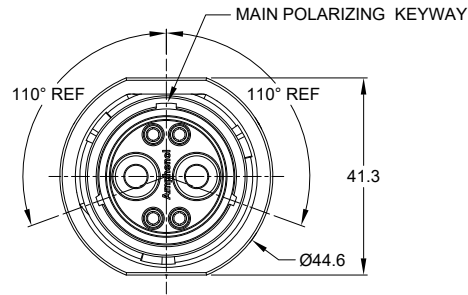

NOTES: UNLESS OTHERWISE SPECIFIED

- MATERIAL:
HOUSING: THERMOPLASTIC; BLACK
SEAL: SILICONE RUBBER
- MODIFICATIONS: THREADED ADAPTER;
STANDARD DIA. WIRE SEAL
- SPECIFICATIONS:
3.1 OPERATING TEMPERATURE: -55°C TO +125°C.
3.2 DIELECTRIC WITHSTANDING VOLTAGE: LESS THAN 2 MILLIAMPS CURRENT LEAKAGE @ 1500 VOLTS AC.
3.3 INSULATION RESISTANCE: 1000 MEGOHM MIN @ 25°C.
3.4 MOISTURE RESISTANCE: IP67&IP69K (MATED CONDITION).
3.5 MATING CYCLE DURABILITY: 100 CYCLES
3.6 RoHS COMPLIANT
- MATING PART: AHDP06-18-06P* (* = SEAL TYPE) (NOT C030 OPTION)
- ALL DIMENSIONS ARE FOR REFERENCE USE ONLY.

△ CONTACT SIZE AND WIRE RANGE:

CONTACT SIZE	MIN. INSUL O.D.	MAX. INSUL O.D.	TYPICAL WIRE RANGE	CURRENT RATING
16	2.54 mm (.100in)	3.40 mm (.134 in)	14-20 AWG (2.0-0.5mm ²)	13 AMPS
4	6.63 mm (.261in)	7.41mm (.292 in)	6 AWG (16.0-13.0mm ²)	100 AMPS

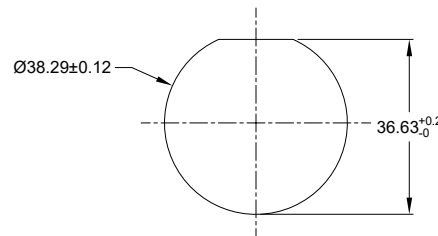

RECOMMENDED PANEL MOUNTING HOLE
RECOMMENDED PANEL THICKNESS:1.6 TO 4.7MM

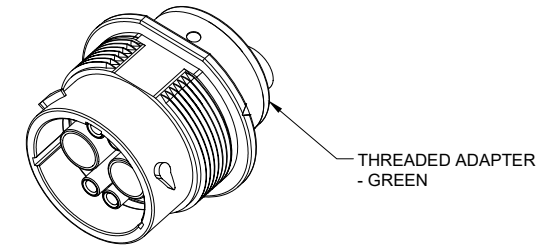



AHDP04-18-06SN-SRA		REF:HDP24-18-6SN		
PART NUMBER		DESCRIPTION		
QUANTITY	MATERIALS LIST			ITEM
UNLESS OTHERWISE SPECIFIED 1) All dimensions are in metric(mm). 2) Tolerances are as follows: 1 PL DEC ±0.30 Fractions ±1/64 2 PL DEC ±0.15 Angles ±1° 3 PL DEC ±0.08 3) Note reference = △		SIGNATURES DATE DRAWN: IAN XIAO 19/AUG/20 CHECKED: Orion 20/AUG/20 ENGINEER: APPROVAL: Tommy 21/AUG/20		Amphenol Sine Systems - www.amphenol-sine.com 44724 Morley Drive Clinton Township, MI 48036
MATERIAL SPECIFICATIONS:		CUSTOMER:		
PROCESS SPECIFICATIONS:		THIS DRAWING IS SUPPLIED FOR INFORMATION ONLY. DESIGN FEATURES, SPECIFICATIONS AND PERFORMANCE DATA SHOWN HEREON ARE THE PROPERTY OF THE AMPHENOL CORPORATION. NO RIGHTS OF REPRODUCTION ARE IMPLIED. ALL DIMENSIONS ARE SUBJECT TO NORMAL MANUFACTURING VARIATIONS.		RECEPTACLE, 18 SZ, 6 POS, SOCKET CONTACT STANDARD DIA. SEAL, DURAMATE AHDP SERIES SIZE: B C- TYPE: NONE DWG NO: AHDP04-18-06SN-SRA REVISION: A1
NEXT ASSY:		SCALE: NONE		SHEET 1 OF 1

TITLE: RECEPTACLE, 18 SZ, 6 POS, SOCKET CONTACT, STD DIA. SEAL, DURAMATE AHDP SERIES DWG NO: AHDP04-18-06SN-SRA REV: A1 SH: 1 OF: 1



AT Series™ - Contact Size 16 Options

Machined Contacts, Sockets & Pins				
Part Number	Description	Size	AWG	Type
AT60-215-1631	Male Contact - Pin, Gold-plated	16	14	Machined
AT62-209-1631	Female Contact - Socket, Gold-plated	16	14	Machined
AT60-215-16141	Male Contact - Pin, Nickel-plated	16	14	Machined
AT62-209-16141	Female Contact - Socket, Nickel-plated	16	14	Machined
AT60-202-1631	Male Contact - Pin, Gold-plated	16	16-20	Machined
AT62-201-1631	Female Contact - Socket, Gold-plated	16	16-20	Machined
AT60-202-16141	Male Contact - Pin, Nickel-plated	16	16-20	Machined
AT62-201-16141	Female Contact - Socket, Nickel-plated	16	16-20	Machined
AT60-202-1631-22	Male Contact - Pin, Gold-plated	16	22-24	Machined
AT62-201-1631-22	Female Contact - Socket, Gold-plated	16	22-24	Machined
AT60-202-16141-22	Male Contact - Pin, Nickel-plated	16	22-24	Machined
AT62-201-16141-22	Female Contact - Socket, Nickel-plated	16	22-24	Machined

Tooling - Machined Contacts		
Part	Part Number	Description
	CA-5D12	Universal Hand Crimp Tool, Size 12/16/20 (Machined contacts only)
	CA-5E12	Pneumatic Crimp Tool, Size 12/16/20 (Machined contacts only)

Contact Removal Tools		
Part	Part Number	Description
	ATRT-100	Used for removal of contacts for A Series™ products
	AT11-310-1605	Contact Removal Tool, Plastic, Size 16
	A114017	Sealing Plug, Size 16, White





Stamped & Formed Contacts, Sockets & Pins				
Part Number	Description	Size	AWG	Type
AT60-14-0144	Male Contact - Pin, Gold-plated	16	14-16	Stamped & Formed
AT62-14-0144	Female Contact - Socket, Gold-plated	16	14-16	Stamped & Formed
AT60-14-0122	Male Contact - Pin, Nickel-plated	16	14-16	Stamped & Formed
AT62-14-0122	Female Contact - Socket, Nickel-plated	16	14-16	Stamped & Formed
AT60-16-0144	Male Contact - Pin, Gold-plated	16	16-18	Stamped & Formed
AT62-16-0144	Female Contact - Socket, Gold-plated	16	16-18	Stamped & Formed
AT60-16-0122	Male Contact - Pin, Nickel-plated	16	16-18	Stamped & Formed
AT62-16-0122	Female Contact - Socket, Nickel-plated	16	16-18	Stamped & Formed
AT60-16-0644	Male Contact - Pin, Gold-plated	16	18-20	Stamped & Formed
AT62-16-0644	Female Contact - Socket, Gold-plated	16	18-20	Stamped & Formed
AT60-16-0622	Male Contact - Pin, Nickel-plated	16	18-20	Stamped & Formed
AT62-16-0622	Female Contact - Socket, Nickel-plated	16	18-20	Stamped & Formed
AT60-16-0844	Male Contact - Pin, Gold-plated	16	20-22	Stamped & Formed
AT62-16-0844	Female Contact - Socket, Gold-plated	16	20-22	Stamped & Formed
AT60-16-0822	Male Contact - Pin, Nickel-plated	16	20-22	Stamped & Formed
AT62-16-0822	Female Contact - Socket, Nickel-plated	16	20-22	Stamped & Formed

Tooling - Stamped & Formed Contacts		
Part	Part Number	Description
	MFX-3950	Crimp Die - Size 16, 18-20AWG (S&F contacts only)
	MFX-3953	Crimp Die - Size 16, 16-18AWG (S&F contacts only)
	MFX-3975	Crimp Die - Size 16, 14-16AWG (S&F contacts only)
	MFX-3990	Crimp Die - Size 16, 20-22AWG (S&F contacts only)
	ATT-16-00	Hand Crimp Tool - Size 16, 14-16AWG (S&F contacts only)
	ATT-16-01	Hand Crimp Tool - Size 16, 18-20AWG (S&F contacts only)
	ATT-1612-03	Hand Crimp Tool - Size 16, 20-22AWG (S&F contacts only)

Amphenol Sine Systems
 44724 Morley Drive
 Clinton Township, MI 48036 USA
www.amphenol-sine.com
 09/2021

DuraMate™ ATHD Series™ - Contact Size 4 Options

Machined Contacts, Pins and Sockets					
Part Number	Description	Size	AWG	Type	Amps
AT60-203-04141-4	Male Contact - Pin, Copper Alloy, Nickel-Plated	4	4	Machined	100A
AT60-204-0490	Male Contact - Pin, Copper Alloy, Nickel-Plated	4	6	Machined	100A
AT62-203-04141-4	Female Contact - Socket, Copper Alloy, Nickel-Plated	4	4	Machined	100A
AT62-203-04141	Female Contact - Socket, Copper Alloy, Nickel-Plated	4	6	Machined	100A

Tooling - Machined Contacts		
Part	Part Number	Description
	WA23	Heavy Duty Pneumatic Crimp Tool -Uses Universal Positioner Part No. WA23-101DA and Crimp Locator MFX-3961
	WA23-138DA	Die Assembly -for Heavy Duty Pneumatic Crimp Tool, Size 4
	WA23-11	Contact Locator, Size 4
	96-978-22	Crimper and Dies -for Size 10mm ² -185mm ² Wires

Contact Removal Tools		
Part	Part Number	Description
	AT11-027-0405	Contact Removal Tool, Plastic, Size 4, 4AWG