

PHOTO REFLECTOR

■FEATURES

- Miniature, thin package : 1.06 X1.46 X0.5mm
- Built-in visible light cut-off filter function.
- Pb free solder re-flowing permitted : 260°C, 2times
- Halogen free, Pb free, Compliant with RoHS directive

■GENERAL DESCRIPTION

The NJL5912R is the compact surface mount type photo reflector, which is built in a high Brightness Infrared LED and a high sensitive photo transistor.

This product has applied the COBP technology and has realized the thinness 0.5mm.

■APPLICATION

- Detecting the location of Lens unit for Cellular Phone's camera module
- Detecting the needle position for radio controlled watch
- Detecting the original point of encoder

■BLOCK DIAGRAM

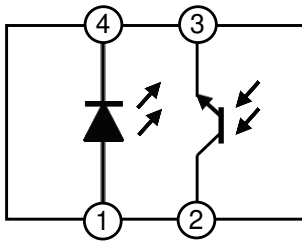

- 1. LIRA
- 2. PC
- 3. PE
- 4. LIRK

■PIN CONFIGURATION

PIN NO.	SYMBOL	DESCRIPTION
1	LIRA	Anode for IR LED
2	PC	Collector for PTr
3	PE	Emitter for PTr
4	LIRK	Cathode for IR LED

(Top View)

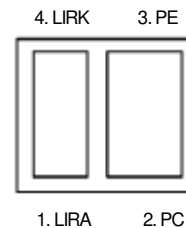

■ORDERING INFORMATION

PART NUMBER	PACKAGE OUTLINE	RoHS	HALOGEN-FREE	TERMINAL FINISH	MARKING	WEIGHT (mg)	MOQ(pcs)
NJL5912R	COBP	✓	✓	Au	No marking	1.5	3,000

■ABSOLUTE MAXIMUM RATINGS (Ta=25 °C)

PARAMETER	SYMBOL	RATINGS	UNIT
Emitter			
Forward Current (Continuous)	IF	20	mA
Reverse Voltage (Continuous)	VR	6	V
Power Dissipation	PD	45	mW
Detector			
Collector - Emitter Voltage	VCEO	16	V
Emitter - Collector Voltage	VECO	6	V
Collector Current	IC	10	mA
Collector Power Dissipation	PD	25	mW
Coupled			
Total Power Dissipation	Ptot	60	mW
Operating Temperature Range	Topr	-30 to +85	°C
Storage Temperature Range	Tstg	-40 to +100	°C
Reflow Soldering Temperature	Tsol	260	°C

■ELECTRO-OPTICAL CHARACTERISTICS (Ta=25 °C)

PARAMETER	SYMBOL	TEST CONDITION	MIN.	TYP.	MAX.	UNIT
Emitter						
Forward Voltage	VF	IF=4mA	1.1	—	1.5	V
Reverse Current	IR	VR=6V	—	—	10	μA
Capacitance	Ct	VR=0V,f=1MHz	—	25	—	pF
Detector						
Dark Current	ICEO	VCE=10V	—	—	0.5	μA
Collector - Emitter Voltage	VCEO	ICE=100μA	16	—	—	V
Coupled						
Output Current *1	IO	IF=4mA, VCE=2V, D=1.2mm *3	600	—	2,200	μA
Operating Dark Current *2	ICEOD	IF=4mA, VCE=2V	—	—	2	μA
Response Time(Rise/Fall)	tr	IO=1200μA, VCE=2V, RL=1kΩ, D=1.2mm *3	—	7	—	μs
	tf	IO=1200μA, VCE=2V, RL=1kΩ, D=1.2mm *3	—	8	—	μs

*1 Refer to OUTPUT CURRENT TEST CONDITION

*2 ICEOD may increase according to the periphery situation of the surface mounted product.

*3 Distance from the package undersurface to the aluminum evaporation surface.

■ OUTPUT CURRENT TEST CONDITION

The infrared signal from LED is reflected at the aluminum surface

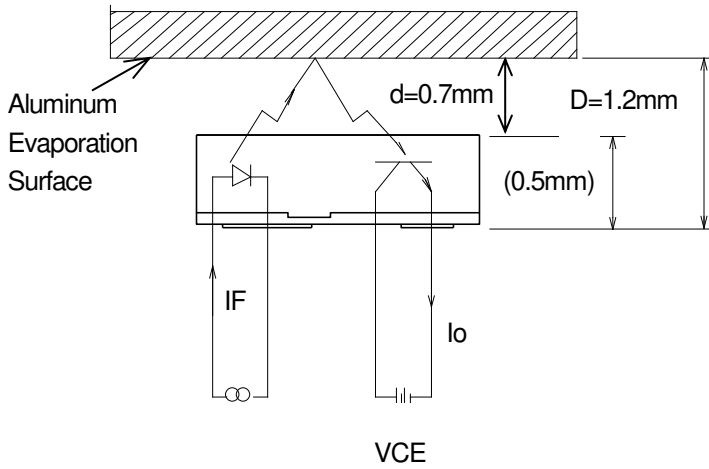

■ DARK CURRENT TEST CONDITION

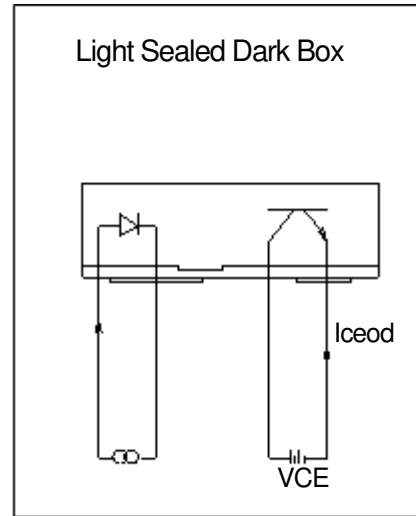

■ RESPONSE TIME TEST CONDITION

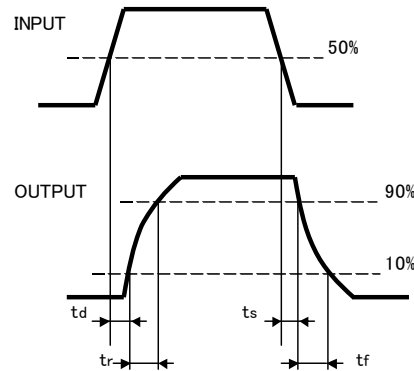
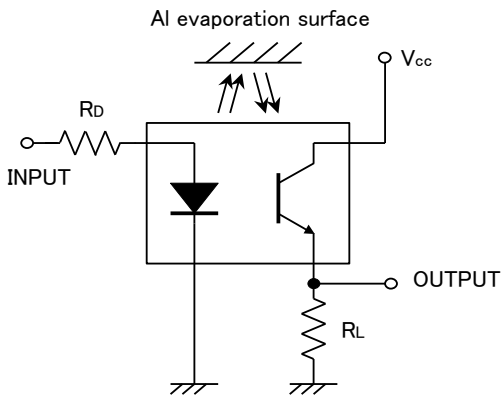

■ EDGE RESPONSE TEST CONDITION

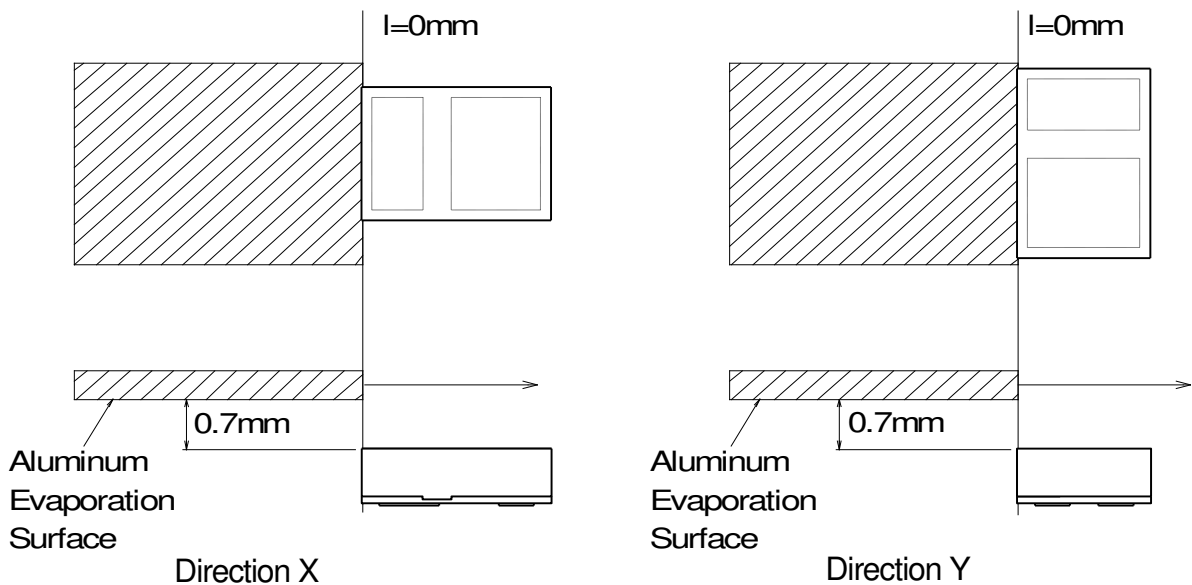

Power Dissipation vs. Temperature

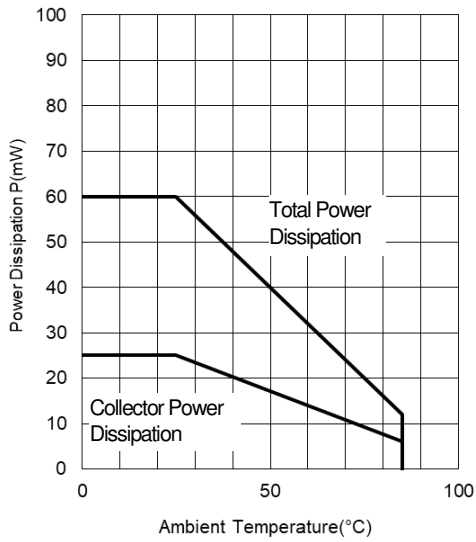

Forward Current vs. Temperature

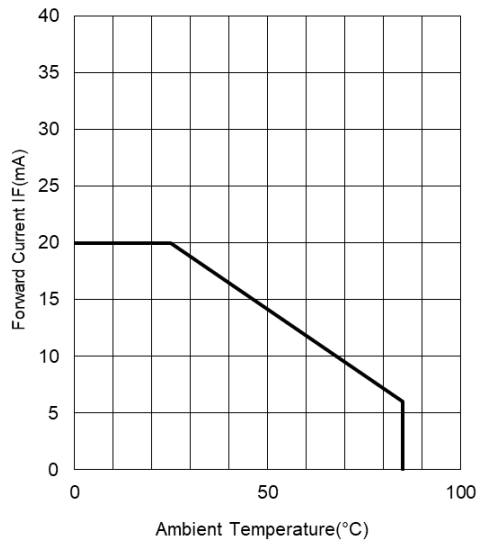

■ **TYPICAL CHARACTERISTICS**

Forward Voltage vs. Forward Current

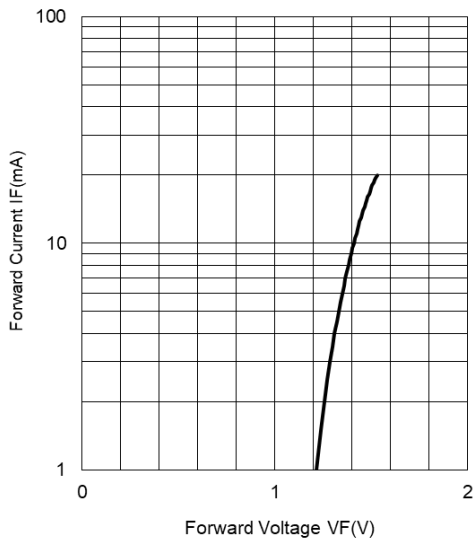

Forward Voltage vs. Temperature

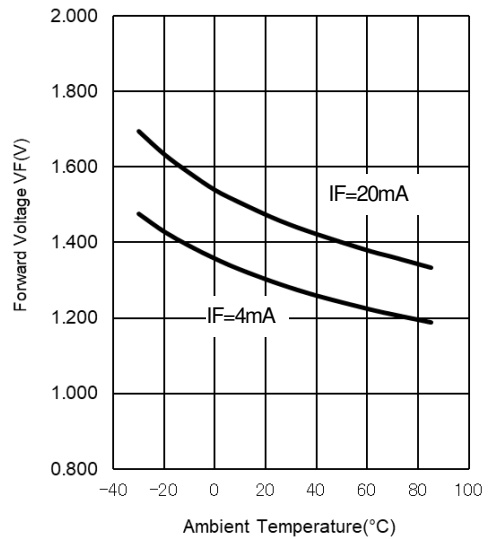

Dark Current vs. Temperature

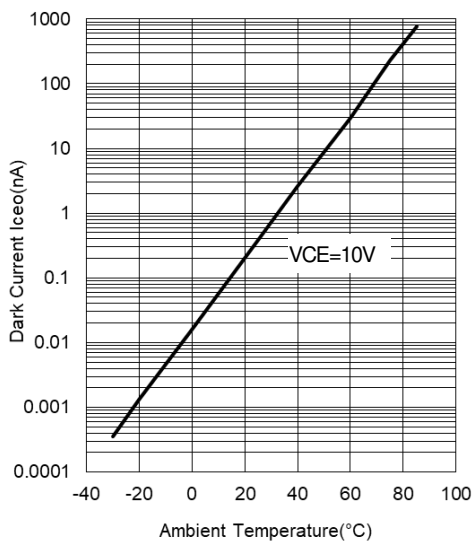

Operating Dark Current vs. Temperature

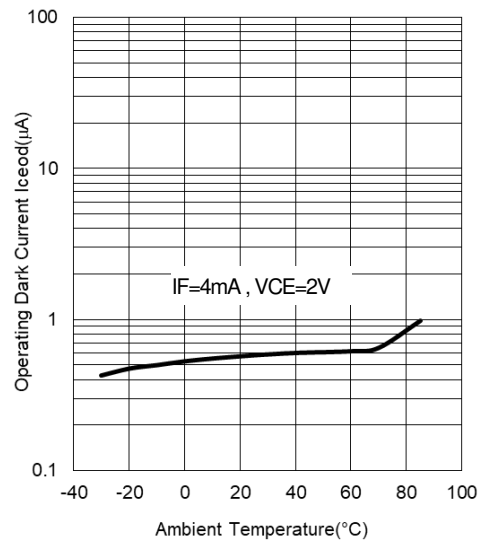

Output Current vs. Forward Current (Ta=25°C)

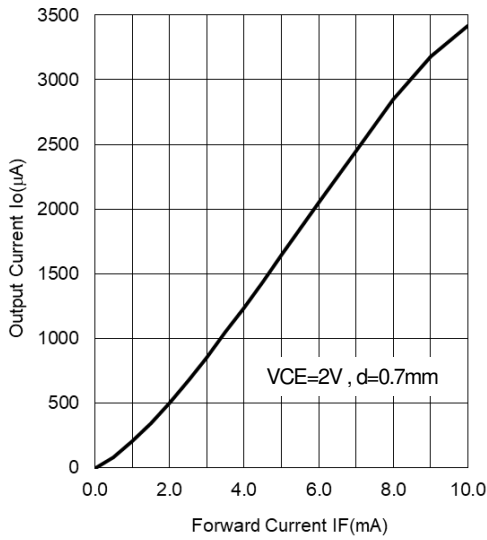

Output Current vs. Temperature

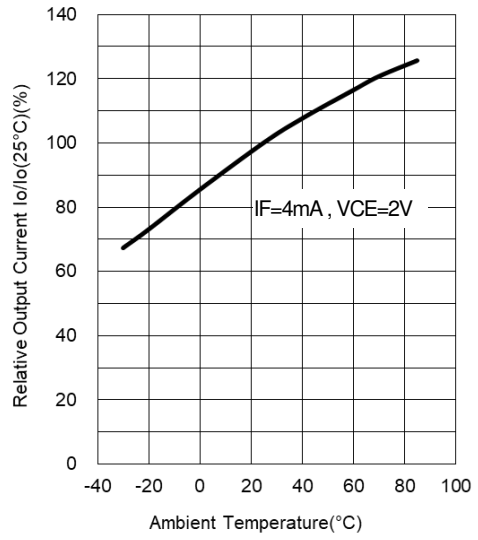

Output Characteristics (Ta=25°C)

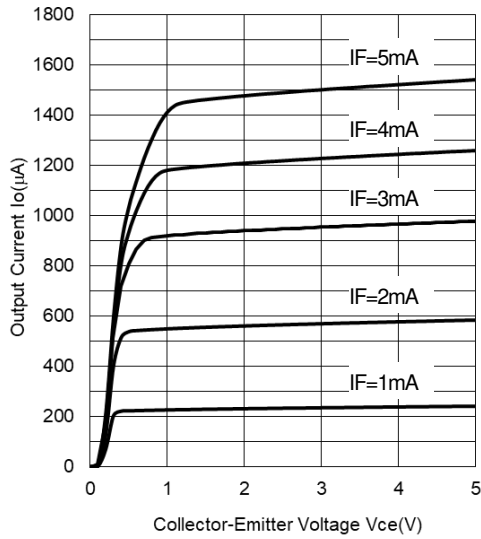

Vce Saturation (Ta=25°C)

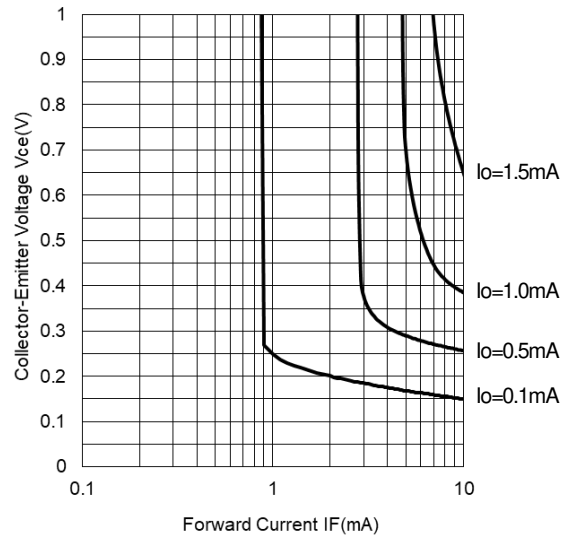

Output Current vs. Distance (Ta=25°C)

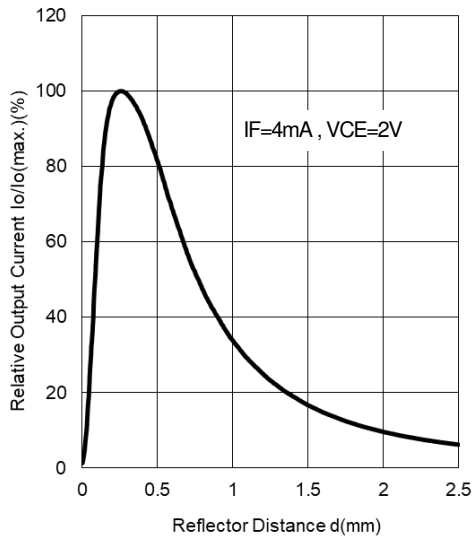

Output Current vs. Edge Distance (Ta=25°C)

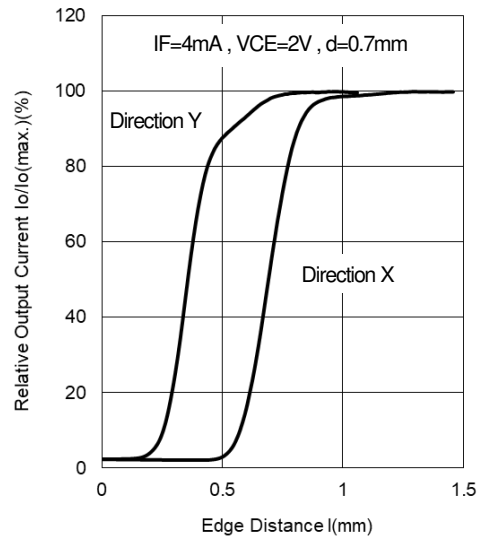

**Spectral Response (Ta=25°C)
Emitter**

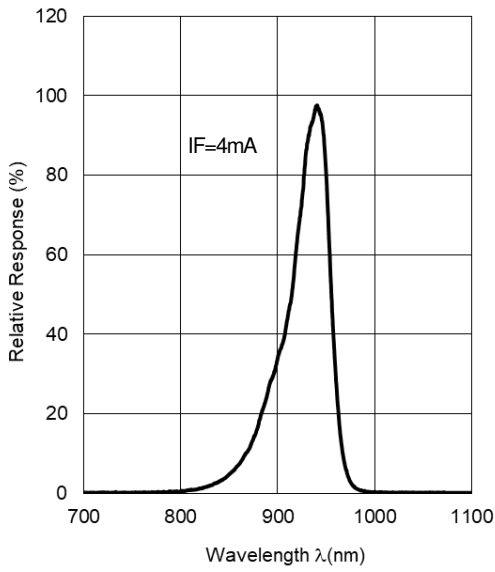

**Spectral Response (Ta=25°C)
Detector**

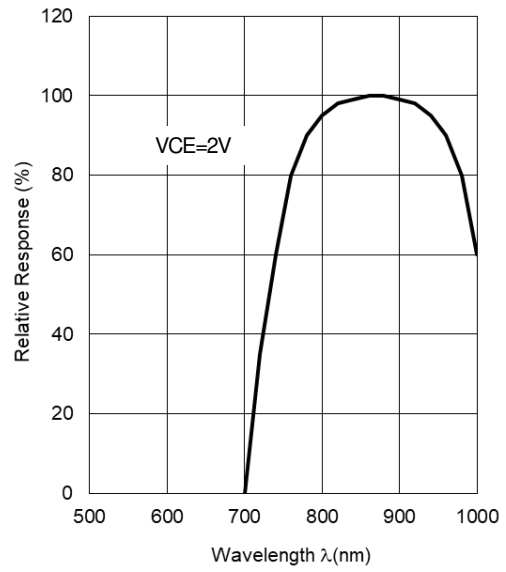

**Switching Time vs. Load Resistance
(Ta=25°C)**

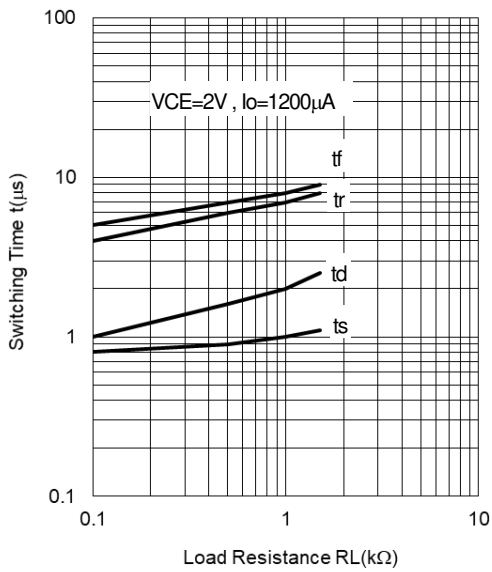

■APPLICATION NOTE

(1) Attention in handling

Treat not to touch the light receiving and light emitting part.

Avoid to adhering the dust and any other foreign materials on the light receiving and light emitting part when using.

Never apply reverse voltage (VEC) of over 6V to the photo transistor when measuring the characteristics or adjusting the system.

If applied, it causes to lower the sensitivity.

When LED has operated by voltage, it should be connected the resistor of current adjustment. Avoid to applying direct voltage to LED, because there is possibility that LED is destroyed.

When mounting, special care has to be taken on the mounting position and tilting of the device because it is very important to place the device to the optimum position to the object.

(2) Attention in designing

Avoid the entering ambient light into light receiving part for avoid the malfunction by ambient light. Furthermore, there is possibility of malfunction when there are the other mounted parts by near this product peripheral.

There will be changing characteristics by detection object. Refer to this datasheet and evaluate by actual detection object.

When LED has been applied continuous power on long period of time, the output current is dropped. If it uses by always applying power to LED, have to consider the circuit designing of including output current decrease.

■ PACKAGE OUTLINE Unit:mm

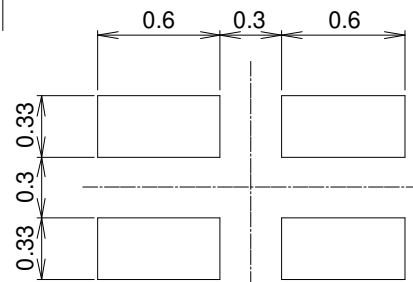
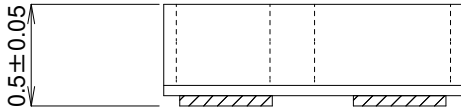
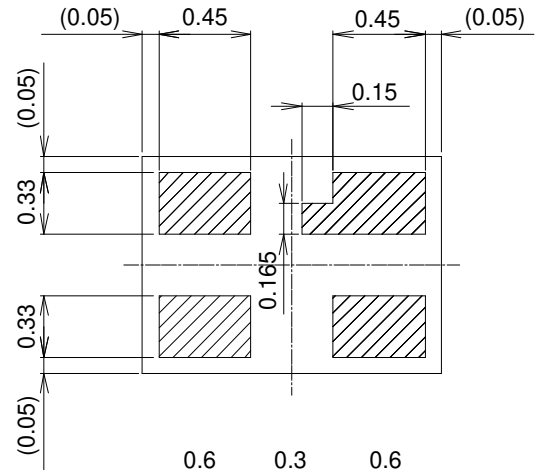
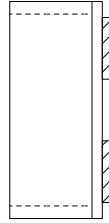
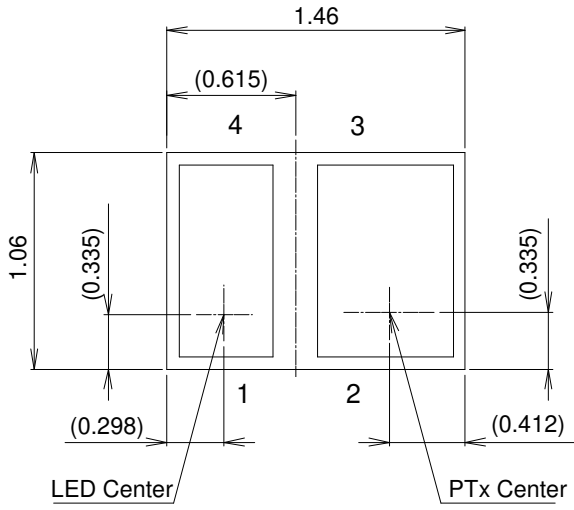

PCB Pattern

- 1. LIRA
- 2. PC
- 3. PE
- 4. LIRK

Unspecified tolerance : ±0.1mm
 Dimensions in parenthesis are shown for reference.

PACKING SPECIFICATION

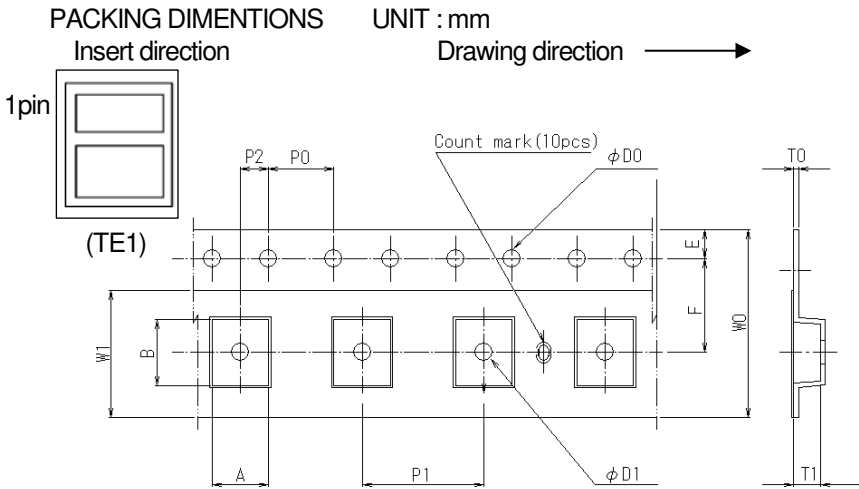

SYMBOL	DIMENSION	REMARKS
A	1.31 ±0.05	BOTTOM DIMENSION
B	1.71 ±0.05	BOTTOM DIMENSION
D0	φ1.50 +0.1/-0	
D1	φ0.50 ±0.05	
E	1.75 ±0.10	
F	3.50 ±0.05	
P0	4.00 ±0.10	
P1	4.00 ±0.10	
P2	2.00 ±0.05	
T0	0.20 ±0.05	
T1	0.67 ±0.05	
W0	8.0 +0.03/-0.1	
W1	5.4 ±0.10	THICKNESS 0.1MAX

* Carrier tape material : Polycarbonate(antistatic)
Cover tape material : PP(antistatic)

Taping Strength

Pull up the cover tape from the carrier tape, and when the opening angle comes around 10 to 15 , and the peeling-off strength is to be within the power of 20 to 70g.

Packaging

- The taped products are to be rolled up on the taping reel as on the drawing.
- Rolling up specification
 - Start rolling : Carrier tape open space more than 20 Pieces.
 - End of rolling : Carrier tape open space more than 20 Pieces, and 2 round of reel space at the cover tape only.
- Taping quantity : 2,000 Pieces
- Seal off after putting each reels in a damp proof bag with silica gel.

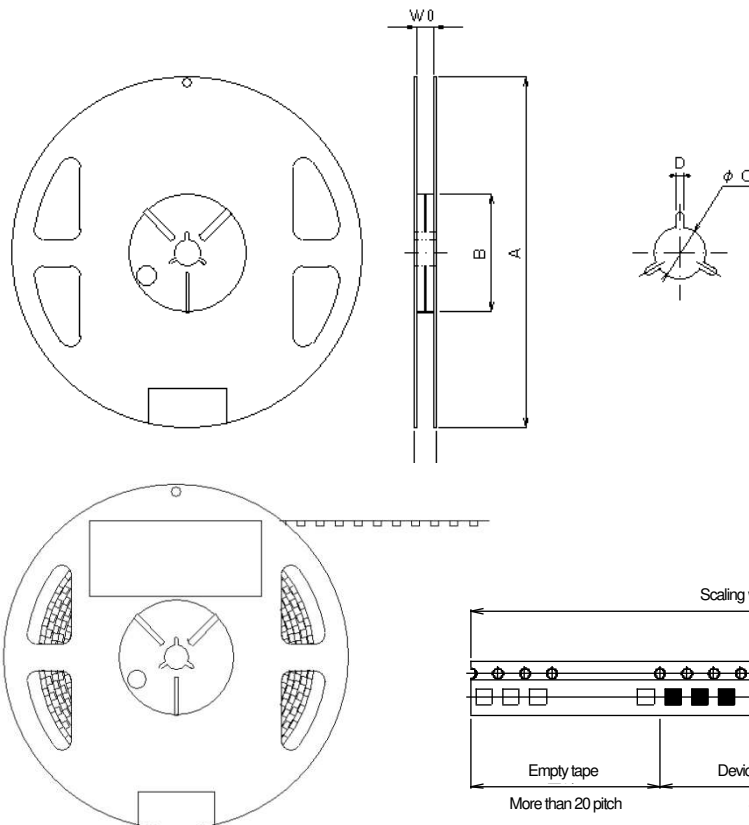

SYMBOL	DIMENSION	REMARKS
A	φ180.0 ±1.0	
B	φ60.0 ±1.0	
C	φ13.0 ±0.2	
D	2.0 ±0.5	
W0	9.0 ±1.0	INNER DIMENSION
W1	11.4 ±1.0	OUTER DIMENSION

* Reel material : PS(antistatic)

■ RECOMMENDED MOUNTING METHOD

NOTE

Mounting was evaluated with the following profiles in our company, so there was no problem.
However, confirm mounting by the condition of your company beforehand.

The exposure of device under higher temperature many affect to the reliability of the products, it is recommended to complete soldering in the shortest time possible.

Mounting: Twice soldering is allowed.

■ INFRARED REFLOW SOLDERING METHOD

Recommended reflow soldering temperature profile is in the following.

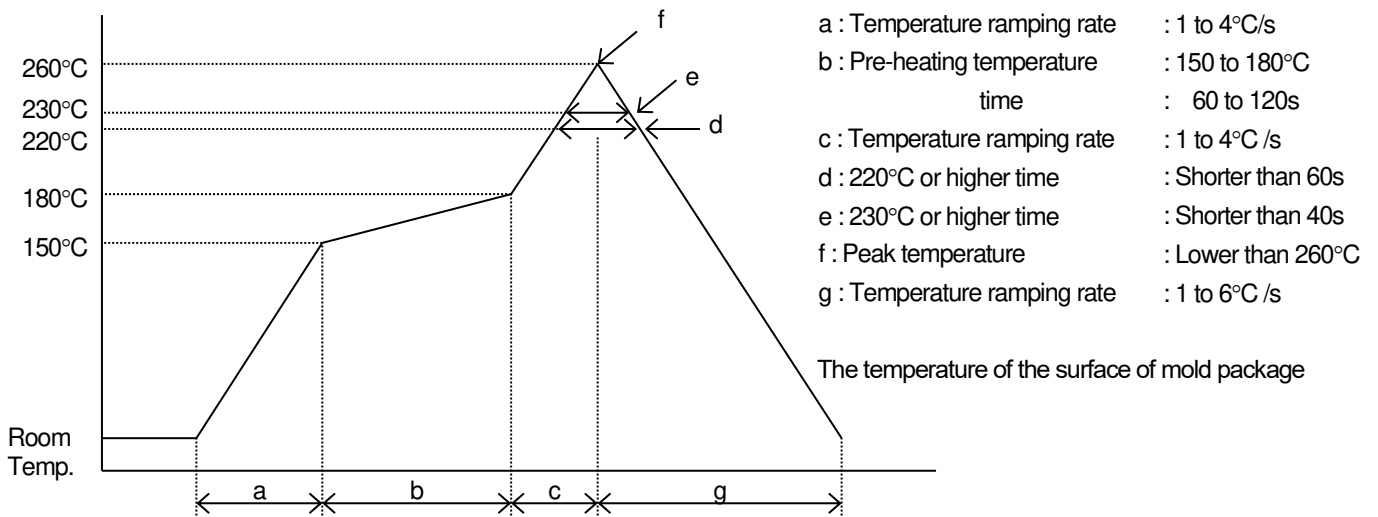

(NOTE1) Using reflow furnace with short wave infrared radiation heater such as halogen lamp

Regarding temperature profile, please refer to those fo reflow furnace.

In this case the resin surface temperature may become higher than lead terminals due to endothermic ally of black colored mold resin. Therefore, please avoid from direct exposure to mold resin.

(NOTE2) Other method

Such other methods of soldering as dipping the device into melted solder and vapor phase method (VPS) are not appropriate because the body of device will be heated rapidly. Therefore, these are not recommended to apply.

(NOTE3) The resin gets softened right after soldering, so, the following care has to be taken

Not to contact the lens surface to anything.

Not to dip the device into water or any solvents.

■ FLOE SOLDERING METHOD

Flow soldering is not possible.

■ IRON SOLDERING METHOD

Iron soldering is not possible.

■ CLEANING

Avoid washing the device after soldering by reflow method.

■ IC STORAGE CONDITIONS AND ITS DURATION**(1) Temperature and humidity ranges**

Pack Sealing	Temperature:	5 to 40 [°C]
	Humidity:	40 to 80 [%]
Pack Opening	Temperature:	5 to 30 [°C]
	Humidity:	40 to 70 [%]

After opening the bag, solder products within 48h.

Avoid a dry environment below 40% because the products are easily damageable by the electrical discharge.

Store the products in the place where it does not create dew with the products due to a sudden change in temperature.

(2) When baking, place the reel vertically to avoid load to the side.

(3) Do not store the devices in corrosive-gas atmosphere.

(4) Do not store the devices in a dusty place.

(5) Do not expose the devices to direct rays of the sun.

(6) Do not allow external forces or loads to be applied to IC's.

(7) Be careful because affixed label on the reel might be peeled off when baking.

(8) The product is recommended to do the baking before using for the stability of the quality.

■ BAKING

In case of keeping expect above condition be sure to apply baking.

Baking method: Ta=60°C, 48 to 72h, One time baking is allowed

■ STORAGE DURATION

Within a year after delivering this device.

For the products stored longer than a year, confirm their terminals and solderability before they are used.

■ MOISTURE SENSITIVITY LEVELS

JEDEC: Level 5

[CAUTION]

1. NJR strives to produce reliable and high quality semiconductors. NJR's semiconductors are intended for specific applications and require proper maintenance and handling. To enhance the performance and service of NJR's semiconductors, the devices, machinery or equipment into which they are integrated should undergo preventative maintenance and inspection at regularly scheduled intervals. Failure to properly maintain equipment and machinery incorporating these products can result in catastrophic system failures
2. The specifications on this datasheet are only given for information without any guarantee as regards either mistakes or omissions. The application circuits in this datasheet are described only to show representative usages of the product and not intended for the guarantee or permission of any right including the industrial property rights.
All other trademarks mentioned herein are the property of their respective companies.
3. To ensure the highest levels of reliability, NJR products must always be properly handled.
The introduction of external contaminants (e.g. dust, oil or cosmetics) can result in failures of semiconductor products.
4. NJR offers a variety of semiconductor products intended for particular applications. It is important that you select the proper component for your intended application. You may contact NJR's Sale's Office if you are uncertain about the products listed in this datasheet.
5. Special care is required in designing devices, machinery or equipment which demand high levels of reliability. This is particularly important when designing critical components or systems whose failure can foreseeably result in situations that could adversely affect health or safety. In designing such critical devices, equipment or machinery, careful consideration should be given to amongst other things, their safety design, fail-safe design, back-up and redundancy systems, and diffusion design.
6. The products listed in this datasheet may not be appropriate for use in certain equipment where reliability is critical or where the products may be subjected to extreme conditions. You should consult our sales office before using the products in any of the following types of equipment.
 - Aerospace Equipment
 - Equipment Used in the Deep Sea
 - Power Generator Control Equipment (Nuclear, steam, hydraulic, etc.)
 - Life Maintenance Medical Equipment
 - Fire Alarms / Intruder Detectors
 - Vehicle Control Equipment (Automobile, Airplane, railroad, ship, etc.)
 - Various Safety Devices
7. NJR's products have been designed and tested to function within controlled environmental conditions. Do not use products under conditions that deviate from methods or applications specified in this datasheet. Failure to employ the products in the proper applications can lead to deterioration, destruction or failure of the products. NJR shall not be responsible for any bodily injury, fires or accident, property damage or any consequential damages resulting from misuse or misapplication of the products. The products are sold without warranty of any kind, either express or implied, including but not limited to any implied warranty of merchantability or fitness for a particular purpose.
8. Warning for handling Gallium and Arsenic (GaAs) Products (Applying to GaAs MMIC, Photo Reflector). These products use Gallium (Ga) and Arsenic (As) which are specified as poisonous chemicals by law. For the prevention of a hazard, do not burn, destroy, or process chemically to make them as gas or power. When the product is disposed of, please follow the related regulation and do not mix this with general industrial waste or household waste.
9. The product specifications and descriptions listed in this datasheet are subject to change at any time, without notice.

