

IRS21091(S)PbF

HALF-BRIDGE DRIVER

Features

- Floating channel designed for bootstrap operation
- Fully operational to +600 V
- Tolerant to negative transient voltage, dV/dt immune
- Gate drive supply range from 10 V to 20 V
- Undervoltage lockout for both channels
- 3.3 V, 5 V, and 15 V input logic compatible
- Cross-conduction prevention logic
- Matched propagation delay for both channels
- High-side output in phase with IN input
- Logic and power ground +/- 5 V offset
- Internal 500 ns deadtime, and programmable up to 5 μ s with one external R_{DT} resistor
- Lower di/dt gate driver for better noise immunity
- The dual function DT/SD input turns off both channels
- RoHS compliant

Description

The IRS21091 is a high voltage, high speed power MOSFET and IGBT driver with dependent high- and low-side referenced output channels. Proprietary HVIC and latch immune CMOS technologies enable ruggedized monolithic construction. The logic input is compatible with standard CMOS or LSTTL output, down to 3.3 V logic. The output drivers feature a high pulse current buffer stage designed for minimum driver cross-conduction. The floating channel can be used to drive an N-channel power MOSFET or IGBT in the high-side configuration which operates up to 600 V.

Product Summary

V_{OFFSET}	600 V max.
$I_{O+/-}$	120 mA / 250 mA
V_{OUT}	10 V - 20 V
$t_{on/off}$ (typ.)	750 ns & 200 ns
Deadtime	540 ns

Packages

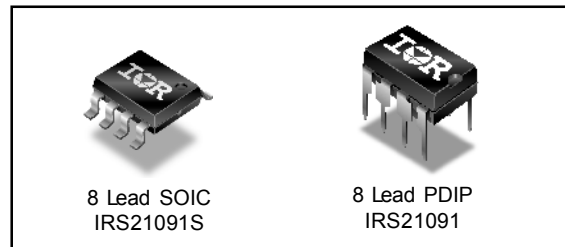

Typical Connection

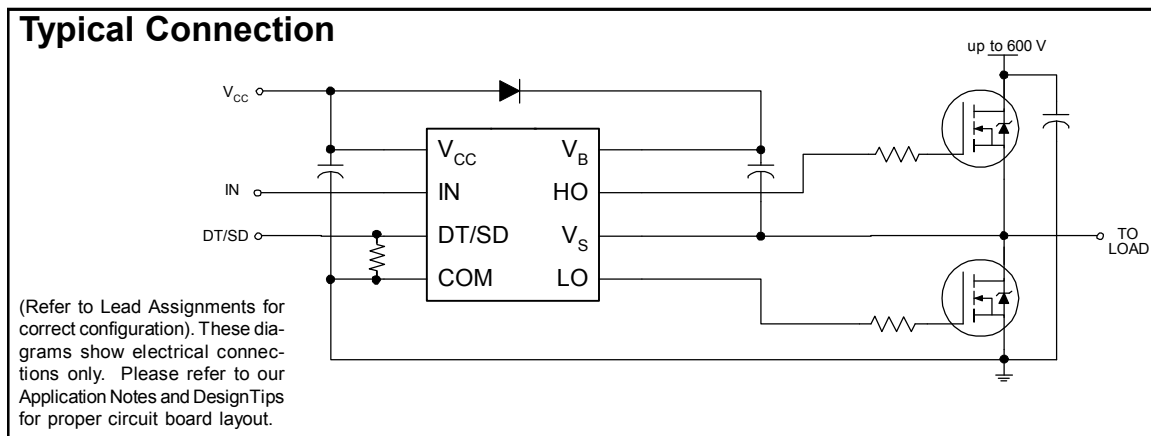

Absolute Maximum Ratings

Absolute maximum ratings indicate sustained limits beyond which damage to the device may occur. All voltage parameters are absolute voltages referenced to COM. The thermal resistance and power dissipation ratings are measured under board mounted and still air conditions.

Symbol	Definition	Min.	Max.	Units	
V _B	High-side floating absolute voltage	-0.3	625	V	
V _S	High-side floating supply offset voltage	V _B - 25	V _B + 0.3		
V _{HO}	High-side floating output voltage	V _S - 0.3	V _B + 0.3		
V _{CC}	Low-side and logic fixed supply voltage	-0.3	25		
V _{LO}	Low-side output voltage	-0.3	V _{CC} + 0.3		
DT/SD	Programmable deadtime and shutdown pin voltage	V _{SS} - 0.3	V _{CC} + 0.3		
V _{IN}	Logic input voltage (IN & DT/SD)	V _{SS} - 0.3	V _{CC} + 0.3		
dV _S /dt	Allowable offset supply voltage transient	—	50	V/ns	
P _D	Package power dissipation @ T _A ≤ +25 °C	(8 Lead PDIP)	—	1.0	W
		(8 Lead SOIC)	—	0.625	
R _{thJA}	Thermal resistance, junction to ambient	(8 Lead PDIP)	—	125	°C/W
		(8 Lead SOIC)	—	200	
T _J	Junction temperature	—	150	°C	
T _S	Storage temperature	-50	150		
T _L	Lead temperature (soldering, 10 seconds)	—	300		

Recommended Operating Conditions

The input/output logic timing diagram is shown in Fig.1. For proper operation the device should be used within the recommended conditions. The V_S offset rating is tested with all supply biased at a 15 V differential.

Symbol	Definition	Min.	Max.	Units
V_B	High-side floating supply absolute voltage	$V_S + 10$	$V_S + 20$	V
V_S	High-side floating supply offset voltage	(Note 1)	600	
V_{HO}	High-side floating output voltage	V_S	V_B	
V_{CC}	Low-side and logic fixed supply voltage	10	20	
V_{LO}	Low-side output voltage	0	V_{CC}	
V_{IN}	Logic input voltage (IN & DT/SD)	V_{SS}	V_{CC}	
DT/SD	Programmable deadtime and shutdown pin voltage	V_{SS}	V_{CC}	
T_A	Ambient temperature	-40	125	°C

Note 1: Logic operational for V_S of -5 V to +600 V. Logic state held for V_S of -5 V to $-V_{BS}$. (Please refer to the Design Tip DT97-3 for more details).

Dynamic Electrical Characteristics

$V_{BIAS} (V_{CC}, V_{BS}) = 15 \text{ V}$, $C_L = 1000 \text{ pF}$, $T_A = 25 \text{ °C}$, unless otherwise specified.

Symbol	Definition	Min.	Typ.	Max.	Units	Test Conditions
t_{on}	Turn-on propagation delay	—	750	950	ns	$V_S = 0 \text{ V}$
t_{off}	Turn-off propagation delay	—	200	280		$V_S = 0 \text{ V}$ or 600 V
t_{sd}	Shutdown propagation delay	—	550	715		$V_S = 0 \text{ V}$
MT	Delay matching, HS & LS turn-on/off	—	0	70		
t_r	Turn-on rise time	—	100	220		
t_f	Turn-off fall time	—	35	80		$R_{DT} = 0 \text{ } \Omega$
DT	Deadtime: LO turn-off to HO turn-on(DT _{LO-HO}) & HO turn-off to LO turn-on (DT _{HO-LO})	400	540	680	$R_{DT} = 200 \text{ k}\Omega$	
		4	5	6	$R_{DT} = 0 \text{ } \Omega$	
MDT	Deadtime matching = DT _{LO} - HO - DT _{HO-LO}	—	0	60	ns	$R_{DT} = 200 \text{ k}\Omega$
		—	0	600		

Static Electrical Characteristics

V_{BIAS} (V_{CC} , V_{BS}) = 15 V, and T_A = 25 °C unless otherwise specified. The V_{IL} , V_{IH} , and I_{IN} parameters are referenced to COM and are applicable to the respective input leads: IN and DT/SD. The V_O , I_O , and R_{ON} parameters are referenced to COM and are applicable to the respective output leads: HO and LO.

Symbol	Definition	Min.	Typ.	Max.	Units	Test Conditions
V_{IH}	Logic "1" input voltage for HO & logic "0" for LO	2.5	—	—	V	$V_{CC} = 10\text{ V to }20\text{ V}$
V_{IL}	Logic "0" input voltage for HO & logic "1" for LO	—	—	0.8		
$V_{SD,TH}$	DT/SD input threshold	11.5	13	14.5		
V_{OH}	High level output voltage, $V_{BIAS} - V_O$	—	0.05	0.2		
V_{OL}	Low level output voltage, V_O	—	0.02	0.1		
I_{LK}	Offset supply leakage current	—	—	50	μA	$V_B = V_S = 600\text{ V}$
I_{QBS}	Quiescent V_{BS} supply current	20	75	130		$I_N = 0\text{ V or }5\text{ V}$
I_{QCC}	Quiescent V_{CC} supply current	0.4	1.0	1.6	mA	$I_N = 0\text{ V or }5\text{ V}$ $R_{DT} = 0\ \Omega$
I_{IN+}	Logic "1" input bias current	—	5	20	μA	$I_N = 5\text{ V, DT/SD} = 0\text{ V}$
I_{IN-}	Logic "0" input bias current	—	—	5		$I_N = 0\text{ V, DT/SD} = 5\text{ V}$
V_{CCUV+} V_{BSUV+}	V_{CC} and V_{BS} supply undervoltage positive going threshold	8.0	8.9	9.8	V	
V_{CCUV-} V_{BSUV-}	V_{CC} and V_{BS} supply undervoltage negative going threshold	7.4	8.2	9.0		
V_{CCUVH} V_{BSUVH}	Hysteresis	0.3	0.7	—		
I_{O+}	Output high short circuit pulsed current	120	290	—	mA	$V_O = 0\text{ V, PW} \leq 10\ \mu\text{s}$
I_{O-}	Output low short circuit pulsed current	250	600	—		$V_O = 15\text{ V, PW} \leq 10\ \mu\text{s}$

Lead Assignments

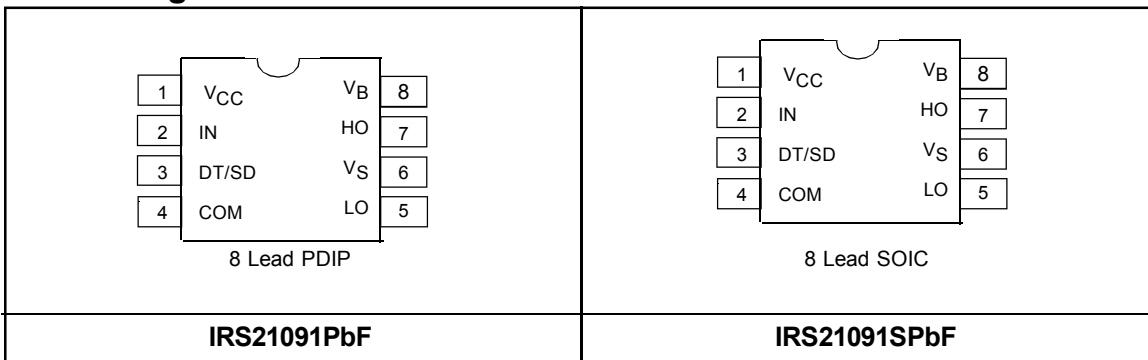

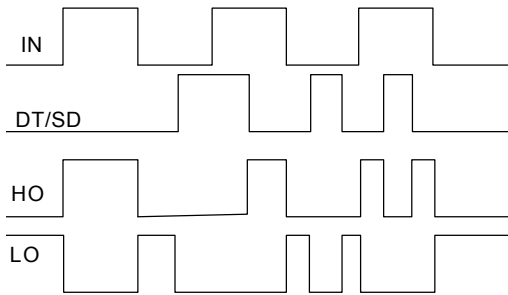

Figure 1. Input/Output Timing Diagram

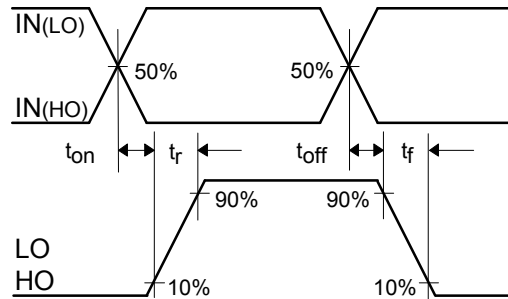

Figure 2. Switching Time Waveform Definitions

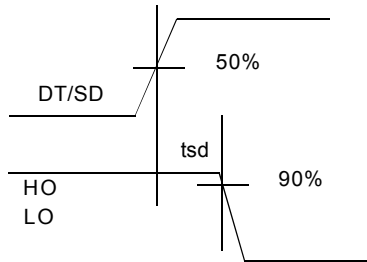

Figure 3. Shutdown Waveform Definitions

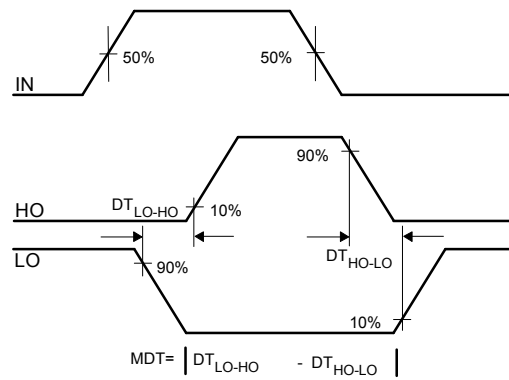

Figure 4. Deadtime Waveform Definitions

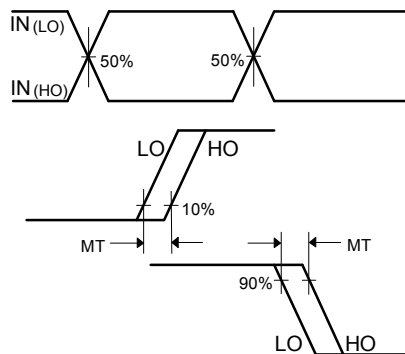

Figure 5. Delay Matching Waveform Definitions

Note: For the following figures the V_{BIAS} (V_{CC} , V_{BS}) = 15 V and $T_A = 25^\circ\text{C}$ unless otherwise specified.

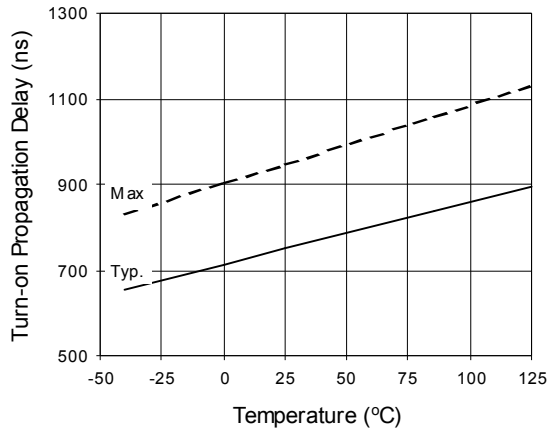

Figure 6A. Turn-On Propagation Delay vs. Temperature

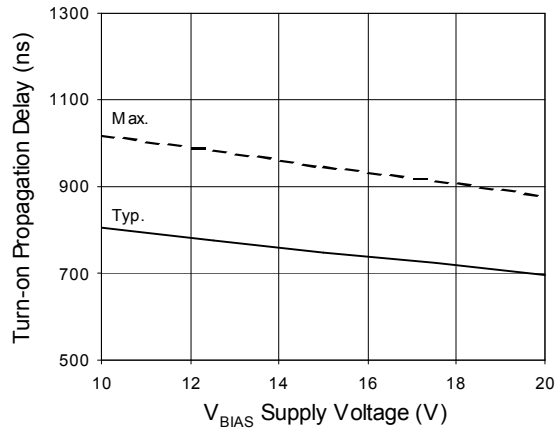

Figure 6B. Turn-On Propagation Delay vs. Supply Voltage

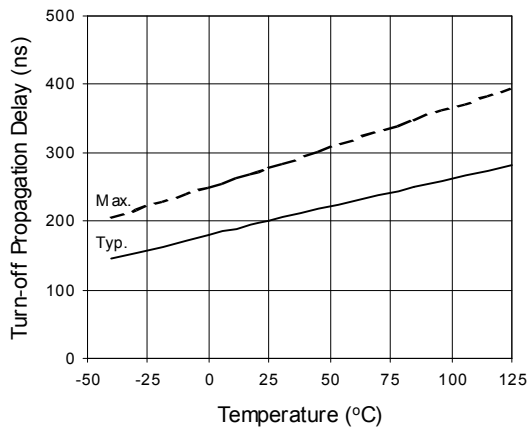

Figure 7A. Turn-Off Propagation Delay vs. Temperature

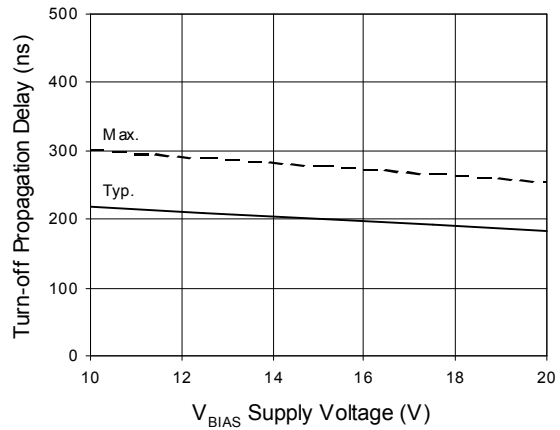

Figure 7B. Turn-Off Propagation Delay vs. Supply Voltage

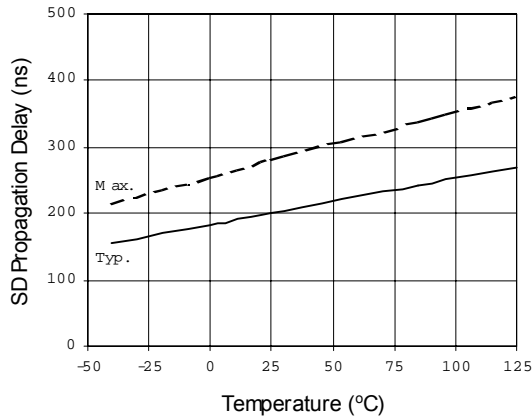

Figure 8A. SD Propagation Delay vs. Temperature

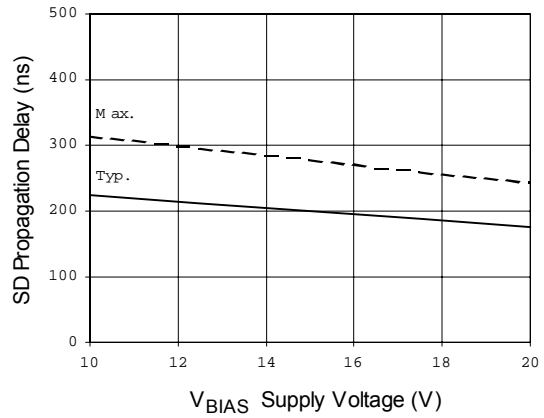

Figure 8B. SD Propagation Delay vs. Supply Voltage

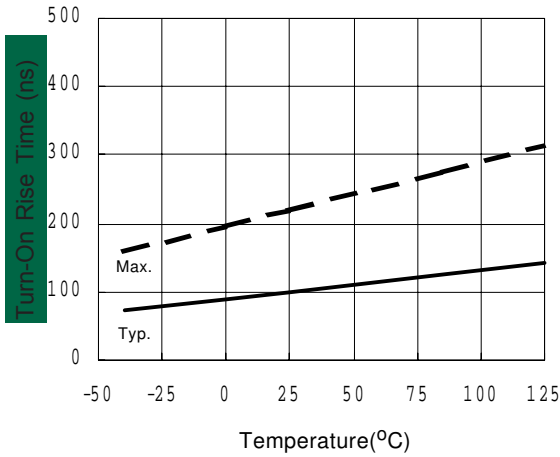

Figure 9A. Turn-On Rise Time vs. Temperature

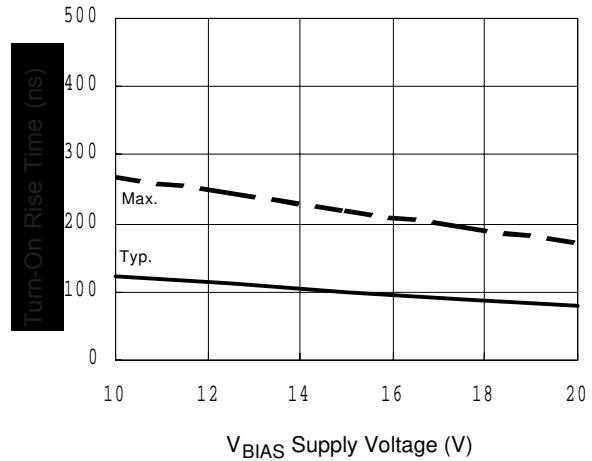

Figure 9B. Turn-On Rise Time vs. Supply Voltage

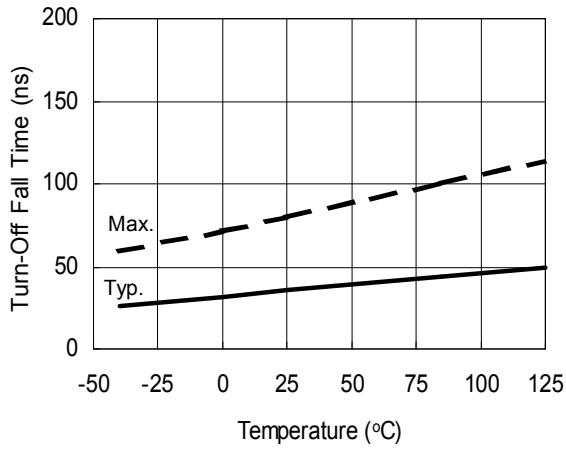

Figure 10A. Turn-Off Fall Time vs. Temperature

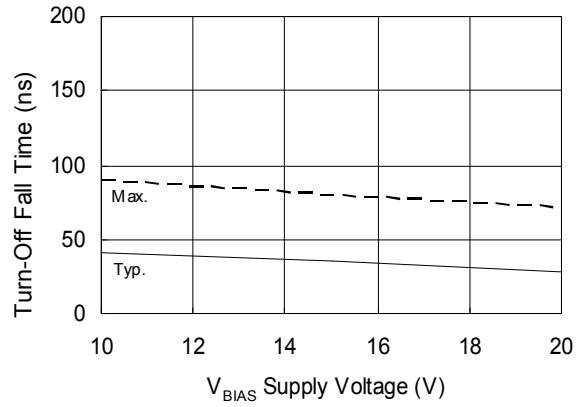

Figure 10B. Turn-Off Fall Time vs. Supply Voltage

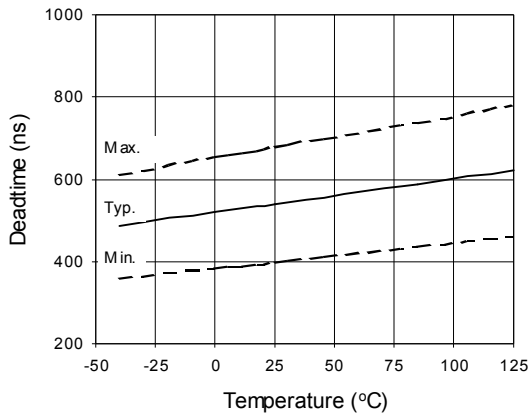

Figure 11A. Deadtime vs. Temperature

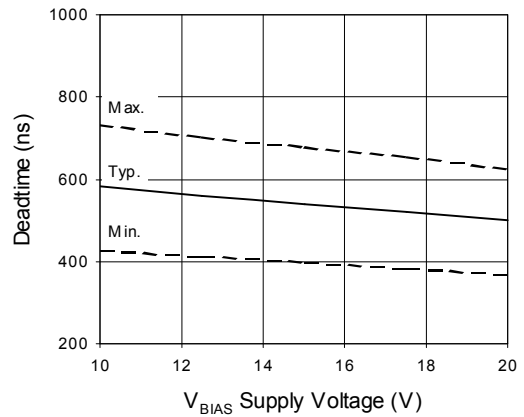

Figure 11B. Deadtime vs. Supply Voltage

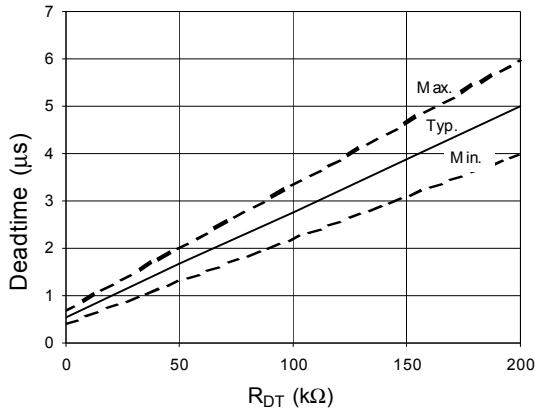

Figure 11C. Deadtime vs. R_{DT}

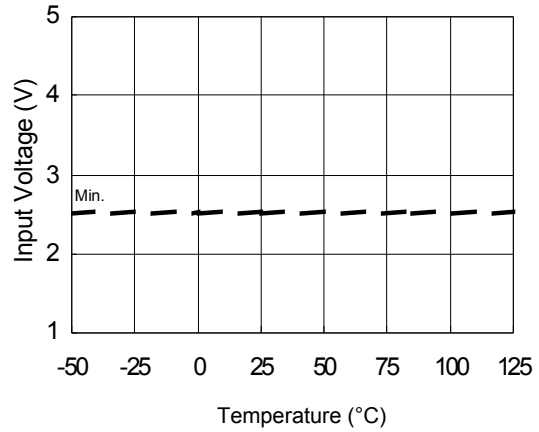

Figure 12A. Logic "1" Input Voltage vs. Temperature

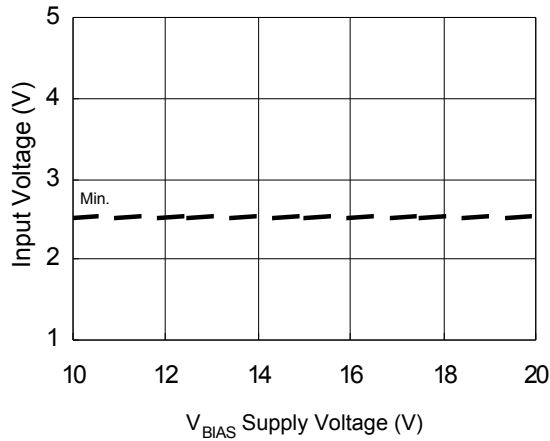

Figure 12B. Logic "1" Input Voltage vs. Supply Voltage

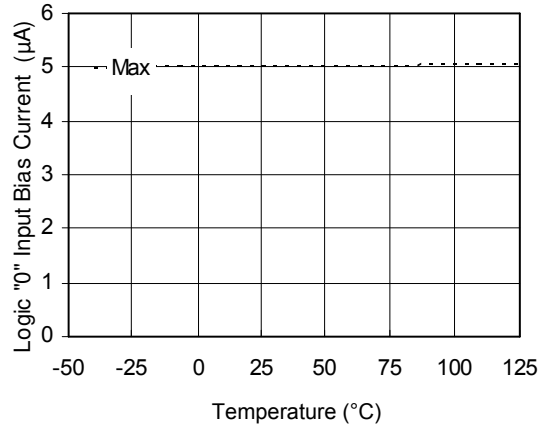

Figure 13A. Logic "0" Input Bias Current vs. Temperature

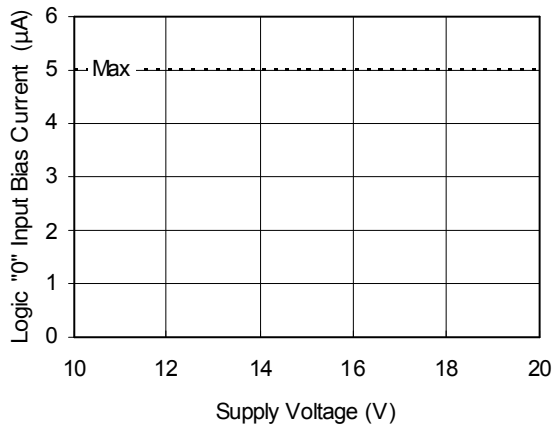

Figure 13B. Logic "0" Input Bias Current vs. Voltage

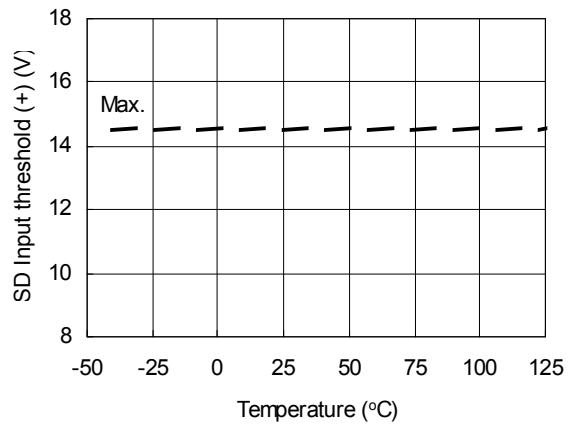

Figure 14A. SD Input Positive Going Threshold (+) vs. Temperature

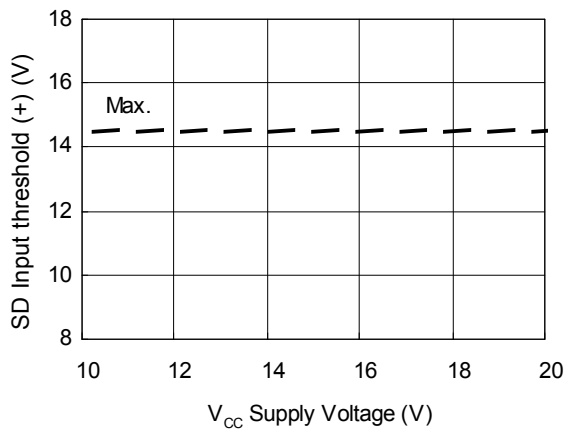

Figure 14B. SD Input Positive Going Threshold (+) vs. Supply Voltage

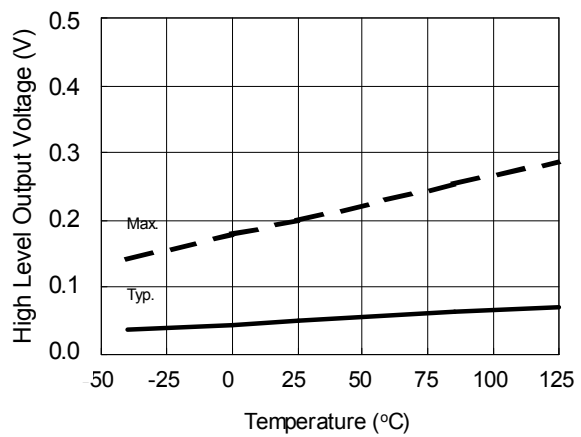

Figure 15A. High Level Output Voltage vs. Temperature

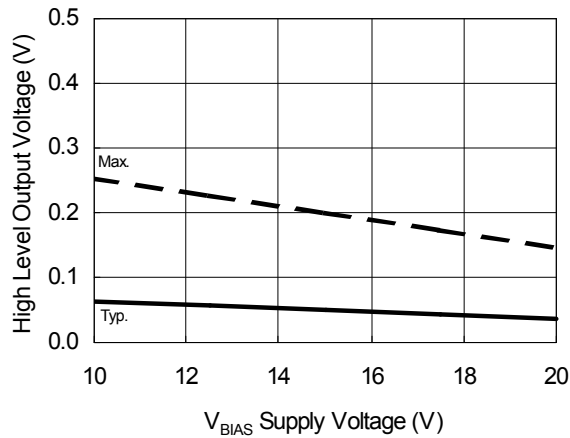

Figure 15B. High Level Output Voltage vs. Supply Voltage

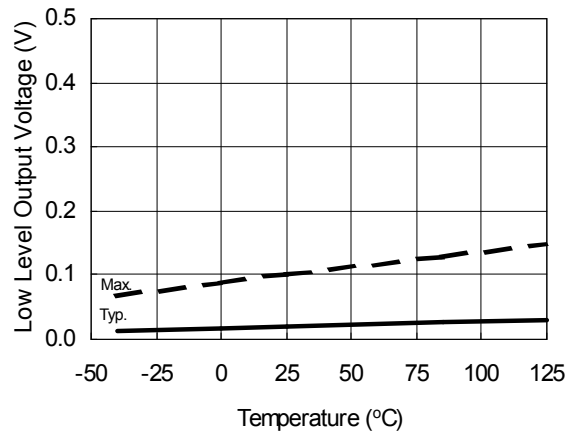

Figure 16A. Low Level Output Voltage vs. Temperature

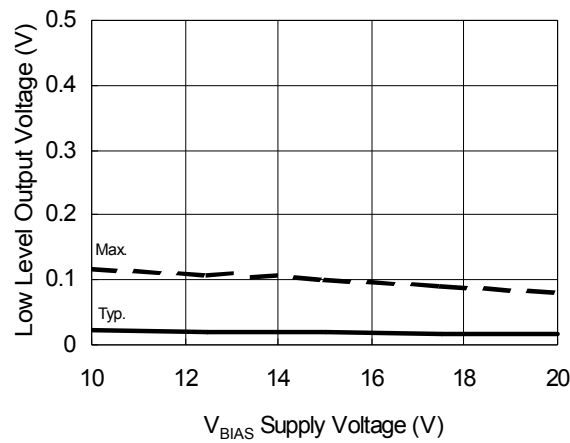

Figure 16B. Low Level Output Voltage vs. Supply Voltage

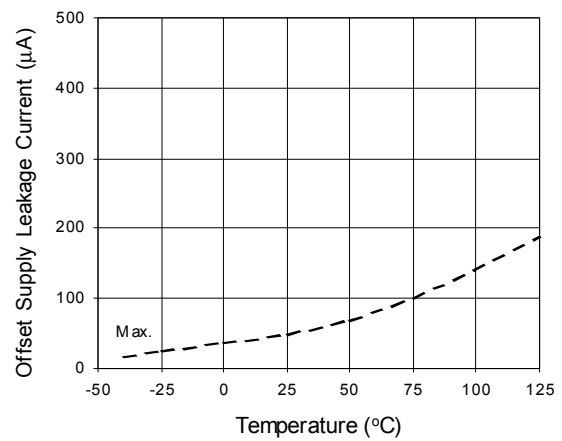

Figure 17A. Offset Supply Leakage Current vs. Temperature

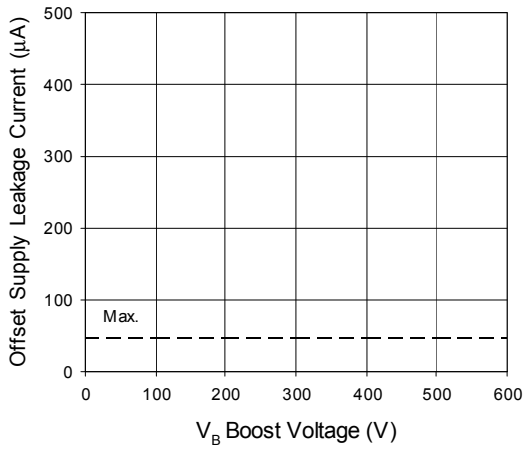

Figure 17B. Offset Supply Leakage Current vs. Boost Voltage

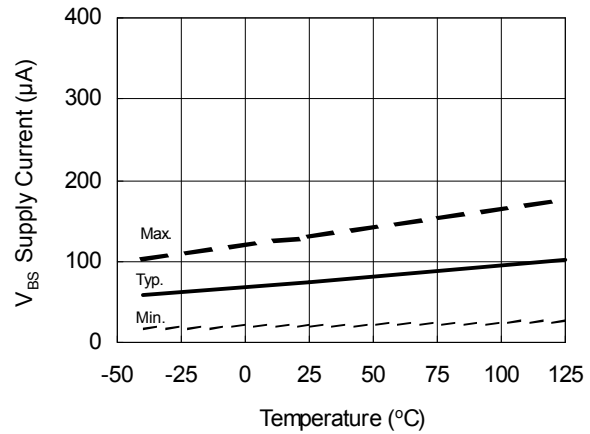

Figure 18A. V_{BS} Supply Current vs. Temperature

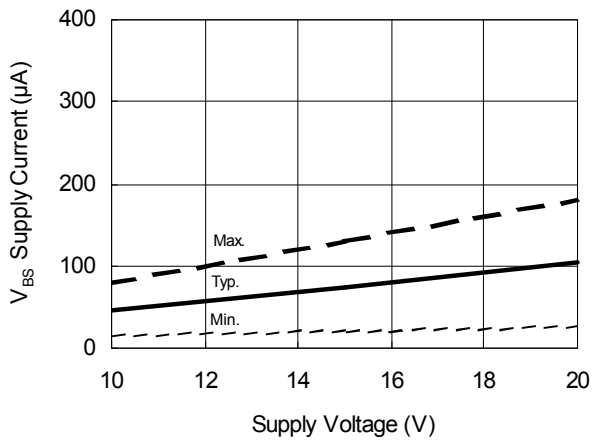

Figure 18B. V_{BS} Supply Current vs. Supply Voltage

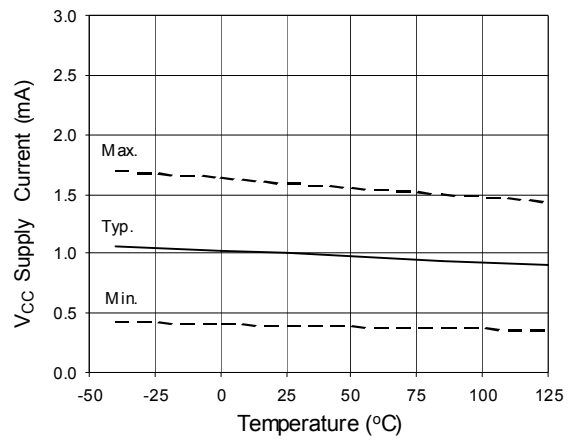

Figure 19A. V_{CC} Supply Current vs. Temperature

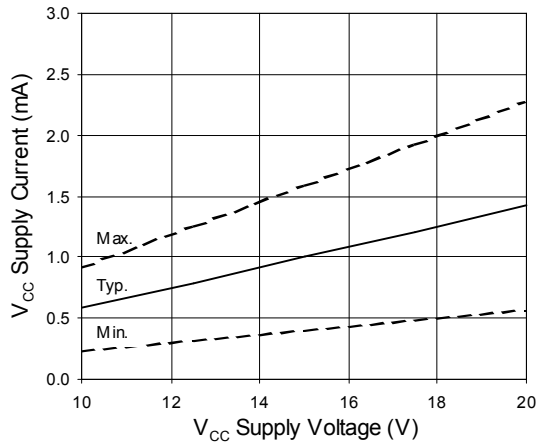

Figure 19B. V_{CC} Supply Current vs. V_{CC} Supply Voltage

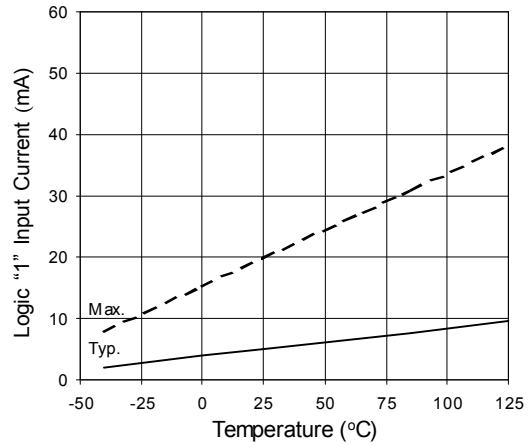

Figure 20A. Logic "1" Input Current vs. Temperature

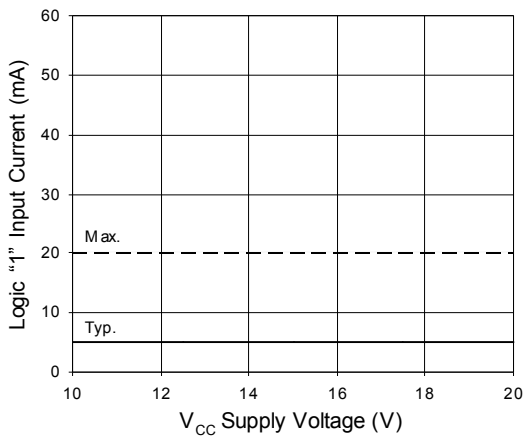

Figure 20B. Logic "1" Input Current vs. Supply Voltage

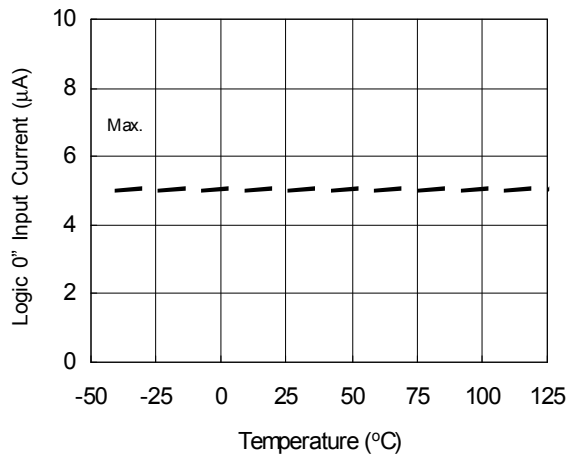

Figure 21A. Logic "0" Input Current vs. Temperature

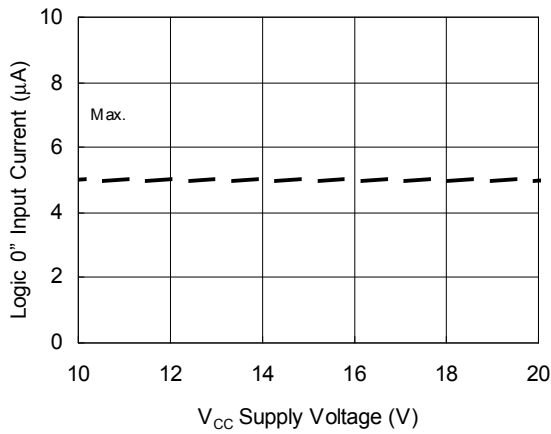

Figure 21B. Logic "0" Input Current vs. Supply Voltage

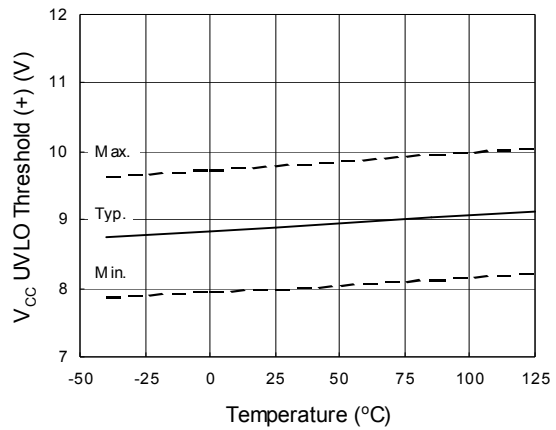

Figure 22. V_{CC} Undervoltage Threshold (+) vs. Temperature

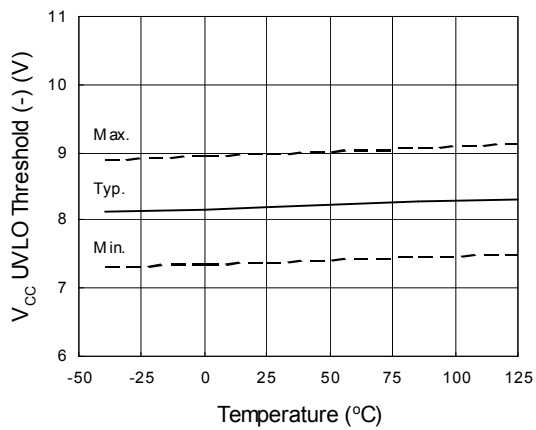

Figure 23. V_{CC} Undervoltage Threshold (-) vs. Temperature

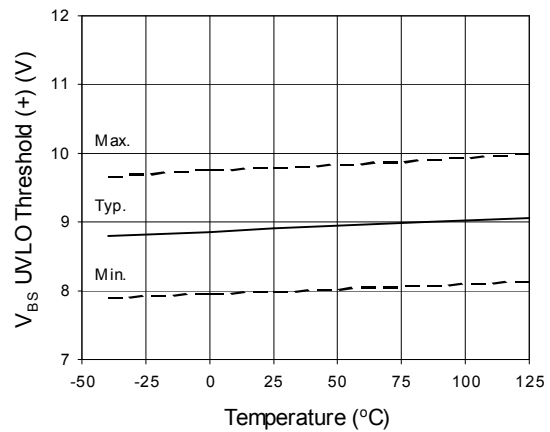

Figure 24. V_{BS} Undervoltage Threshold (+) vs. Temperature

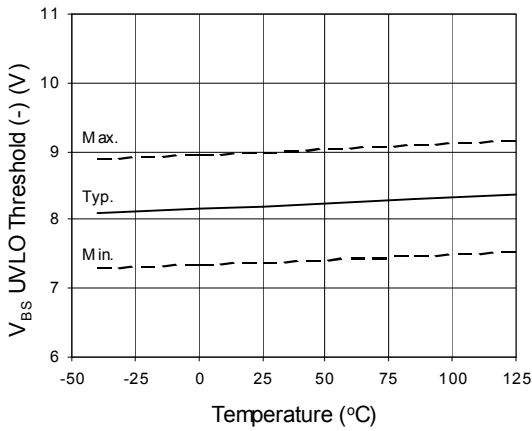

Figure 25. V_{BS} Undervoltage Threshold (-) vs. Temperature

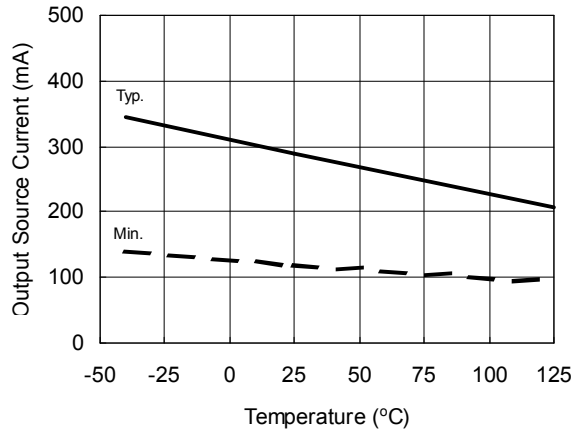

Figure 26A. Output Source Current vs. Temperature

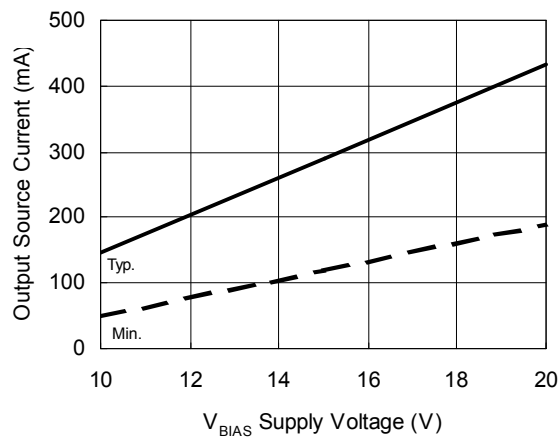

Figure 26B. Output Source Current vs. Supply Voltage

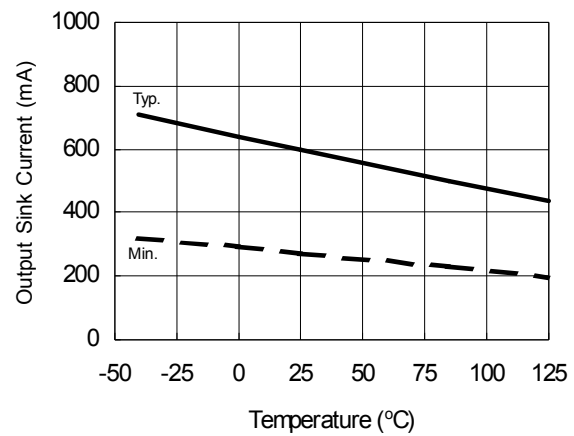

Figure 27A. Output Sink Current vs. Temperature

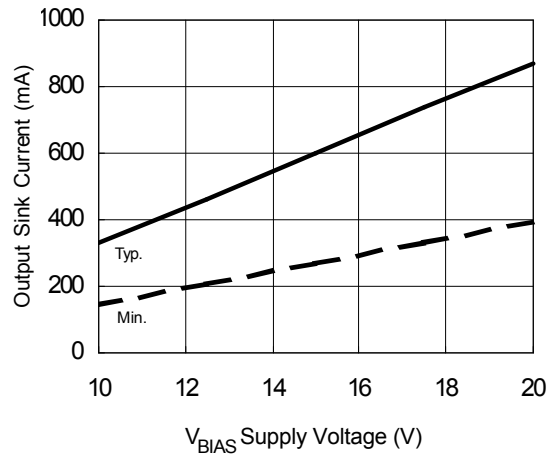

Figure 27B. Output Sink Current vs. Supply Voltage

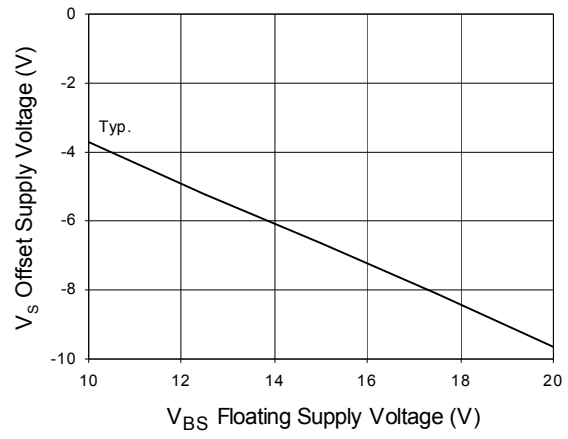
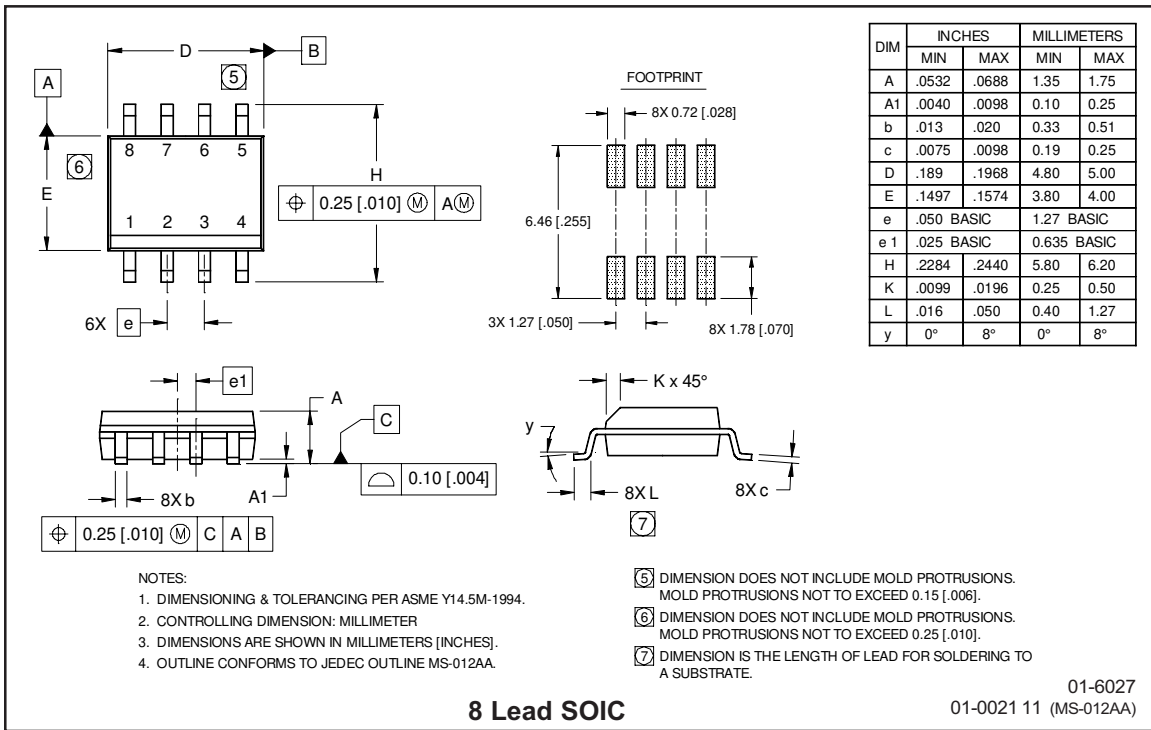
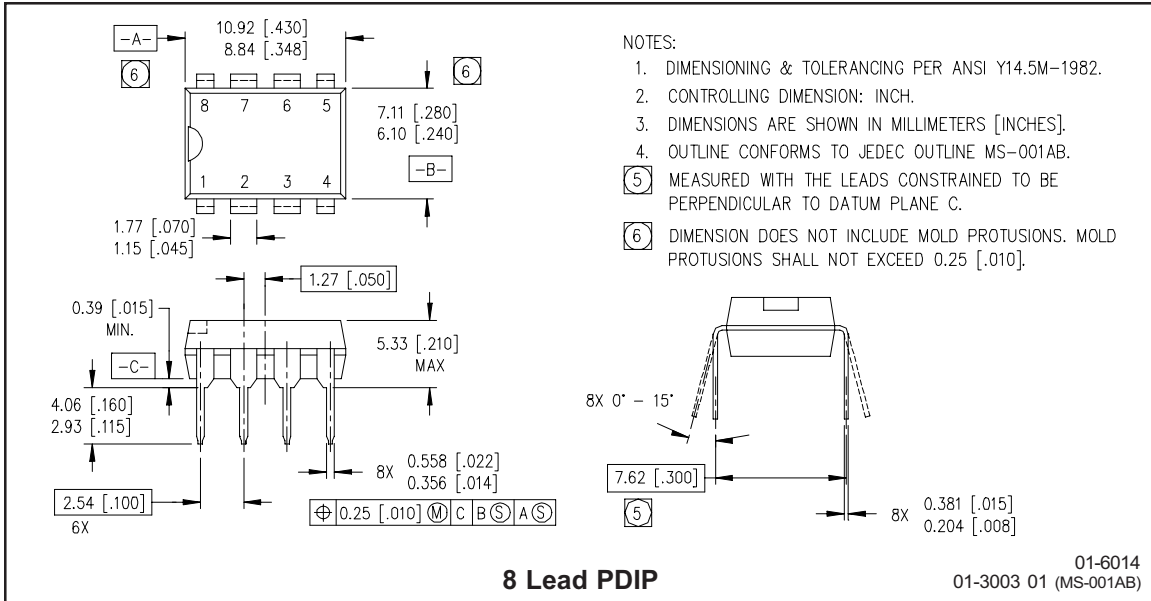
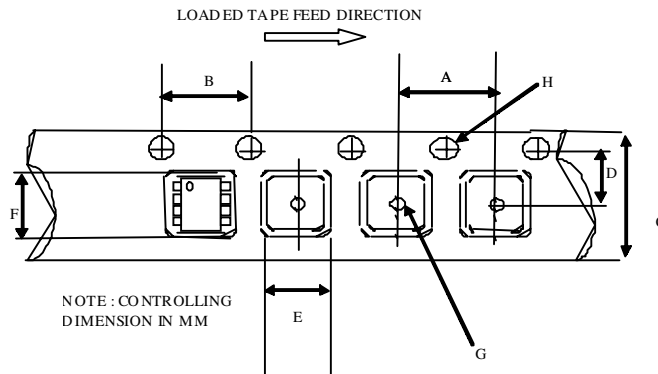

Figure 28. Maximum V_S Negative Offset vs. Supply Voltage

Case Outlines



Tape & Reel 8-lead SOIC



CARRIER TAPE DIMENSION FOR 8SOICN

Code	Metric		Imperial	
	Min	Max	Min	Max
A	7.90	8.10	0.311	0.318
B	3.90	4.10	0.153	0.161
C	11.70	12.30	0.46	0.484
D	5.45	5.55	0.214	0.218
E	6.30	6.50	0.248	0.255
F	5.10	5.30	0.200	0.208
G	1.50	n/a	0.059	n/a
H	1.50	1.60	0.059	0.062

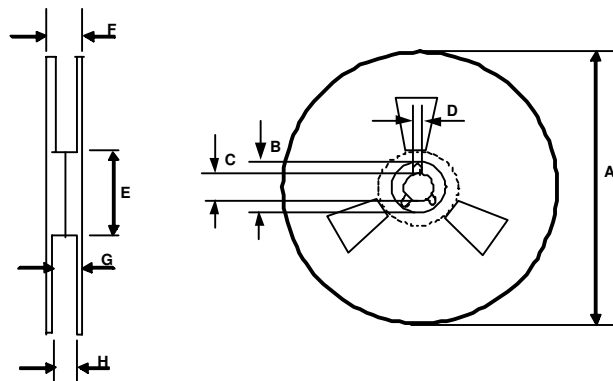

REEL DIMENSIONS FOR 8SOICN

Code	Metric		Imperial	
	Min	Max	Min	Max
A	329.60	330.25	12.976	13.001
B	20.95	21.45	0.824	0.844
C	12.80	13.20	0.503	0.519
D	1.95	2.45	0.767	0.096
E	98.00	102.00	3.858	4.015
F	n/a	18.40	n/a	0.724
G	14.50	17.10	0.570	0.673
H	12.40	14.40	0.488	0.566

LEADFREE PART MARKING INFORMATION

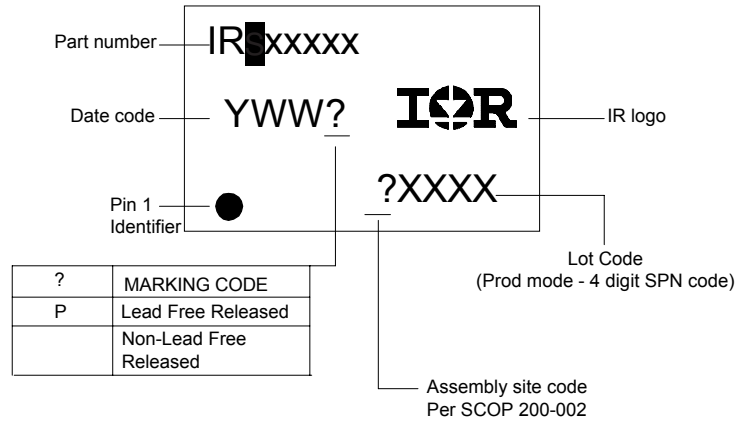

ORDER INFORMATION

- 8-Lead PDIP IRS21091PbF
- 8-Lead SOIC IRS21091SPbF
- 8-Lead SOIC Tape & Reel IRS21091STRPbF