

REF -50 OPTION SCREW  
(WHERE APPLICABLE)

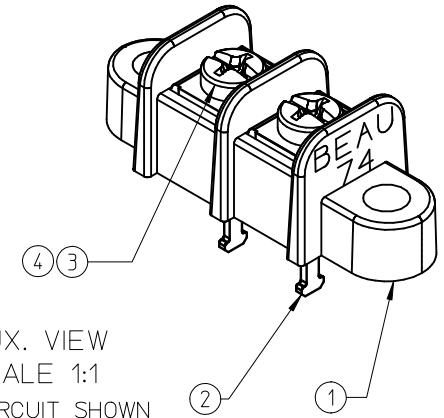

AUX. VIEW  
SCALE 1:1  
2 CIRCUIT SHOWN

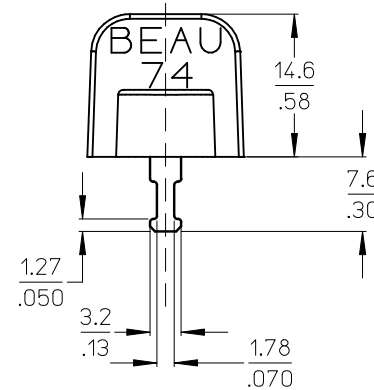
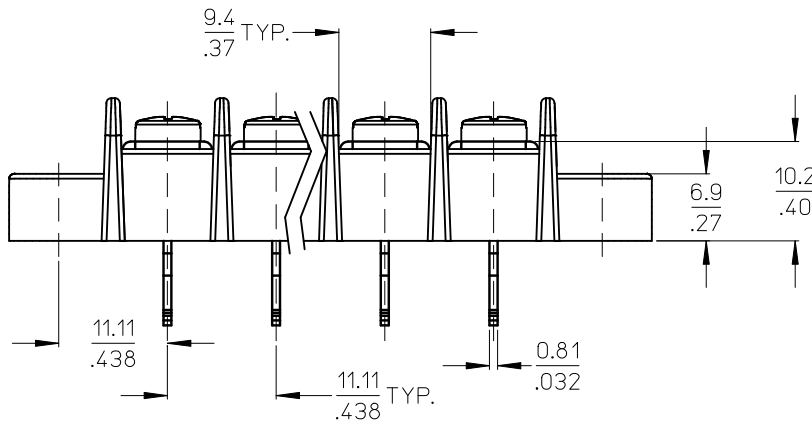

NOTES:

1. MATERIAL: SEE TABLE
2. FINISHES: SEE TABLE
3. PRODUCT SPECIFICATION: AS REQUIRED
4. "XX" REFERS TO THE NUMBER OF CIRCUITS
5. ROHS COMPLIANT

ITEM	QTY	DESCRIPTION	MATERIAL	FINISH
5	"XX"	SCREW #6-32X.250 PAN HD W/WSHR (-50 OPTION)	STEEL	ZN, CLEAR CHROMATE
4	"XX"	SCREW #6-32X.250 BDG HD (-49 OPTION)	BRASS	NICKEL PLATE
3	"XX"	SCREW #6-32X.250 BDG HD (STANDARD)	STEEL	ZN, CLEAR CHROMATE
2	"XX"	TERMINAL TURRET 6C SN/B	BRASS	TIN PLATE
1	1	SR BTS INSULATOR MO MTG	POLYESTER (PBT)	BLACK

RELEASED  
EC NO: WNA2011-0364  
DRAWN: JENC INAS 2010/09/10  
CHKD: JENC INAS  
APPR: JMACNEIL 2011/04/08  
DESCRIPTION  
REV A

QUALITY SYMBOLS  
▽=0  
▽/▽=0

GENERAL TOLERANCES (UNLESS SPECIFIED)

	mm	INCH
4 PLACES	± ---	± ---
3 PLACES	± ---	± .005
2 PLACES	± 0.13	± .01
1 PLACE	± 0.3	± ---

ANGULAR ± 2°

DRAFT WHERE APPLICABLE  
MUST REMAIN  
WITHIN DIMENSIONS

DIMENSION STYLE  
MM/IN

DRAWN BY  
JENC INAS

CHECKED BY  
CLYORK

APPROVED BY  
JMACNEIL

MATERIAL NO.

DATE  
2010/09/09  
2010/09/09  
2011/04/08

SCALE  
2:1

DESIGN UNITS  
INCH

THIRD ANGLE PROJECTION

TITLE  
11.1MM/.438" SR BTS  
TURRET TAIL ASSY  
(746XX)

MOLEX INCORPORATED

DOCUMENT NO.  
SD-38740-007

SHEET NO.  
1 OF 2

THIS DRAWING CONTAINS INFORMATION THAT IS PROPRIETARY TO MOLEX INCORPORATED AND SHOULD NOT BE USED WITHOUT WRITTEN PERMISSION

NO. OF CIRCUITS "XX"	DIM. "A"		DIM. "B"		DIM. "C"		DIM. "D"		ASSEMBLY MATERIAL No. STANDARD	ASSEMBLY MATERIAL No. -49 OPT.	ASSEMBLY MATERIAL No. -50 OPT.
	MM	INCH	MM	INCH	MM	INCH	MM	INCH			
2	43.5	1.71	11.1	0.44	24.6	0.97	33.3	1.31	387409102	387409702	387410302
3	54.6	2.15	22.2	0.88	35.7	1.40	44.5	1.75	387409103	387409703	387410303
4	65.7	2.59	33.3	1.31	46.8	1.84	55.6	2.19	387409104	387409704	387410304
5	76.8	3.02	44.4	1.75	57.9	2.28	66.7	2.63	387409105	387409705	387410305
6	88.0	3.46	55.6	2.19	69.0	2.72	77.8	3.06	387409106	387409706	387410306
7	99.1	3.90	66.7	2.63	80.1	3.15	88.9	3.50	387409107	387409707	387410307
8	110.2	4.34	77.8	3.06	91.2	3.59	100.0	3.94	387409108	387409708	387410308
9	121.3	4.77	88.9	3.50	102.3	4.03	111.1	4.38	387409109	387409709	387410309
10	132.4	5.21	100.0	3.94	113.5	4.47	122.2	4.81	387409110	387409710	387410310
11	143.5	5.65	111.1	4.38	124.6	4.90	133.4	5.25	387409111	387409711	387410311
12	154.6	6.09	122.2	4.81	135.7	5.34	144.5	5.69	387409112	387409712	387410312
13	165.7	6.52	133.4	5.25	146.8	5.78	155.6	6.13	387409113	387409713	387410313
14	176.9	6.96	144.5	5.69	157.9	6.22	166.7	6.56	387409114	387409714	387410314
15	188.0	7.40	155.6	6.13	169.0	6.65	177.8	7.00	387409115	387409715	387410315
16	199.1	7.84	166.7	6.56	180.1	7.09	188.9	7.44	387409116	387409716	387410316
17	210.2	8.27	177.8	7.00	191.2	7.53	200.0	7.88	387409117	387409717	387410317
18	221.3	8.71	188.9	7.44	202.3	7.97	211.1	8.31	387409118	387409718	387410318
19	232.4	9.15	200.0	7.88	213.4	8.40	222.3	8.75	387409119	387409719	387410319
20	243.5	9.59	211.1	8.31	224.6	8.84	233.4	9.19	387409120	387409720	387410320
21	254.6	10.02	222.3	8.75	235.7	9.28	244.5	9.63	387409121	387409721	387410321
22	265.8	10.46	233.4	9.19	246.8	9.72	255.6	10.06	387409122	387409722	387410322
23	276.9	10.90	244.5	9.63	257.9	10.15	266.7	10.50	387409123	387409723	387410323
24	288.0	11.34	255.6	10.06	269.0	10.59	277.8	10.94	387409124	387409724	387410324
25	299.1	11.77	266.7	10.50	280.1	11.03	288.9	11.38	387409125	387409725	387410325
26	310.2	12.21	277.8	10.94	291.2	11.47	300.1	11.81	387409126	387409726	387410326
27	321.3	12.65	288.9	11.38	302.3	11.90	311.2	12.25	387409127	387409727	387410327
28	332.4	13.09	300.0	11.81	313.4	12.34	322.3	12.69	387409128	387409728	387410328
29	343.5	13.52	311.2	12.25	324.5	12.78	333.4	13.13	387409129	387409729	387410329
30	354.7	13.96	322.3	12.69	335.7	13.22	344.5	13.56	387409130	387409730	387410330

RELEASED EC NO: WNA2011-0364 DRWN: JENCINAS 2010/09/10 CHKD: APPR: JMACNEIL 2011/04/08 REV A	QUALITY SYMBOLS ▽=0 ▽=0	GENERAL TOLERANCES (UNLESS SPECIFIED) mm INCH 4 PLACES ± --- ± --- 3 PLACES ± --- ± .005 2 PLACES ± 0.13 ± .01 1 PLACE ± 0.3 ± --- ANGULAR ± 2 °	DIMENSION STYLE MM/IN DRAWN BY DATE JENCINAS 2010/09/09 CHECKED BY DATE CLYORK 2010/09/09 APPROVED BY DATE JMACNEIL 2011/04/08	SCALE 2:1 DESIGN UNITS INCH THIRD ANGLE PROJECTION	TITLE 11.1MM/.438" SR BTS TURRET TAIL ASSY (746XX)	MOLEX INCORPORATED DOCUMENT NO. SD-38740-007 SHEET NO. 2 OF 2
	DRAFT WHERE APPLICABLE MUST REMAIN WITHIN DIMENSIONS		SEE CHART	THIS DRAWING CONTAINS INFORMATION THAT IS PROPRIETARY TO MOLEX INCORPORATED AND SHOULD NOT BE USED WITHOUT WRITTEN PERMISSION		