

167024-1 ✓ ACTIVE

AMPMODU | AMPMODU IV/V

TE Internal #: 167024-1

Connector Contact, Socket, Wire-to-Board, 32 – 28 AWG Wire Size, 59.2 – 177.62 CMA Wire Size, .03 – .09 mm² Wire Size, Gold, Loose Piece, AMPMODU IV/V

[View on TE.com >](#)



Connectors > PCB Connectors > Wire-to-Board Connectors > Wire-to-Board Connector Contacts

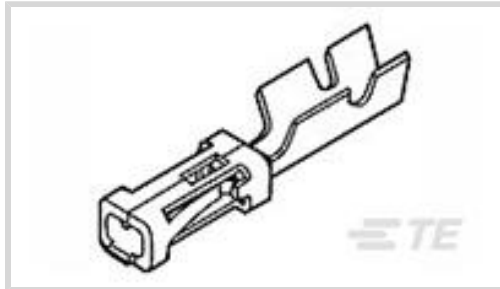

Contact Type: **Socket**

Connector System: **Wire-to-Board**

Wire Size: **.03 – .09 mm²**

Features

Product Type Features

Applied Pressure	Intermediate
Connector System	Wire-to-Board
Connector & Contact Terminates To	Wire & Cable

Configuration Features

Compatible With Wire & Cable Type	Discrete Wire
-----------------------------------	---------------

Contact Features

Mating Square Post Dimension	.64 mm[.025 in]
Wire Contact Termination Area Plating Thickness	.5 μm
Wire Contact Termination Area Plating Material	Tin
	30 μin
Contact Base Material	Phosphor Bronze
Contact Type	Socket
Contact Mating Area Plating Material	Gold
Contact Current Rating (Max)	3 A

Termination Features

Termination Method to Wire & Cable	Crimp
------------------------------------	-------

Mechanical Attachment

Wire Insulation Support	With
-------------------------	------

Dimensions



Compatible Insulation Diameter Range	1.2 mm[.047 in]
--------------------------------------	-----------------

Wire Size	.03 – .09 mm ²
-----------	---------------------------

Usage Conditions

Operating Temperature Range	-65 – 105 °C[-85 – 221 °F]
-----------------------------	----------------------------

Operation/Application

Circuit Application	Power & Signal
---------------------	----------------

Packaging Features

Packaging Quantity	200
--------------------	-----

Packaging Method	Loose Piece
------------------	-------------

Other

Connector Contacts Comment	For 0.63 mm "Round" Post and 0.63 x 0.63 mm "Square" Post.
----------------------------	--

Product Compliance

[For compliance documentation, visit the product page on TE.com>](#)

EU RoHS Directive 2011/65/EU	Compliant
------------------------------	-----------

EU ELV Directive 2000/53/EC	Compliant
-----------------------------	-----------

China RoHS 2 Directive MIIT Order No 32, 2016	No Restricted Materials Above Threshold
---	---

EU REACH Regulation (EC) No. 1907/2006	Current ECHA Candidate List: JUNE 2023 (235) Candidate List Declared Against: JUNE 2023 (235) Does not contain REACH SVHC
--	---

Halogen Content	Low Halogen - Br, Cl, F, I < 900 ppm per homogenous material. Also BFR/CFR/PVC Free
-----------------	---

Solder Process Capability	Not applicable for solder process capability
---------------------------	--

Product Compliance Disclaimer

This information is provided based on reasonable inquiry of our suppliers and represents our current actual knowledge based on the information they provided. This information is subject to change. The part numbers that TE has identified as EU RoHS compliant have a maximum concentration of 0.1% by weight in homogenous materials for lead, hexavalent chromium, mercury, PBB, PBDE, DBP, BBP, DEHP, DIBP, and 0.01% for cadmium, or qualify for an exemption to these limits as defined in the Annexes of Directive 2011/65/EU (RoHS2). Finished electrical and electronic equipment products will be CE marked as required by Directive 2011/65/EU. Components may not be CE marked. Additionally, the part numbers that TE has identified as EU ELV compliant have a maximum concentration of 0.1% by weight in homogenous materials for lead, hexavalent chromium, and mercury, and 0.01% for cadmium, or qualify for an exemption to these limits as defined in the Annexes of Directive 2000/53/EC (ELV). Regarding the REACH Regulation, the information TE provides on SVHC in articles for this part number is based on the latest European Chemicals Agency (ECHA) 'Guidance on requirements for substances in articles' posted at this URL: <https://echa.europa.eu/guidance-documents/guidance-on-reach>

Compatible Parts



TE Part # 925370-5
MOD IV REC HSG 2X5P.



TE Part # 925366-8
MOD 4 REC.HSG 1X08P



TE Part # 926476-3
MOD 4 HSG



TE Part # 925370-6
MOD.IV REC HSG, 2X6P



TE Part # 926476-8
MOD 4 HSG



TE Part # 925369-4
MOD IV HSG



TE Part # 926475-3
03P MODU 4 HSG.S.R.



TE Part # 926475-4
MOD 4 HSG



TE Part # 925369-3
MOD 4 REC.HSG 1X03P



TE Part # 925369-6
MOD 4 REC.HSG 1X06P



TE Part # 925370-2
MOD IV REC HSG, 2X2P



TE Part # 925369-2
MOD 4 REC.HSG 1X02P

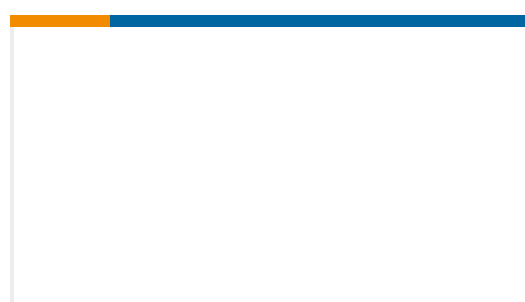

TE Part # 925366-2
MOD 4 REC.HSG 1X02P



TE Part # 925370-4
MOD IV REC HSG 2X4 POS



TE Part # 925367-4
MOD 4 REC.HSG 2X04P



TE Part # 925369-5
MOD 4 REC.HSG 1X05P



TE Part # 925370-3
MOD IV REC HSG, 2X3P



TE Part # 926476-6
MOD 4 HSG



TE Part # 1-925366-0
MOD 4 REC.HSG 1X10P



TE Part # 5-925370-0
MOD IV REC HSG, 2X50P

Also in the Series | **AMPMODU IV/V**



Automotive Housings(2)

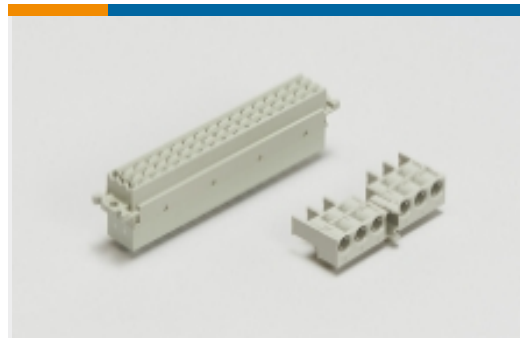

Backplane Connector Housings(1)



Board-to-Board Connector Contacts(6)



Connector Strain Relief(3)



Insertion & Extraction Tools(4)

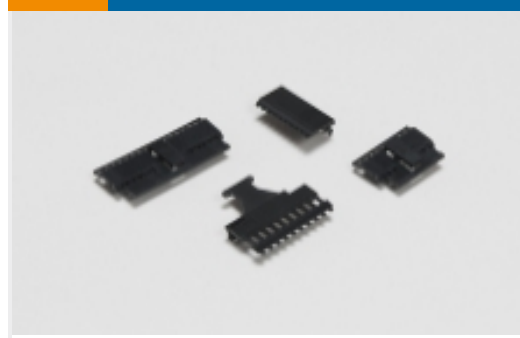

PCB Connector Covers(18)



PCB Connector Keying(6)



PCB Connector Mounting(1)

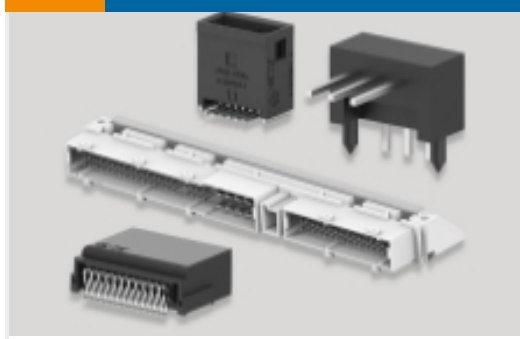

PCB Headers & Receptacles(934)

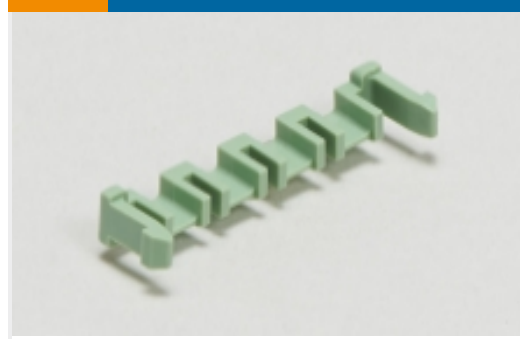

PCB Latches, Locks & Retainers(7)



Rectangular Connector Housings(5)



Standard Rectangular Connectors(8)



Wire-to-Board Connector Assemblies & Housings(447)



Wire-to-Board Connector Contacts (322)

Customers Also Bought



TE Part #640454-7
07P MTA100 HDR ASSY SQ STR POL

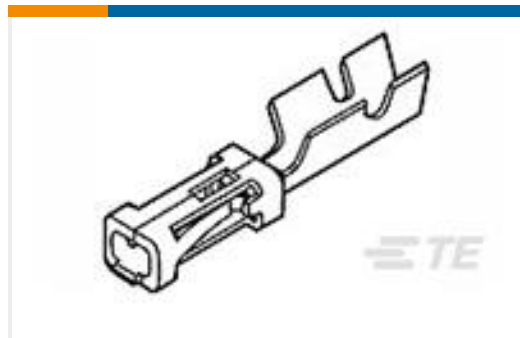

TE Part #141708-1
MOD-4 REC.CONT.SCP.



TE Part #5-1768016-4
BKM-3823-9

Documents



Product Drawings

[MOD-4 REC.CONT.SCP.](#)

English

CAD Files

Customer View Model

[ENG_CVM_167024-1_A.3d_igs.zip](#)

English

Customer View Model

[ENG_CVM_167024-1_A.3d_stp.zip](#)

English

Customer View Model

[ENG_CVM_167024-1_A.2d_dxf.zip](#)

English

[3D PDF](#)

English

By downloading the CAD file I accept and agree to the [Terms and Conditions](#) of use.

Product Environmental Compliance

[TE Material Declaration](#)

English