

1

2

3

4

5

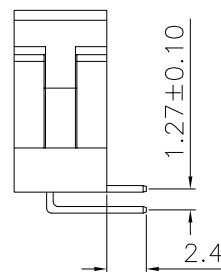
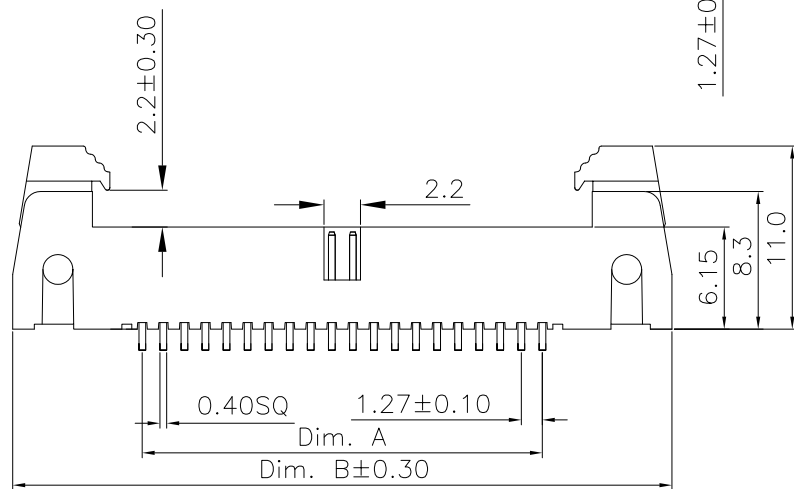
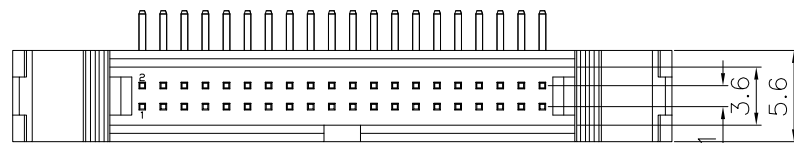

Specifications:

Current rating:1.0A

Voltage rating:50V AC,DC

Contact resistance:20m ohm Max

Insulation resistance:1,000M ohm Min

Withstanding voltage:500V AC/minute

Operating Temperature:-40°C ~ +105°C

Materials:

Insulator:Nylon6T (UL94V-0)

Standard Color:Black

Contact:Brass

Plating:Gold Plated Over Nickel

Circuits	DIM		Circuits	DIM	
	A	B		A	B
10	5.08	20.70	40	24.13	39.75
16	8.89	24.51	44	26.67	42.29
20	11.43	27.05	50	30.48	46.10
26	15.24	30.86	60	36.83	52.45
30	17.78	33.40	68	41.91	57.53
34	20.32	35.94			

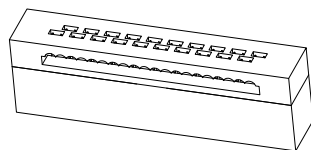
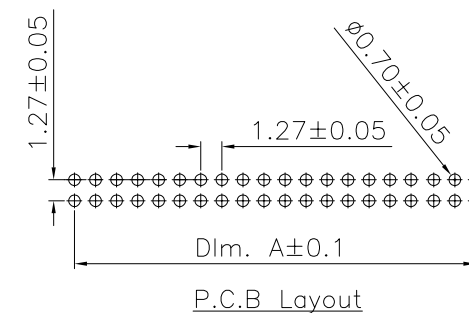
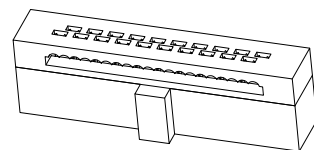
MATING PART
3230-XX-0101-00MATING PART
3230-XX-0102-00

RoHS Compliant

DRAWN:

GENERAL TOLERANCE:

.X=±0.20

.XX=±0.15

CnC Tech

Industrial Cable and Connector Technology

CHECKED:

UNIT: MM

DESCRIPTION:

1.27mm Shrouded Header R/A Type

SIZE

APPROVAL:

SCALE:1:1

PART NO:

3210-XX-002-12-00

A4

PROJECTION:

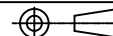

REV

DATE

FILE

BY

05-FEB-2020

A

B

C

D