



Mechanically held lighting contactor, Contactor amp rating 30Amp 0NC _ 6NO poles, 550VAC 50HZ/600VAC 60HZ coil, Non-combination type, Enclosure NEMA type 1, Indoor general purpose use

| | |
|--|---|
| product brand name | Class CLM |
| design of the product | Magnetically latched lighting contactor |
| special product feature | Energy efficient; Quiet operation |
| General technical data | |
| weight [lb] | 20 lb |
| Height x Width x Depth [in] | 16 × 17 × 8 in |
| touch protection against electrical shock | NA for enclosed products |
| installation altitude [ft] at height above sea level maximum | 6560 ft |
| country of origin | USA |
| Contactors | |
| size of contactor | 30 Amp |
| number of NO contacts for main contacts | 6 |
| number of NC contacts for main contacts | 0 |
| operating voltage for main current circuit at AC at 60 Hz maximum | 600 V |
| mechanical service life (operating cycles) of the main contacts typical | 10000000 |
| contact rating of the main contacts of lighting contactor | |
| • at tungsten (1 pole per 1 phase) rated value | 30A @277V 1p 1ph |
| • at tungsten (2 poles per 1 phase) rated value | 30A @480V 2p 1ph |
| • at tungsten (3 poles per 3 phases) rated value | 30A @480V 3p 3ph |
| • at ballast (1 pole per 1 phase) rated value | 30A @347V 1p 1ph |
| • at ballast (2 poles per 1 phase) rated value | 30A @600V 2p 1ph |
| • at ballast (3 poles per 3 phases) rated value | 30A @600V 3p 3ph |
| • at resistive load (1 pole per 1 phase) rated value | 30A @347V 1p 1ph |
| • at resistive load (2 poles per 1 phase) rated value | 30A @600V 2p 1ph |
| • at resistive load (3 poles per 3 phases) rated value | 30A @600V 3p 3ph |
| Auxiliary contact | |
| number of NC contacts for auxiliary contacts | 0 |
| number of NO contacts for auxiliary contacts | 0 |
| number of total auxiliary contacts maximum | 4 |
| contact rating of auxiliary contacts of contactor according to UL | NA |
| Coil | |
| type of voltage of the control supply voltage | AC |
| control supply voltage | |
| • at AC at 50 Hz rated value | 550 V |
| • at AC at 60 Hz rated value | 600 V |
| apparent pick-up power of magnet coil at AC | 820 VA |
| apparent holding power of magnet coil at AC | 80 VA |
| operating range factor control supply voltage rated value of magnet coil | 0.85 ... 1.1 |

| Enclosure | |
|--|------------------------------------|
| degree of protection NEMA rating of the enclosure | NEMA 1 enclosure |
| design of the housing | indoors, usable on a general basis |
| Mounting/wiring | |
| mounting position | Vertical |
| fastening method | Surface mounting and installation |
| type of electrical connection for supply voltage line-side | Screw-type terminals |
| tightening torque [lbf-in] for supply | 18 ... 20 lbf-in |
| type of connectable conductor cross-sections at line-side for AWG cables single or multi-stranded | 2x (14 ... 8 AWG) |
| temperature of the conductor for supply maximum permissible | 75 °C |
| material of the conductor for supply | CU |
| type of electrical connection for load-side outgoing feeder | Screw-type terminals |
| tightening torque [lbf-in] for load-side outgoing feeder | 18 ... 20 lbf-in |
| type of connectable conductor cross-sections for AWG cables for load-side outgoing feeder single or multi-stranded | 2x (14 ... 8 AWG) |
| temperature of the conductor for load-side outgoing feeder maximum permissible | 75 °C |
| material of the conductor for load-side outgoing feeder | CU |
| type of electrical connection of magnet coil | Screw-type terminals |
| tightening torque [lbf-in] at magnet coil | 8 ... 12 lbf-in |
| type of connectable conductor cross-sections of magnet coil for AWG cables single or multi-stranded | 2x (16 ... 12 AWG) |
| temperature of the conductor at magnet coil maximum permissible | 75 °C |
| material of the conductor at magnet coil | CU |
| Short-circuit current rating | |
| design of the fuse link for short-circuit protection of the main circuit required | none |
| design of the short-circuit trip | Thermal magnetic circuit breaker |
| maximum short-circuit current breaking capacity (I _{cu}) | |
| • at 240 V | 5 kA |
| • at 480 V | 5 kA |
| • at 600 V | 5 kA |
| certificate of suitability | NEMA ICS 2; UL 508A |
| Further information | |

Industrial Controls - Product Overview (Catalogs, Brochures,...)

www.usa.siemens.com/iccatalog

Industry Mall (Online ordering system)

<https://mall.industry.siemens.com/mall/en/us/Catalog/product?mlfb=US2:CLM1C06600>

Service&Support (Manuals, Certificates, Characteristics, FAQs,...)

<https://support.industry.siemens.com/cs/US/en/ps/US2:CLM1C06600>

Image database (product images, 2D dimension drawings, 3D models, device circuit diagrams, EPLAN macros, ...)

http://www.automation.siemens.com/bilddb/cax_de.aspx?mlfb=US2:CLM1C06600&lang=en

Certificates/approvals

<https://support.industry.siemens.com/cs/US/en/ps/US2:CLM1C06600/certificate>

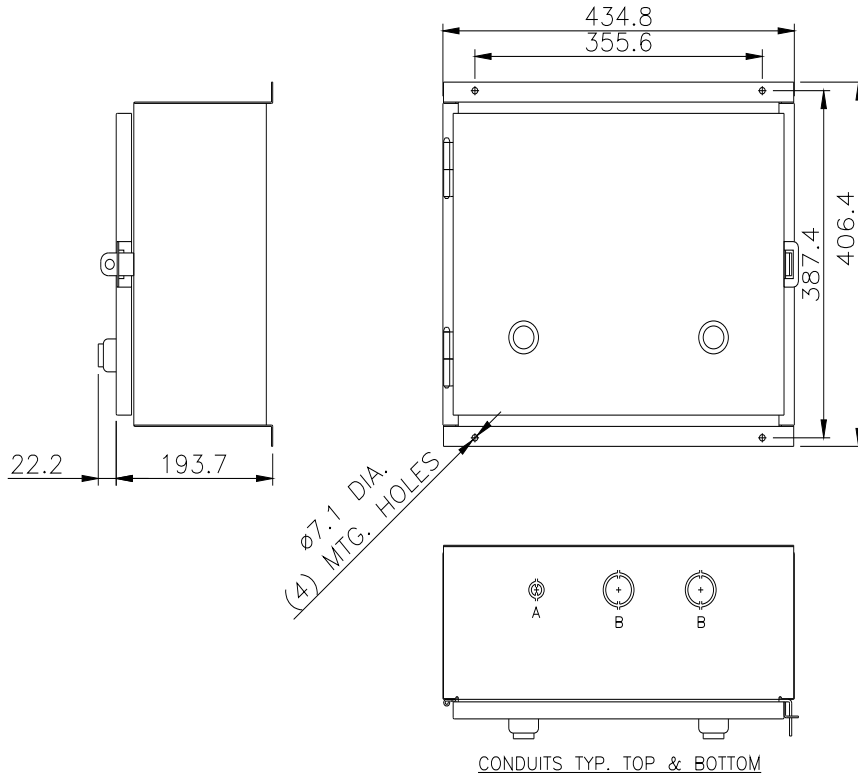

| LETTER | CONDUIT SIZE |
|--------|-----------------------|
| A | ø12.7 & ø19 CONDUIT |
| B | ø31.8 & ø38.1 CONDUIT |

Wiring Diagram Class CLM 30-60 Amp 6 Pole

To Control
Devices

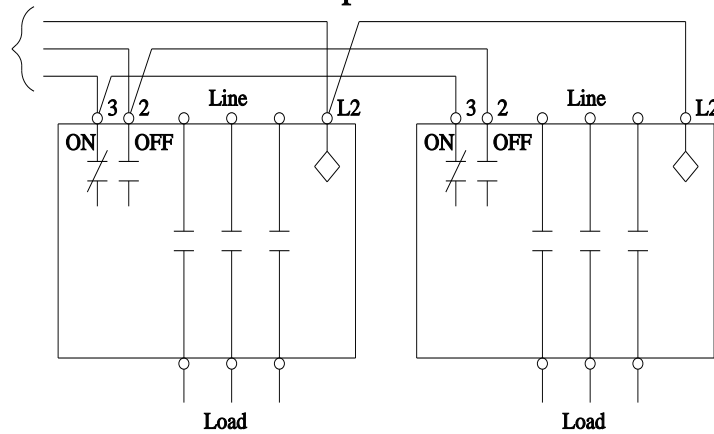

Optional auxiliary contacts are not shown.

E87010-A0410-T009-A1-CLM-2

