

CPDA10C1V5U-HF

RoHS Device
Halogen Free



Features

- IEC 61000-4-2 (ESD) $\pm 16\text{kV}$ (Contact), $\pm 18\text{kV}$ (air).
- Low leakage current.
- Working voltage: 1.5V

Mechanical data

- Case: DFN2510-10 package, molded plastic.
- Terminals: Gold plated, solderable per MIL-STD-750, method 2026.
- Mounting position: Any

Circuit Diagram

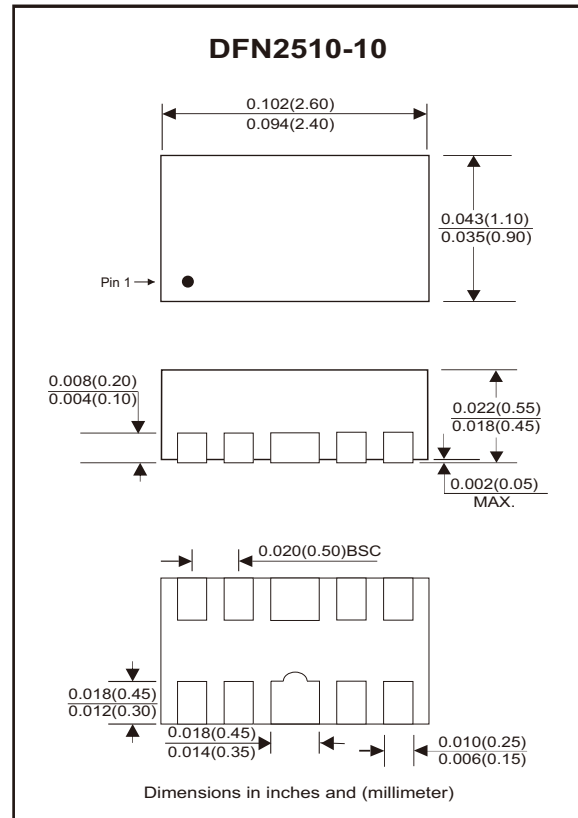
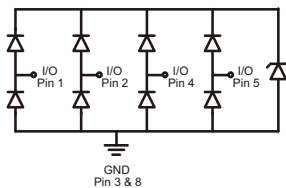

Maximum Rating (at $T_A=25^\circ\text{C}$ unless otherwise noted)

Parameter	Conditions	Symbol	Value	Unit
Peak pulse power	$T_P = 8/20\mu\text{s}$	P_{PP}	45	W
Peak pulse current	$T_P = 8/20\mu\text{s}$	I_{PP}	5	A
ESD capability	IEC 61000-4-2(air) IEC 61000-4-2(contact)	ESD	± 18 ± 16	kV
Operating temperature range		T_j	-55 to +125	$^\circ\text{C}$
Storage temperature range		T_{STG}	-55 to +150	$^\circ\text{C}$

Electrical Characteristics (at $T_A=25^\circ\text{C}$ unless otherwise noted)

Parameter	Conditions	Symbol	Min	Typ	Max	Unit
Working peak reverse voltage		V_{RWM}			1.5	V
Forward voltage	$I_F = 10\text{mA}$, I/O to GND	V_F			1.2	V
Breakdown voltage	$I_T = 1\text{mA}$, I/O to GND	V_{BR}	2.3			V
Reverse leakage current	$V_{RWM} = 1.5\text{V}$, I/O to GND	I_R			0.5	μA
Clamping voltage	$I_{PP} = 5\text{A}$, $T_P = 8/20\mu\text{s}$, I/O to GND	V_C		7.5	9	V
Junction capacitance	$V_R = 0\text{V}$, $f = 1\text{MHz}$, I/O to GND	C_J		0.6	0.8	pF
	$V_R = 0\text{V}$, $f = 1\text{MHz}$, I/O to I/O	C_J		0.25		pF

Rating and Characteristic Curves (CPDA10C1V5U-HF)

Fig.1 - 8/20 μ s Peak Pulse Current Waveform Acc. IEC 61000-4-5

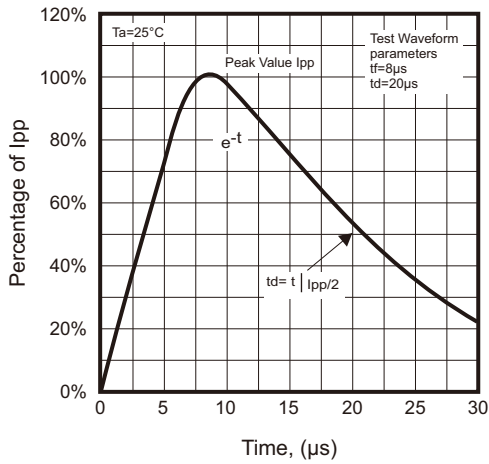

Fig.2 - Power Rating Derating Curve

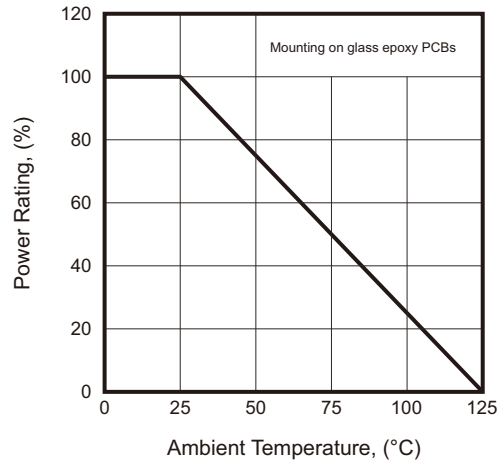

Fig.3 - Typical Clamping Voltage vs. Peak Pulse Current

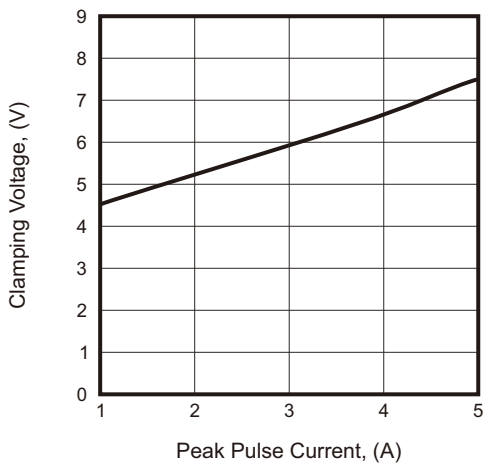
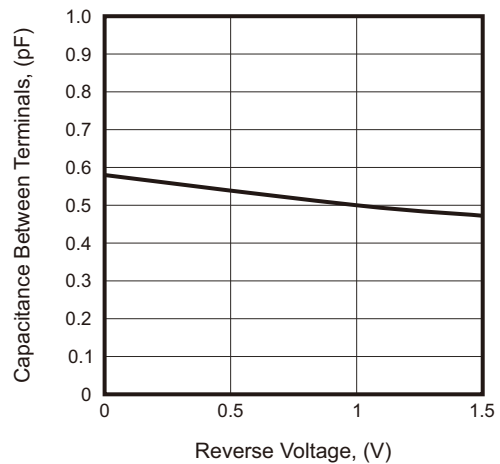
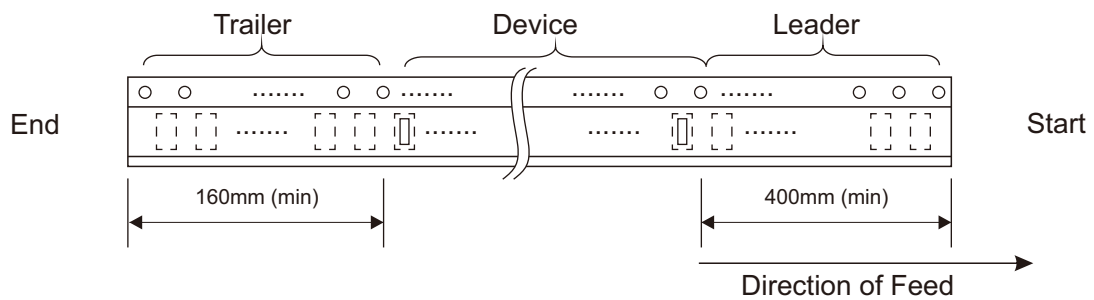
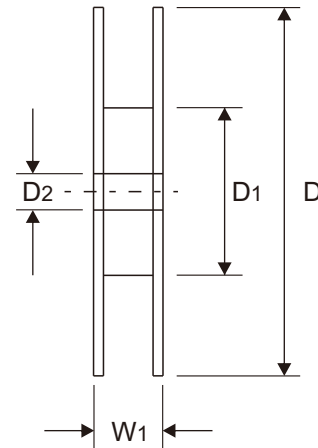
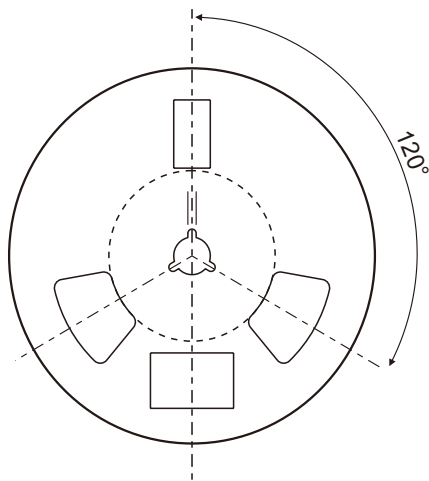
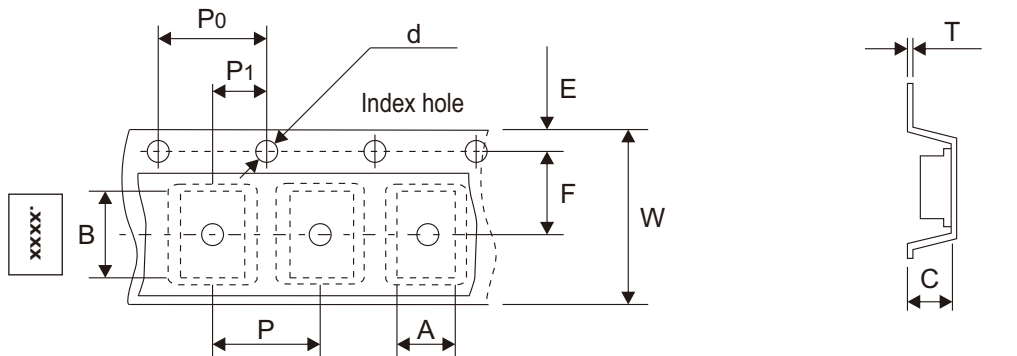

Fig.4 - Typical Capacitance Between Terminals Characteristics



Reel Taping Specification



DFN2510-10	SYMBOL	A	B	C	d	D	D1	D2
	(mm)	1.14 ± 0.05	2.64 ± 0.05	0.64 ± 0.05	1.50 + 0.10 - 0.00	178.00 ± 1.00	60.00 ± 0.50	13.50 ± 0.20
	(inch)	0.045 ± 0.002	0.104 ± 0.002	0.025 ± 0.002	0.059 + 0.004 - 0.000	7.008 ± 0.039	2.362 ± 0.020	0.531 ± 0.008

DFN2510-10	SYMBOL	E	F	P	P0	P1	T	W	W1
	(mm)	1.75 ± 0.10	3.50 ± 0.05	4.00 ± 0.10	4.00 ± 0.10	2.00 ± 0.05	0.20 ± 0.05	8.00 ± 0.30	12.00 + 0.50 - 0.00
	(inch)	0.069 ± 0.004	0.138 ± 0.002	0.157 ± 0.004	0.157 ± 0.004	0.079 ± 0.002	0.008 ± 0.002	0.315 ± 0.012	0.472 + 0.020 - 0.000

Company reserves the right to improve product design, functions and reliability without notice.

REV:A

Marking Code

Part Number	Marking Code
CPDA10C1V5U-HF	.E1V5



Suggested P.C.B. PAD Layout

SIZE	DFN2510-10	
	(mm)	(inch)
A	2.25	0.089
B	1.40	0.055
C	0.615	0.024
D	0.25	0.010
E	0.40	0.016
F	0.50	0.020
G	0.17	0.007

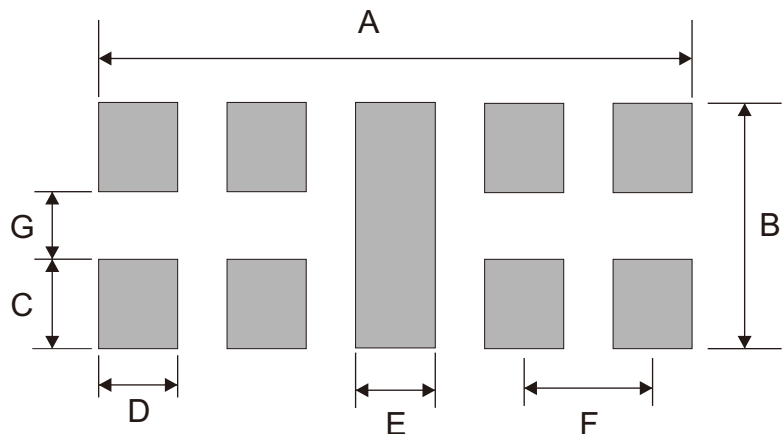

Note: 1.The pad layout is for reference purposes only.

Standard Packaging

Case Type	REEL PACK	
	REEL (pcs)	Reel Size (inch)
DFN2510-10	3,000	7