

Click [here](#) to ask an associate for production status of specific part numbers.

Dual, SiGe, High-Linearity, 1700MHz to 2700MHz Downconversion Mixer with LO Buffer/Switch

MAX9995

General Description

The MAX9995 dual, high-linearity, downconversion mixer provides 6.1dB gain, +25.6dBm IIP3, and 9.8dB NF for WCDMA, TD-SCDMA, LTE, TD-LTE, and GSM/EDGE base-station applications.

This device integrates baluns in the RF and LO ports, a dual-input LO selectable switch, an LO buffer, two double-balanced mixers, and a pair of differential IF output amplifiers. The MAX9995 requires a typical LO drive of 0dBm and supply current is guaranteed to be below 380mA.

These devices are available in a compact 36-pin TQFN package (6mm x 6mm) with an exposed pad. Electrical performance is guaranteed over the extended temperature range, from $T_C = -40^\circ\text{C}$ to $+100^\circ\text{C}$.

Applications

- WCDMA, TD-SCDMA, and cdma2000® 3G Base Stations
- LTE and TD-LTE Base Stations
- GSM/EDGE Base Stations
- PHS/PAS Base Stations
- Fixed Broadband Wireless Access
- Wireless Local Loop
- Private Mobile Radio
- Military Systems

Pin Configuration/ Functional Diagram

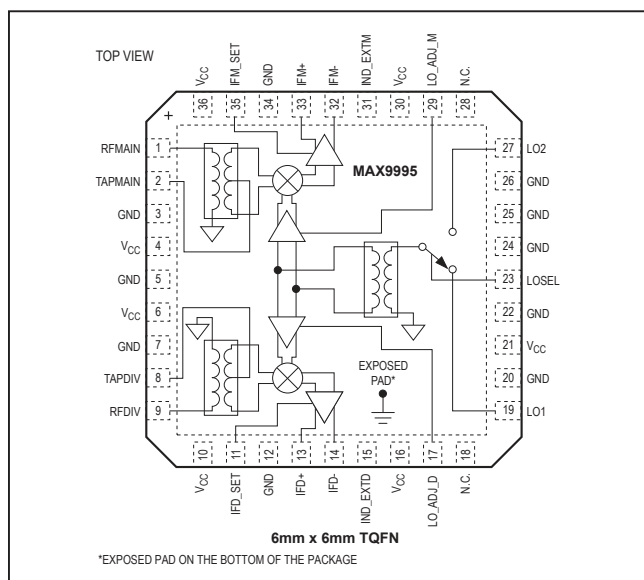

Features

- 1700MHz to 2700MHz RF Frequency Range
- 1400MHz to 2600MHz LO Frequency Range
- 40MHz to 350MHz IF Frequency Range
- 6.1dB Conversion Gain
- +25.6dBm Input IP3
- 9.8dB Noise Figure
- 66dBc 2RF - 2LO Spurious Rejection at $P_{RF} = -10\text{dBm}$
- Dual Channels Ideal for Diversity Receiver Applications
- Integrated LO Buffer
- Integrated RF and LO Baluns for Single-Ended Inputs
- Low -3dBm to +3dBm LO Drive
- Built-In SPDT LO Switch with 50dB LO1 - LO2 Isolation and 50ns Switching Time
- 44dB Channel-to-Channel Isolation

Ordering Information

PART	TEMP RANGE	PIN-PACKAGE
MAX9995ETX+	$T_C^* = -40^\circ\text{C}$ to $+100^\circ\text{C}$	36 TQFN-EP**
MAX9995ETX+T	$T_C^* = -40^\circ\text{C}$ to $+100^\circ\text{C}$	36 TQFN-EP**

+Denotes a lead(PB)-free and RoHS-compliant package.

* T_C = Case temperature.

**EP = Exposed pad.

T = Tape and reel.

cdma2000 is a registered trademark of Telecommunications Industry Association.

19-3383; Rev 3; 1/21

Absolute Maximum Ratings

V _{CC}	-0.3V to +5.5V	Continuous Power Dissipation (Note 1).....	6.75W
LO1, LO2 to GND.....	±0.3V	Operating Temperature Range (Note 2).....	T _C = -40°C to +100°C
IFM_, IFD_, IFM_SET, IFD_SET, LOSEL, LO_ADJ_M, LO_ADJ_D to GND.....	-0.3V to (V _{CC} + 0.3V)	Maximum Junction Temperature	+150°C
RFMAIN, RFDIV, and LO_ Input Power.....	+20dBm	Storage Temperature Range	-65°C to +150°C
RFMAIN, RFDIV Current (RF is DC shorted to GND through balun).....	50mA	Lead Temperature (soldering, 10s)	+300°C
		Soldering Temperature (reflow).....	+260°C

Note 1: Based on junction temperature $T_J = T_C + (\theta_{JC} \times V_{CC} \times I_{CC})$. This formula can be used when the temperature of the exposed pad is known while the device is soldered down to a PCB. See the Applications Information section for details. The junction temperature must not exceed +150°C.

Note 2: T_C is the temperature on the exposed pad of the package. T_A is the ambient temperature of the device and PCB.

Stresses beyond those listed under "Absolute Maximum Ratings" may cause permanent damage to the device. These are stress ratings only, and functional operation of the device at these or any other conditions beyond those indicated in the operational sections of the specifications is not implied. Exposure to absolute maximum rating conditions for extended periods may affect device reliability.

Package Thermal Characteristics

TQFN		Junction-to-Case Thermal Resistance (θ _{JC}) (Note 1, 4).....	7.4°C/W
Junction-to-Ambient Thermal Resistance (θ _{JA}) (Note 3, 4).....	38°C/W		
Junction-to-Board Thermal Resistance (θ _{JB}).....	12.2°C/W		

Note 3: Junction temperature $T_J = T_A + (\theta_{JA} \times V_{CC} \times I_{CC})$. This formula can be used when the ambient temperature of the PCB is known. The junction temperature must not exceed +150°C.

Note 4: Package thermal resistances were obtained using the method described in JEDEC specification JESD51-7, using a four-layer board. For detailed information on package thermal considerations, refer to www.maximintegrated.com/thermal-tutorial.

DC Electrical Characteristics

(Typical Application Circuit, no input RF or LO signals applied, V_{CC} = 4.75V to 5.25V, T_C = -40°C to +85°C. Typical values are at V_{CC} = 5.0V, T_C = +25°C, unless otherwise noted.)

PARAMETER	SYMBOL	CONDITIONS	MIN	TYP	MAX	UNITS
Supply Voltage	V _{CC}		4.75	5	5.25	V
Supply Current	I _{CC}	Total supply current		332	380	mA
		V _{CC} (pin 16)		82	90	
		V _{CC} (pin 30)		97	110	
		IFM+/IFM- (total of both)		70	90	
		IFD+/IFD- (total of both)		70	90	
LOSEL Input High Voltage	V _{IH}		2			V
LOSEL Input Low Voltage	V _{IL}				0.8	V
LOSEL Input Current	I _{IL} and I _{IH}		-10		+10	µA

Recommended AC Operating Conditions

PARAMETER	SYMBOL	CONDITIONS	MIN	TYP	MAX	UNITS
RF Frequency Range	f _{RF}	(Note 5)	1700		2700	MHz
LO Frequency Range	f _{LO}	(Note 5)	1400		2600	MHz
IF Frequency Range	f _{IF}	(Note 5)	40		350	MHz
LO Drive Level	P _{LO}	(Note 5)	-3		+3	dBm

AC Electrical Characteristics— $f_{RF} = 1700\text{MHz TO } 2200\text{MHz}$

(Typical Application Circuit, $V_{CC} = 4.75\text{V to } 5.25\text{V}$, RF and LO ports are driven from 50Ω sources, $P_{LO} = -3\text{dBm to } +3\text{dBm}$, $f_{RF} = 1700\text{MHz to } 2200\text{MHz}$, $f_{LO} = 1400\text{MHz to } 2000\text{MHz}$, $f_{IF} = 200\text{MHz}$, with $f_{RF} > f_{LO}$, $T_C = -40^\circ\text{C to } +85^\circ\text{C}$. Typical values are at $V_{CC} = 5.0\text{V}$, $P_{LO} = 0\text{dBm}$, $f_{RF} = 1900\text{MHz}$, $f_{LO} = 1700\text{MHz}$, $f_{IF} = 200\text{MHz}$, and $T_C = +25^\circ\text{C}$, unless otherwise noted.) (Notes 6, 7)

PARAMETER	SYMBOL	CONDITIONS		MIN	TYP	MAX	UNITS
Conversion Gain	G_C		$f_{RF} = 1710\text{MHz to } 1875\text{MHz}$		6		dB
			$f_{RF} = 1850\text{MHz to } 1910\text{MHz}$		6.2		
			$T_C = +100^\circ\text{C}$		4.6		
			$f_{RF} = 2110\text{MHz to } 2170\text{MHz}$		6.1		
Gain Variation from Nominal		$V_{CC} = 5.0\text{V}$, $T_C = +25^\circ\text{C}$, $P_{LO} = 0\text{dBm}$, $P_{RF} = -10\text{dBm}$	$f_{RF} = 1710\text{MHz to } 1875\text{MHz}$		± 0.5	± 1	dB
			$f_{RF} = 1850\text{MHz to } 1910\text{MHz}$		± 0.5	± 1	
			$f_{RF} = 2110\text{MHz to } 2170\text{MHz}$		± 0.5	± 1	
Gain Variation with Temperature					± 0.75		dB
Noise Figure	NF	No blockers present	$f_{RF} = 1710\text{MHz to } 1875\text{MHz}$		9.7		dB
			$f_{RF} = 1850\text{MHz to } 1910\text{MHz}$		9.8		
			$f_{RF} = 2110\text{MHz to } 2170\text{MHz}$		9.9		
Noise Figure (with Blocker)		8dBm blocker tone applied to RF port at 2000MHz, $f_{RF} = 1900\text{MHz}$, $f_{LO} = 1710\text{MHz}$, $P_{LO} = -3\text{dBm}$			22		dB
Input 1dB Compression Point	$P_{1\text{dB}}$	(Note 8)		9.5	12.6		dBm
Input Third-Order Intercept Point	IIP3	(Notes 8, 9)		23	25.6		dBm
		$T_C = +100^\circ\text{C}$, Note 9				26.1	
2RF - 2LO Spur Rejection	2×2	$f_{RF} = 1900\text{MHz}$, $f_{LO} = 1700\text{MHz}$, $f_{\text{SPUR}} = 1800\text{MHz}$	$P_{RF} = -10\text{dBm}$		66		dBc
			$P_{RF} = -10\text{dBm}$, $T_C = +100^\circ\text{C}$		73.3		
			$P_{RF} = -5\text{dBm}$		61		
			$P_{RF} = -5\text{dBm}$, $T_C = +100^\circ\text{C}$		68.3		
3RF - 3LO Spur Rejection	3×3	$f_{RF} = 1900\text{MHz}$, $f_{LO} = 1700\text{MHz}$, $f_{\text{SPUR}} = 1766.7\text{MHz}$	$P_{RF} = -10\text{dBm}$	70	88		dBc
			$P_{RF} = -10\text{dBm}$, $T_C = +100^\circ\text{C}$		84.5		
			$P_{RF} = -5\text{dBm}$	60	78		
			$P_{RF} = -5\text{dBm}$, $T_C = +100^\circ\text{C}$		74.5		
Maximum LO Leakage at RF Port		$f_{LO} = 1400\text{MHz to } 2000\text{MHz}$		-29			dBm
Maximum 2LO Leakage at RF Port		$f_{LO} = 1400\text{MHz to } 2000\text{MHz}$		-17			dBm
Maximum LO Leakage at IF Port		$f_{LO} = 1400\text{MHz to } 2000\text{MHz}$		-25			dBm
				$T_C = +100^\circ\text{C}$		-50.4	
Minimum RF-to-IF Isolation		$f_{RF} = 1700\text{MHz to } 2200\text{MHz}$, $f_{IF} = 200\text{MHz}$		37			dB
				$T_C = +100^\circ\text{C}$		44	
LO1 - LO2 Isolation		$P_{LO1} = 0\text{dBm}$, $P_{LO2} = 0\text{dBm}$ (Note 10)		40	50.5		dB
Minimum Channel-to-Channel Isolation		$P_{RF} = -10\text{dBm}$, RFMAIN (RFDIV) power measured at IFDIV (IFMAIN), relative to IFMAIN (IFDIV), all unused ports terminated at 50Ω		40	44		dB
				$T_C = +100^\circ\text{C}$		54.7	
LO Switching Time		50% of LOSEL to IF settled to within 2°		50			ns

AC Electrical Characteristics— $f_{RF} = 2540\text{MHz}$

(Typical Application Circuit, RF and LO ports are driven from 50Ω sources, $f_{RF} > f_{LO}$, $V_{CC} = 5.0\text{V}$, $P_{RF} = -5\text{dBm}$, $P_{LO} = 0\text{dBm}$, $f_{RF} = 2540\text{MHz}$, $f_{LO} = 2400\text{MHz}$, $f_{IF} = 140\text{MHz}$, $T_C = +25^\circ\text{C}$, unless otherwise noted.) (Note 7)

PARAMETER	SYMBOL	CONDITIONS	MIN	TYP	MAX	UNITS
RF Return Loss				14		dB
LO Return Loss		LO port selected		18		dB
		LO port unselected		21		
IF Return Loss		LO driven at 0dBm, RF terminated into 50Ω (Note 11)		21		dB
Conversion Gain	G_C			5.2		dB
Input Third-Order Intercept Point	IIP3	Two tones: $f_{RF1} = 2540\text{MHz}$, $f_{RF2} = 2541\text{MHz}$, $P_{RF} = -5\text{dBm/ tone}$		24.6		dBm
2RF - 2LO Spurious Response	2 x 2	$P_{RF} = -10\text{dBm}$		58		dBc
		$P_{RF} = -5\text{dBm}$		63		
3RF - 3LO Spurious Response	3 x 3	$P_{RF} = -10\text{dBm}$		72		dBc
		$P_{RF} = -5\text{dBm}$		82		
LO Leakage at IF Port				-45		dBm
RF-to-IF Isolation				49		dB
Channel-to-Channel Isolation		$P_{RF} = -10\text{dBm}$, RFMAIN (RFDIV) power measured at IFDIV (IFMAIN), relative to IFMAIN (IFDIV), all unused ports terminated at 50Ω		48		dB

Note 5: Operation outside this frequency band is possible but has not been characterized. See the Typical Operating Characteristics.

Note 6: Guaranteed by design and characterization.

Note 7: All limits reflect losses of external components. Output measurements taken at IF outputs of Typical Application Circuit.

Note 8: Production tested.

Note 9: Two tones 3MHz spacing, -5dBm per tone at RF port.

Note 10: Measured at IF port at IF frequency. f_{LO1} and f_{LO2} are offset by 1MHz.

Note 11: IF return loss can be optimized by external matching components.

Typical Operating Characteristics

(Typical Application Circuit, $V_{CC} = 5.0\text{V}$, $P_{RF} = -5\text{dBm}$, $P_{LO} = 0\text{dBm}$, LO is low-side injected for a 200MHz IF, $T_C = +25^\circ\text{C}$.)

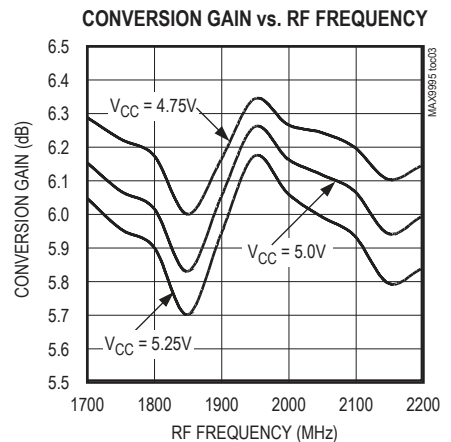
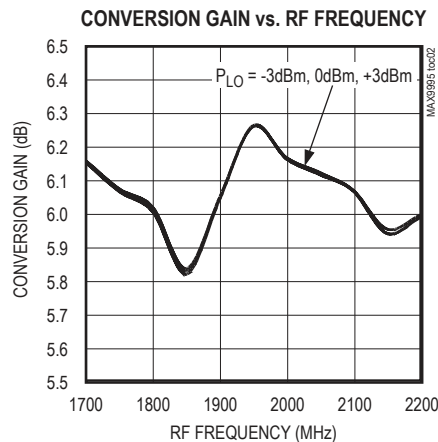
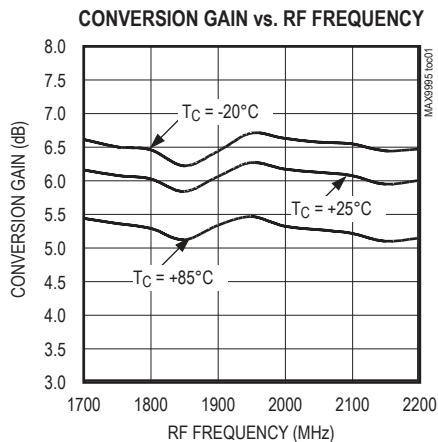

Typical Operating Characteristics (continued)

(Typical Application Circuit, $V_{CC} = 5.0V$, $P_{RF} = -5dBm$, $P_{LO} = 0dBm$, LO is low-side injected for a 200MHz IF, $T_C = +25^{\circ}C$.)

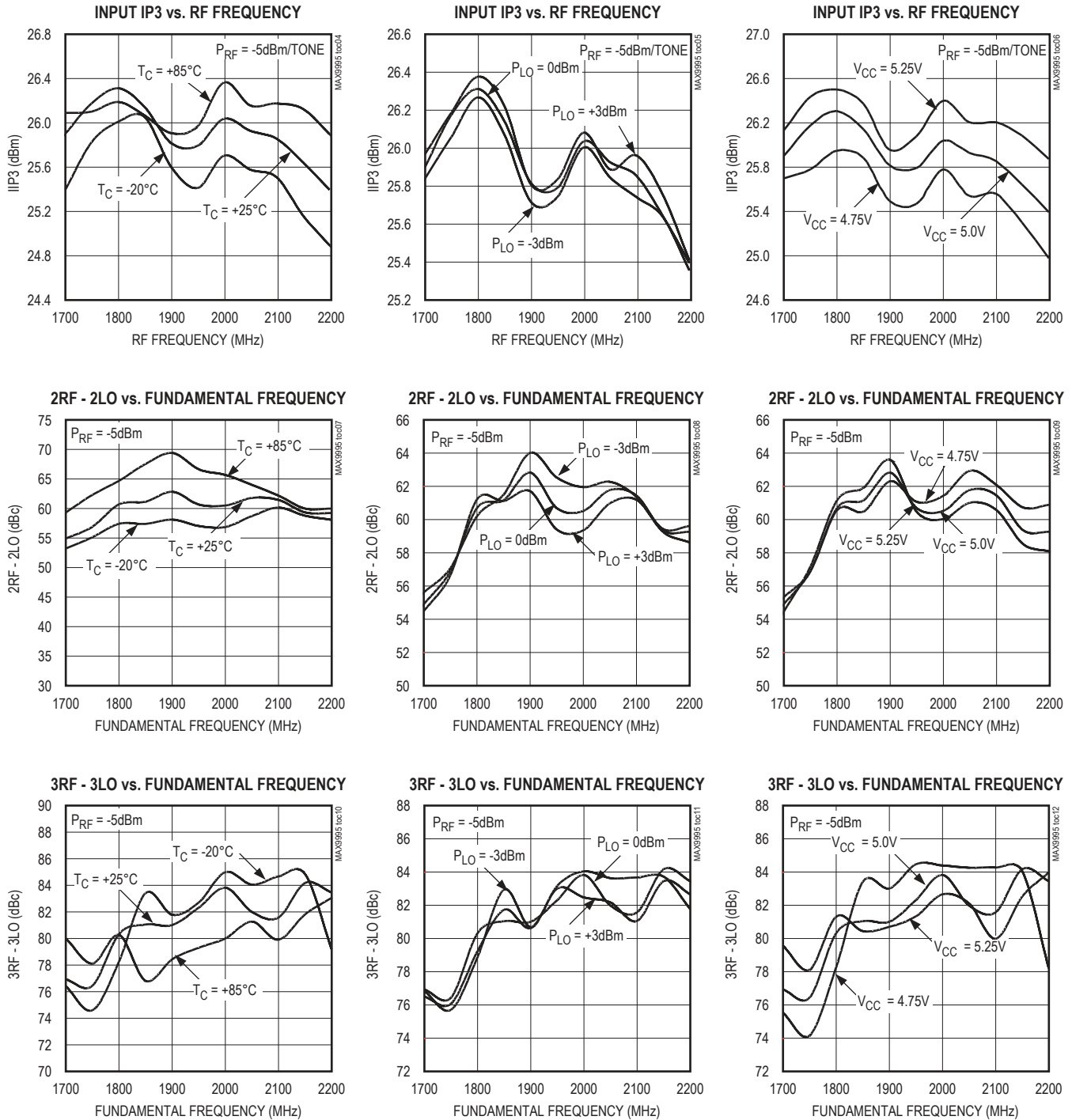

Typical Operating Characteristics (continued)

(Typical Application Circuit, $V_{CC} = 5.0V$, $P_{RF} = -5dBm$, $P_{LO} = 0dBm$, LO is low-side injected for a 200MHz IF, $T_C = +25^\circ C$.)

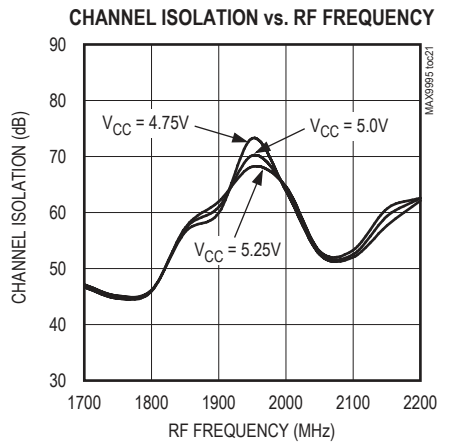
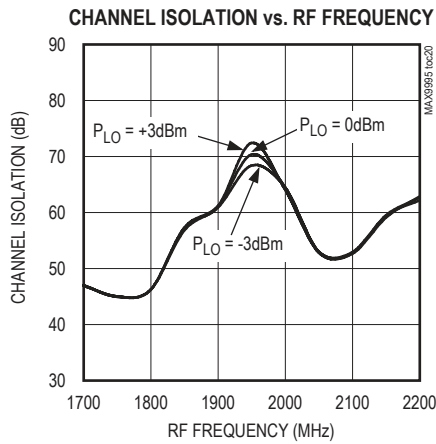
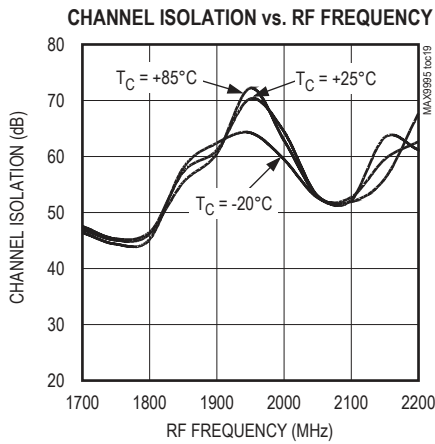
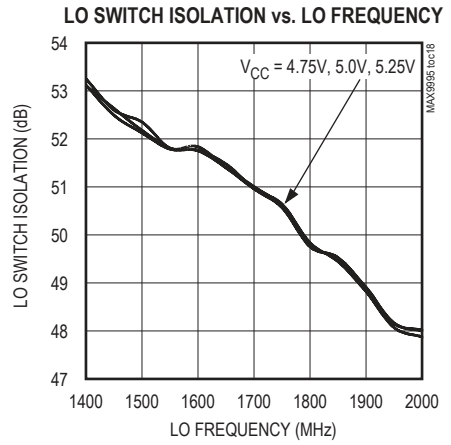
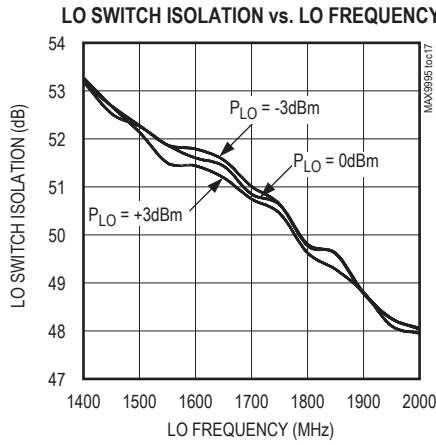
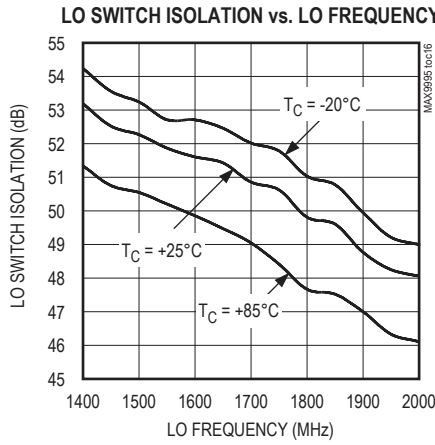
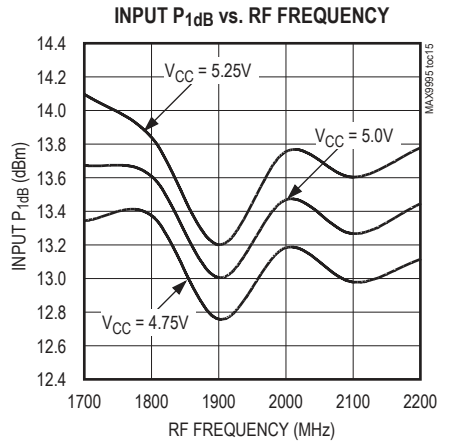
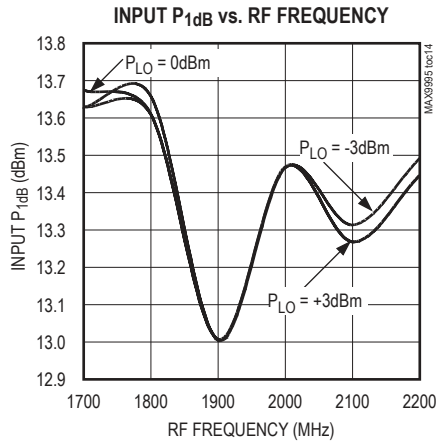
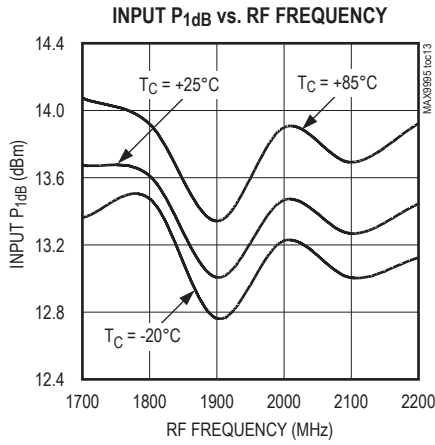

Typical Operating Characteristics (continued)

(Typical Application Circuit, $V_{CC} = 5.0V$, $P_{RF} = -5dBm$, $P_{LO} = 0dBm$, LO is low-side injected for a 200MHz IF, $T_C = +25^\circ C$.)

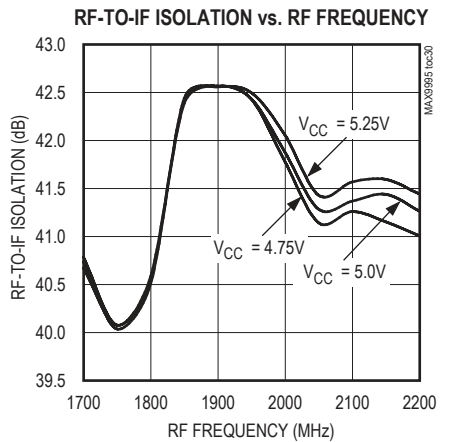
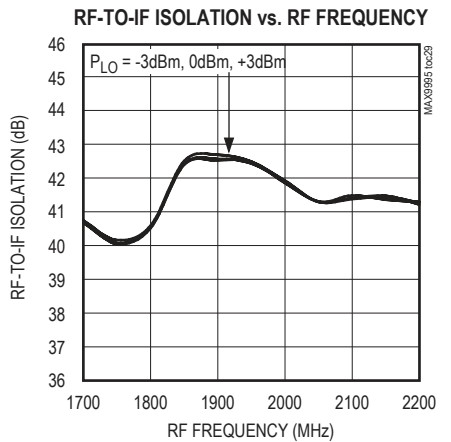
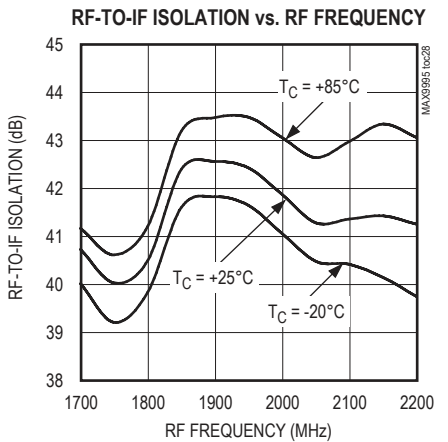
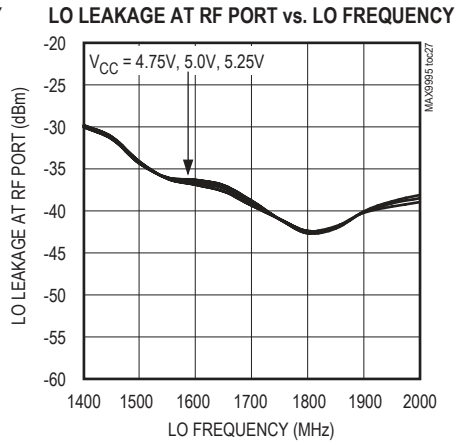
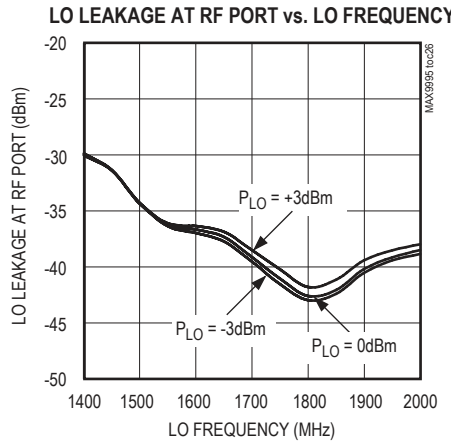
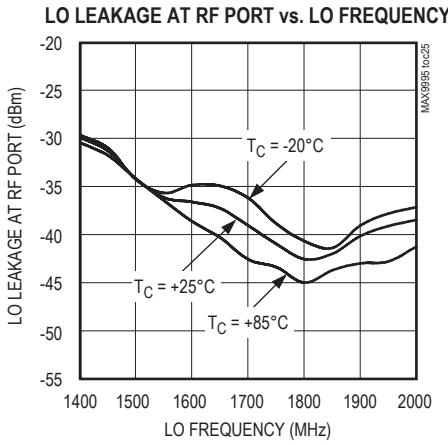
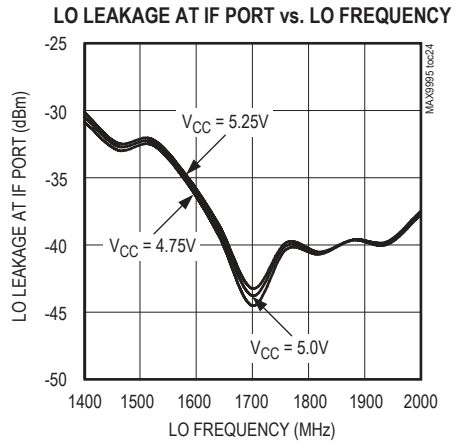
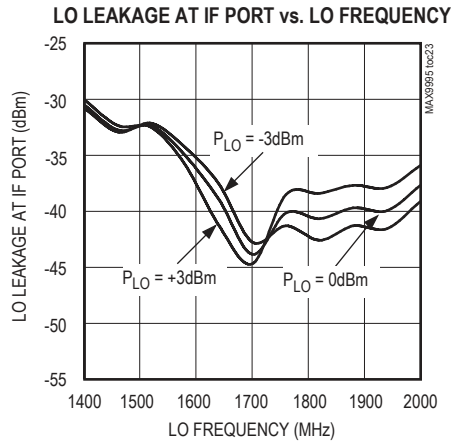
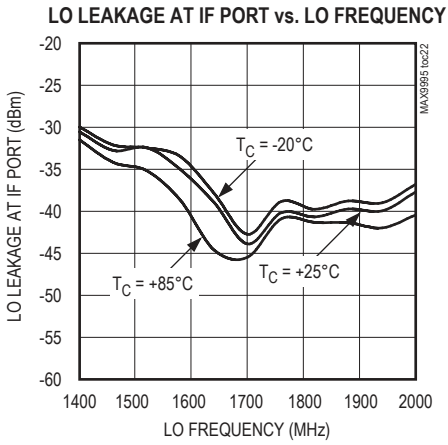

Typical Operating Characteristics (continued)

(Typical Application Circuit, $V_{CC} = 5.0V$, $P_{RF} = -5dBm$, $P_{LO} = 0dBm$, LO is low-side injected for a 200MHz IF, $T_C = +25^\circ C$.)

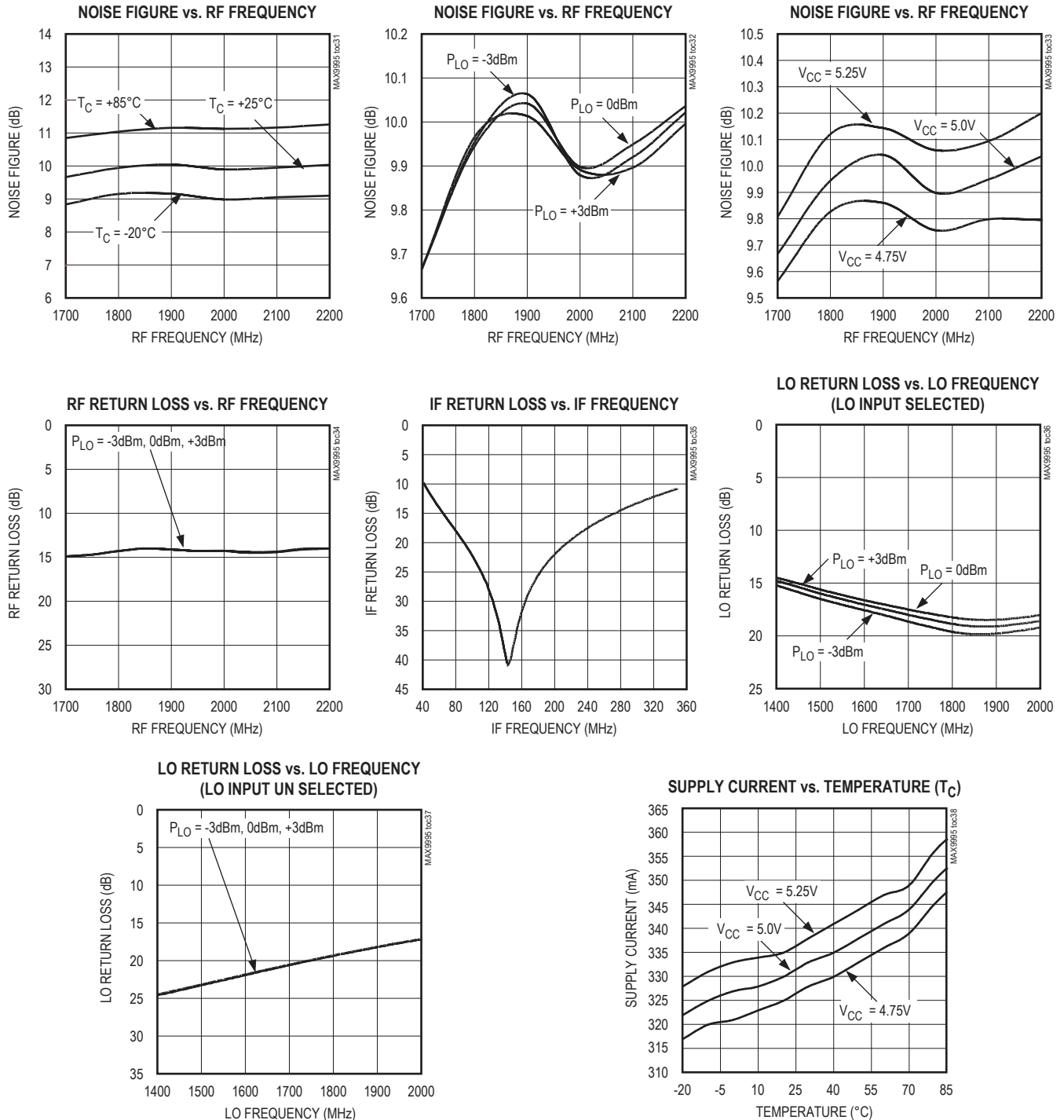

Pin Description

PIN	NAME	FUNCTION
1	RFMAIN	Main Channel RF Input. Internally matched to 50Ω. Requires an input DC-blocking capacitor.
2	TAPMAIN	Main Channel Balun Center Tap. Connect a 0.033μF capacitor from this pin to the board ground.
3, 5, 7, 12, 20, 22, 24, 25, 26, 34	GND	Ground
4, 6, 10, 16, 21, 30, 36	V _{CC}	Power Supply. Connect bypass capacitors as close as possible to the pin (see the <i>Typical Application Circuit</i>).
8	TAPDIV	Diversity Channel Balun Center Tap. Connect a 0.033μF capacitor from this pin to the ground.
9	RFDIV	Diversity Channel RF Input. Internally matched to 50Ω. Requires an input DC-blocking capacitor.
11	IFD_SET	IF Diversity Amplifier Bias Control. Connect a 1.2kΩ resistor from this pin to ground to set the bias current for the diversity IF amplifier.
13, 14	IFD+, IFD-	Diversity Mixer Differential IF Output. Connect pullup inductors from each of these pins to V _{CC} (see the <i>Typical Application Circuit</i>).
15	IND_EXTD	Connect a 10nH inductor from this pin to ground to increase the RF-IF and LO-IF isolation.
17	LO_ADJ_D	LO Diversity Amplifier Bias Control. Connect a 392Ω resistor from this pin to ground to set the bias current for the diversity LO amplifier.
18, 28	N.C.	No Connection. Not internally connected.
19	LO1	Local Oscillator 1 Input. This input is internally matched to 50Ω. Requires an input DC-blocking capacitor.
23	LOSEL	Local Oscillator Select. Set this pin to high to select LO1. Set to low to select LO2.
27	LO2	Local Oscillator 2 Input. This input is internally matched to 50Ω. Requires an input DC-blocking capacitor.
29	LO_ADJ_M	LO Main Amplifier Bias Control. Connect a 392Ω resistor from this pin to ground to set the bias current for the main LO amplifier.
31	IND_EXTM	Connect a 10nH inductor from this pin to ground to increase the RF-IF and LO-IF isolation.
32, 33	IFM-, IFM+	Main Mixer Differential IF Output. Connect pullup inductors from each of these pins to V _{CC} (see the <i>Typical Application Circuit</i>).
35	IFM_SET	IF Main Amplifier Bias Control. Connect a 1.2kΩ resistor from this pin to ground to set the bias current for the main IF amplifier.
—	EP	Exposed Pad. Internally connected to GND. Solder this exposed pad to a PCB pad that uses multiple ground vias to provide heat transfer out of the device into the PCB ground planes. These multiple via grounds are also required to achieve the noted RF performance.

Detailed Description

The MAX9995 dual, high-linearity, downconversion mixer provides 6.1dB gain and +25.6dBm IIP3, with a 9.8dB noise figure. Integrated baluns and matching circuitry allow 50Ω single-ended interfaces to the RF and LO ports. A single-pole, double-throw (SPDT) LO switch provides 50ns switching time between LO inputs, with 50dB LO-to-LO isolation. Furthermore, the integrated LO buffer provides a high drive level to the mixer core, reducing the LO drive required at the MAX9995's inputs to -3dBm. The IF port incorporates a differential output, which is ideal for providing enhanced 2RF - 2LO performance.

Specifications are guaranteed over broad frequency ranges to allow for use in WCDMA, TD-SCDMA, LTE, TD-LTE, and GSM/EDGE base stations. The MAX9995 is specified to operate over an RF input range of 1700MHz to 2700MHz, an LO range of 1400MHz to 2600MHz, and an IF range of 40MHz to 350MHz. Operation beyond this is possible; however, performance is not characterized. This device is available in a compact 6mm x 6mm, 36-pin TQFN package with an exposed pad.

RF Input and Balun

The MAX9995's two RF inputs (RFMAIN and RFDIV) are internally matched to 50Ω, requiring no external matching components. DC-blocking capacitors are required as the inputs are internally DC shorted to ground through the on-chip baluns. Input return loss is typically 14dB over the entire RF frequency range of 1700MHz to 2700MHz.

LO Input, Switch, Buffer, and Balun

The mixers can be used for either high-side or low-side injection applications with an LO frequency range of 1400MHz to 2600MHz. As an added feature, the MAX9995 includes an internal LO SPDT switch that can be used for frequency-hopping applications. The switch selects one of the two single-ended LO ports, allowing the external oscillator to settle on a particular frequency before it is switched in. LO switching time is typically less than 50ns, which is more than adequate for virtually all GSM applications. If frequency hopping is not employed, set the switch to either of the LO inputs. The switch is controlled by a digital input (LOSEL): logic-high selects LO1, and logic-low selects LO2. LO1 and LO2 inputs are internally matched to 50Ω, requiring only a 22pF DC-blocking capacitor.

A two-stage internal LO buffer allows a wide input power range for the LO drive. All guaranteed specifications are for an LO signal power from -3dBm to +3dBm.

The on-chip low-loss balun, along with an LO buffer, drives the double-balanced mixer. All interfacing and matching components from the LO inputs to the IF outputs are integrated on-chip.

High-Linearity Mixers

The core of the MAX9995 is a pair of double-balanced, high-performance passive mixers. Exceptional linearity is provided by the large LO swing from the on-chip LO buffer. When combined with the integrated IF amplifiers, the cascaded IIP3, 2RF - 2LO rejection, and NF performance is typically +25.6dBm, 66dBc, and 9.8dB, respectively.

Differential IF Output Amplifiers

The MAX9995 mixers have an IF frequency range of 40MHz to 350MHz. The differential, open-collector IF output ports require external pullup inductors to V_{CC} . Note that these differential outputs are ideal for providing enhanced 2RF - 2LO rejection performance. Single-ended IF applications require a 4:1 balun to transform the 200Ω differential output impedance to a 50Ω single-ended output. After the balun, VSWR is typically 1.5:1.

Applications Information

Input and Output Matching

The RF and LO inputs are internally matched to 50Ω. No matching components are required. Return loss at each RF port is typically 14dB over the entire input range (1700MHz to 2700MHz), and return loss at the LO ports is typically 18dB (1400MHz to 2000MHz). RF and LO inputs require only DC-blocking capacitors for interfacing. The IF output impedance is 200Ω (differential). For evaluation, an external low-loss 4:1 (impedance ratio) balun transforms this impedance down to a 50Ω single-ended output (see the Typical Application Circuit).

Bias Resistors

Bias currents for the LO buffer and the IF amplifier are optimized by fine tuning the resistors (R1, R2, R4, and R5). If reduced current is required at the expense of performance, contact the factory. If the ±1% bias resistor values are not readily available, substitute standard ±5% values.

INDEXTM and INDEXTD Inductors

Short INDEXTM and INDEXTD to ground using 0Ω resistors. For applications requiring improved RF-to-IF and LO-to-IF isolation, use 10nH inductors (L3 and L6) in place of the 0Ω resistors. However, to ensure stable operation, the mixer IF ports must be presented with low common-mode load impedance. Contact the factory for details. Since approximately 100mA flows through INDEXTM and INDEXTD, it is important to use low-DCR wire-wound inductors.

Layout Considerations

A properly designed PCB is an essential part of any RF/microwave circuit. Keep RF signal lines as short as possible to reduce losses, radiation, and inductance. For the best performance, route the ground pin traces directly to the exposed pad under the package. The PCB exposed pad **MUST** be connected to the ground plane of the PCB. It is suggested that multiple vias be used to connect this pad to the lower-level ground planes. This method provides a good RF/thermal-conduction path for the device. Solder the exposed pad on the bottom of the device package to the PCB. The MAX9995 evaluation kit can be used as a reference for board layout. Gerber files are available upon request at www.maximintegrated.com.

Power-Supply Bypassing

Proper voltage-supply bypassing is essential for high-frequency circuit stability. Bypass each V_{CC} pin with a capacitor as close as possible to the pin (*Typical Application Circuit*).

Exposed Pad RF/Thermal Considerations

The exposed pad (EP) of the MAX9995's 36-pin TQFN-EP package provides a low thermal-resistance path to the die. It is important that the PCB on which the MAX9995 is mounted be designed to conduct heat from the EP. In addition, provide the EP with a low-inductance path to electrical ground. The EP **MUST** be soldered to a ground plane on the PCB, either directly or through an array of plated via holes.

Table 1. Component Values

COMPONENT	VALUE	DESCRIPTION
C1, C8	4pF	Microwave capacitors (0402)
C2, C7	10pF	Microwave capacitors (0402)
C3, C6	0.033μF	Microwave capacitors (0603)
C4, C5, C14, C16	22pF	Microwave capacitors (0402)
C9, C13, C15, C17, C18	0.01μF	Microwave capacitors (0402)
C10, C11, C12, C19, C20, C21	150pF	Microwave capacitors (0603)
L1, L2, L4, L5	330nH	Wire-wound high-Q inductors (0805)
L3, L6	10nH	Wire-wound high-Q inductors (0603)
R1, R4	1.21kΩ	±1% resistors (0402)
R2, R5	392Ω	±1% resistors (0402)
R3, R6	10Ω	±1% resistors (1206)
T1, T2	4:1 (200:50)	IF baluns

Chip Information

PROCESS: BiCMOS

Lead-Free/RoHS Considerations

<http://www.maximintegrated.com/emmi/faq.cfm>

Reliability Information:

<http://www.maximintegrated.com/reliability/product/MAX9995.pdf>

Package Information

For the latest package outline information and land patterns (footprints), go to www.maximintegrated.com/packages. Note that a "+", "#", or "-" in the package code indicates RoHS status only. Package drawings may show a different suffix character, but the drawing pertains to the package regardless of RoHS status.

PACKAGE TYPE	PACKAGE CODE	OUTLINE NO.	LAND PATTERN NO.
36 TQFN-EP	T3666+2	21-0141	90-0049

Typical Application Circuit

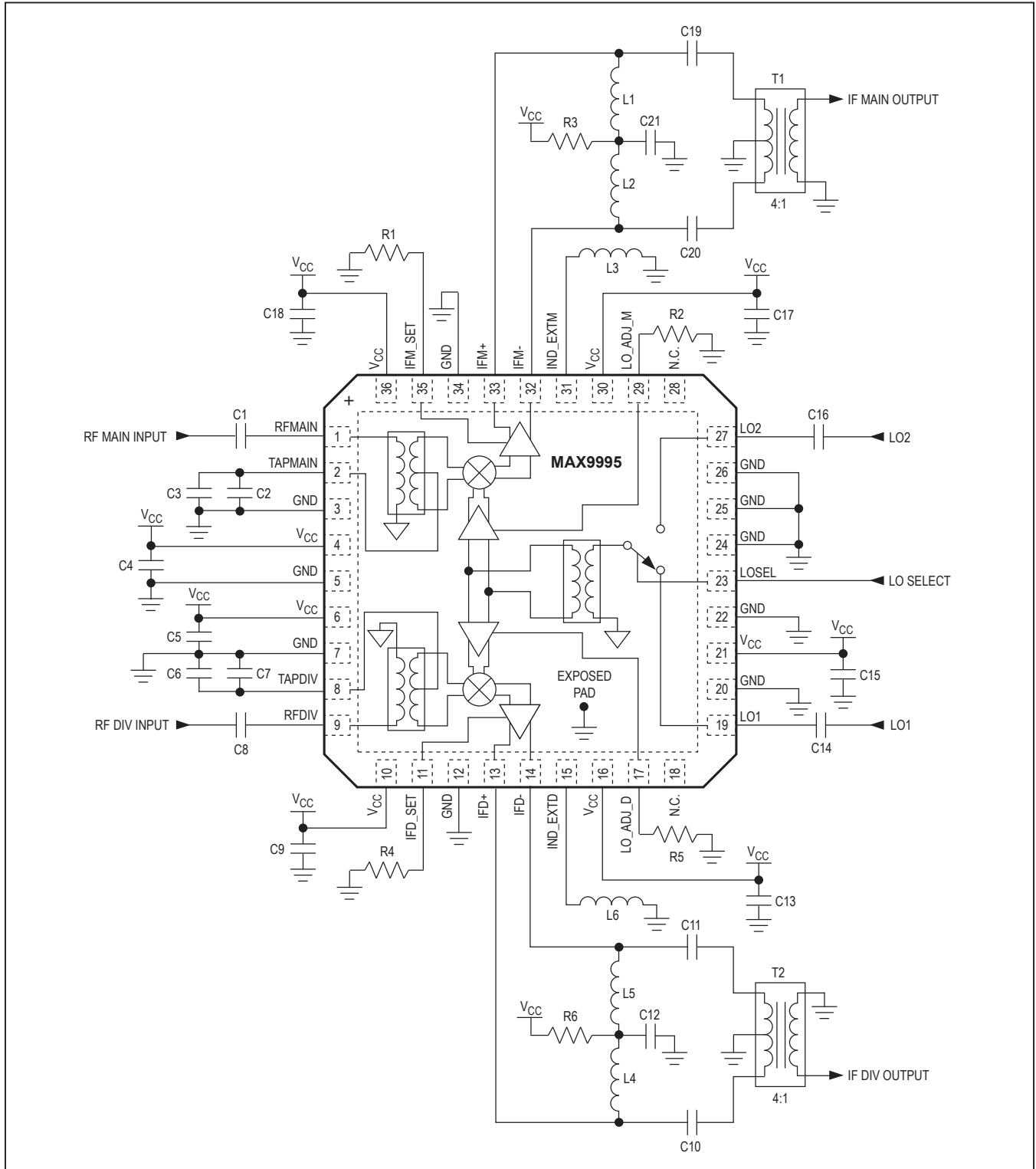

MAX9995

Dual, SiGe, High-Linearity, 1700MHz to 2700MHz
Downconversion Mixer with LO Buffer/Switch

Revision History

REVISION NUMBER	REVISION DATE	DESCRIPTION	PAGES CHANGED
0	8/04	Initial release	—
1	3/11	Updated the band coverage throughout the data sheet	1–13
2	12/12	Updated the <i>Electrical Characteristic</i> table and <i>Ordering Information</i> ; updated <i>Package Thermal Characteristics</i>	1, 2, 3
3	1/21	Updated the Package Information table.	11



Information furnished by Analog Devices is believed to be accurate and reliable. However, no responsibility is assumed by Analog Devices for its use, nor for any infringements of patents or other rights of third parties that may result from its use. Specifications subject to change without notice. No license is granted by implication or otherwise under any patent or patent rights of Analog Devices. Trademarks and registered trademarks are the property of their respective owners.