

Power MOSFET

PRODUCT SUMMARY		
V_{DS} (V)	500	
$R_{DS(on)}$ (Ω)	$V_{GS} = 10\text{ V}$	0.320
Q_g (Max.) (nC)	92	
Q_{gs} (nC)	24	
Q_{gd} (nC)	44	
Configuration	Single	

TO-220 FULLPAK

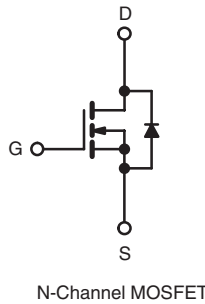
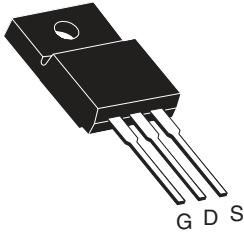

FEATURES

- Super Fast Body Diode Eliminates the Need for External Diodes in ZVS Applications
- Lower Gate Charge Results in Simpler Drive Requirements
- Enhanced dV/dt Capabilities Offer Improved Ruggedness
- Higher Gate Voltage Threshold Offers Improved Noise Immunity
- Lead (Pb)-free



APPLICATIONS

- Zero Voltage Switching SMPS
- Telecom and Server Power Supplies
- Uninterruptible Power Supplies
- Motor Control Applications

ORDERING INFORMATION	
Package	TO-220 FULLPAK
Lead (Pb)-free	IRFIB7N50LPbF
	SiHFIB7N50L-E3

ABSOLUTE MAXIMUM RATINGS $T_C = 25\text{ }^\circ\text{C}$, unless otherwise noted				
PARAMETER	SYMBOL	LIMIT	UNIT	
Drain-Source Voltage	V_{DS}	500	V	
Gate-Source Voltage	V_{GS}	± 30		
Continuous Drain Current	V_{GS} at 10 V	$T_C = 25\text{ }^\circ\text{C}$	A	
		$T_C = 100\text{ }^\circ\text{C}$		
Pulsed Drain Current ^a	I_{DM}	27		
Linear Derating Factor		0.37	W/ $^\circ\text{C}$	
Single Pulse Avalanche Energy ^b	E_{AS}	550	mJ	
Avalanche Current ^a	I_{AR}	6.8	A	
Repetitive Avalanche Energy ^a	E_{AR}	4.6	mJ	
Maximum Power Dissipation	$T_C = 25\text{ }^\circ\text{C}$	P_D	46	W
Peak Diode Recovery dV/dt^c	dV/dt	24	V/ns	
Operating Junction and Storage Temperature Range	T_J, T_{stg}	- 55 to + 150	$^\circ\text{C}$	
Soldering Recommendations (Peak Temperature)	for 10 s	300 ^d		
Mounting Torque	6-32 or M3 screw	10	lbf · in	
		1.1	N · m	

Notes

- Repetitive rating; pulse width limited by maximum junction temperature (see fig. 12).
- Starting $T_J = 25\text{ }^\circ\text{C}$, $L = 24\text{ mH}$, $R_G = 25\text{ }\Omega$, $I_{AS} = 6.8\text{ A}$ (see fig. 14).
- $I_{SD} \leq 6.8\text{ A}$, $dI/dt \leq 650\text{ A}/\mu\text{s}$, $V_{DD} \leq V_{DS}$, $dV/dt = 24\text{ V/ns}$, $T_J \leq 150\text{ }^\circ\text{C}$.
- 1.6 mm from case.

THERMAL RESISTANCE RATINGS				
PARAMETER	SYMBOL	TYP.	MAX.	UNIT
Maximum Junction-to-Ambient	R_{thJA}	-	65	°C/W
Maximum Junction-to-Case (Drain)	R_{thJC}	-	2.69	

SPECIFICATIONS $T_J = 25\text{ }^\circ\text{C}$, unless otherwise noted							
PARAMETER	SYMBOL	TEST CONDITIONS	MIN.	TYP.	MAX.	UNIT	
Static							
Drain-Source Breakdown Voltage	V_{DS}	$V_{GS} = 0\text{ V}$, $I_D = 250\text{ }\mu\text{A}$	500	-	-	V	
V_{DS} Temperature Coefficient	$\Delta V_{DS}/T_J$	Reference to $25\text{ }^\circ\text{C}$, $I_D = 1\text{ mA}$	-	0.44	-	V/°C	
Gate-Source Threshold Voltage	$V_{GS(th)}$	$V_{DS} = V_{GS}$, $I_D = 250\text{ }\mu\text{A}$	3.0	-	5.0	V	
Gate-Source Leakage	I_{GSS}	$V_{GS} = \pm 30\text{ V}$	-	-	± 100	nA	
Zero Gate Voltage Drain Current	I_{DSS}	$V_{DS} = 500\text{ V}$, $V_{GS} = 0\text{ V}$	-	-	50	μA	
		$V_{DS} = 400\text{ V}$, $V_{GS} = 0\text{ V}$, $T_J = 125\text{ }^\circ\text{C}$	-	-	2.0	mA	
Drain-Source On-State Resistance	$R_{DS(on)}$	$V_{GS} = 10\text{ V}$, $I_D = 4.1\text{ A}^b$	-	0.32	0.38	Ω	
Forward Transconductance	g_{fs}	$V_{DS} = 50\text{ V}$, $I_D = 4.1\text{ A}$	4.7	-	-	S	
Dynamic							
Input Capacitance	C_{iss}	$V_{GS} = 0\text{ V}$, $V_{DS} = 25\text{ V}$, $f = 1.0\text{ MHz}$, see fig. 5	-	2220	-	pF	
Output Capacitance	C_{oss}		-	230	-		
Reverse Transfer Capacitance	C_{rss}		-	23	-		
Output Capacitance	C_{oss}	$V_{GS} = 0\text{ V}$	$V_{DS} = 1.0\text{ V}$, $f = 1.0\text{ MHz}$	-	2780	-	
Effective Output Capacitance	$C_{oss\text{ eff.}}$		$V_{DS} = 400\text{ V}$, $f = 1.0\text{ MHz}$	-	63	-	
Effective Output Capacitance (Energy Related)	$C_{oss\text{ eff. (ER)}}$	$V_{DS} = 0\text{ V to } 400\text{ V}^c$	-	140	-		
Total Gate Charge	Q_g	$V_{GS} = 10\text{ V}$	$I_D = 6.8\text{ A}$, $V_{DS} = 400\text{ V}$, see fig. 7 and 16 ^b	-	-	92	nC
Gate-Source Charge	Q_{gs}			-	-	24	
Gate-Drain Charge	Q_{gd}			-	-	44	
Internal Gate Resistance	R_G	$f = 1\text{ MHz}$, open drain		-	0.88	-	Ω
Turn-On Delay Time	$t_{d(on)}$	$V_{GS} = 10\text{ V}$	$V_{DD} = 250\text{ V}$, $I_D = 6.8\text{ A}$, $R_G = 9.0\text{ }\Omega$, see fig. 11a and 11b ^b	-	23	-	ns
Rise Time	t_r			-	36	-	
Turn-Off Delay Time	$t_{d(off)}$			-	47	-	
Fall Time	t_f			-	19	-	
Drain-Source Body Diode Characteristics							
Continuous Source-Drain Diode Current	I_S	MOSFET symbol showing the integral reverse p - n junction diode 	-	-	6.8	A	
Pulsed Diode Forward Current ^a	I_{SM}		-	-	27		
Body Diode Voltage	V_{SD}	$T_J = 25\text{ }^\circ\text{C}$, $I_S = 6.8\text{ A}$, $V_{GS} = 0\text{ V}^b$	-	-	1.5	V	
Body Diode Reverse Recovery Time	t_{rr}	$T_J = 25\text{ }^\circ\text{C}$, $I_F = 6.8\text{ A}$, $T_J = 125\text{ }^\circ\text{C}$, $di/dt = 100\text{ A}/\mu\text{s}^b$	-	85	130	ns	
			-	130	200		
Body Diode Reverse Recovery Charge	Q_{rr}	$T_J = 25\text{ }^\circ\text{C}$, $I_S = 6.8\text{ A}$, $T_J = 125\text{ }^\circ\text{C}$, $di/dt = 100\text{ A}/\mu\text{s}^b$	-	280	420	nC	
			-	570	860		
Drain-Source Body Diode Characteristics							
Body Diode Reverse Recovery Current	I_{RRM}	$T_J = 25\text{ }^\circ\text{C}$	-	5.9	8.9	A	
Forward Turn-On Time	t_{on}	Intrinsic turn-on time is negligible (turn-on is dominated by L_S and L_D)					

Notes

- Repetitive rating; pulse width limited by maximum junction temperature (see fig. 12).
- Pulse width $\leq 300\text{ }\mu\text{s}$; duty cycle $\leq 2\%$.
- $C_{oss\text{ eff.}}$ is a fixed capacitance that gives the same charging time as C_{oss} while V_{DS} is rising from 0 % to 80 % V_{DS} .
 $C_{oss\text{ eff. (ER)}}$ is a fixed capacitance that stores the same energy as C_{oss} while V_{DS} is rising from 0 % to 80 % V_{DS} .

TYPICAL CHARACTERISTICS 25 °C, unless otherwise noted

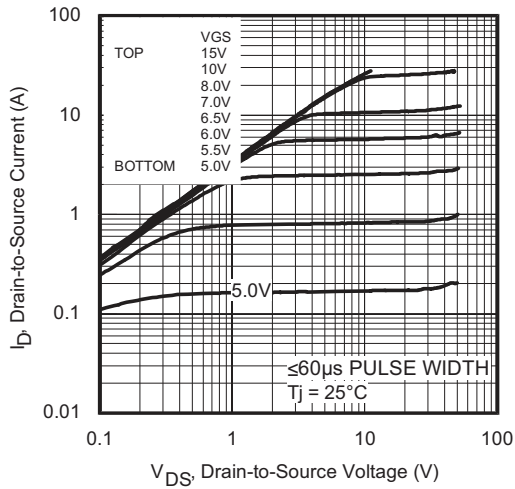

Fig. 1 - Typical Output Characteristics

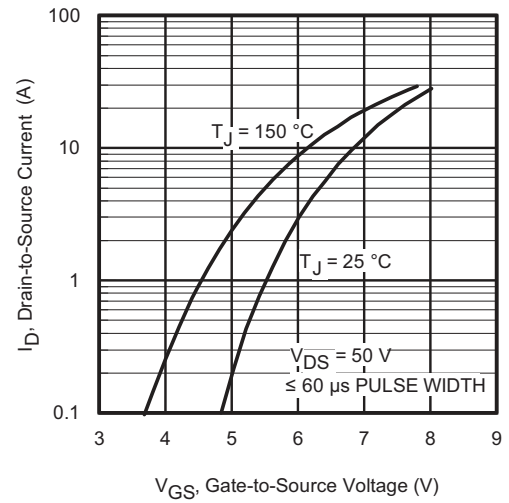

Fig. 3 - Typical Transfer Characteristics

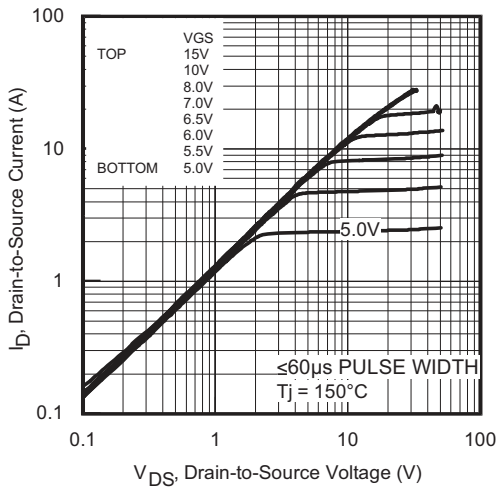

Fig. 2 - Typical Output Characteristics

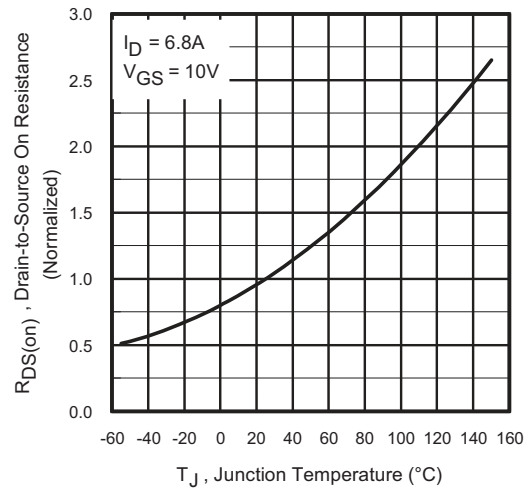

Fig. 4 - Normalized On-Resistance vs. Temperature

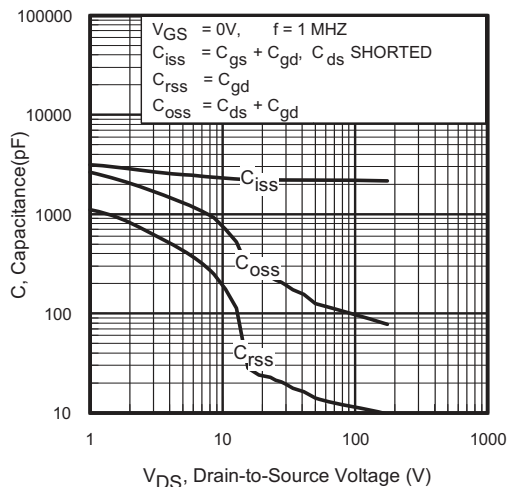

Fig. 5 - Typical Capacitance vs. Drain-to-Source Voltage

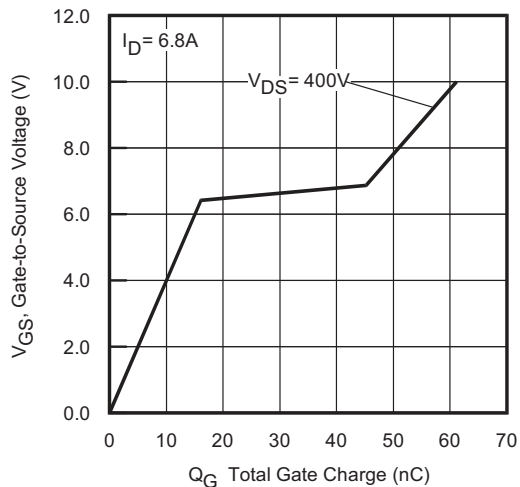

Fig. 7 - Typical Gate Charge vs. Gate-to-Source Voltage

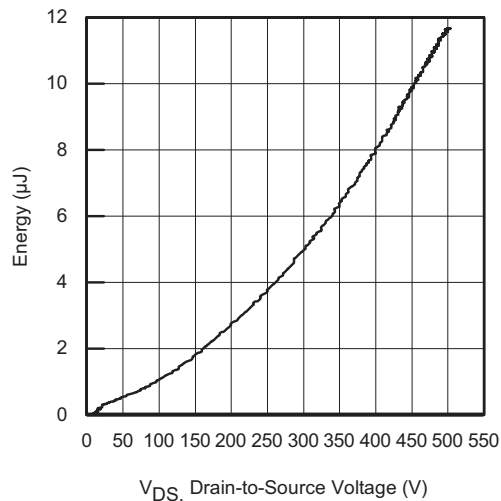

Fig. 6 - Typical Output Capacitance Stored Energy vs. V_{DS}

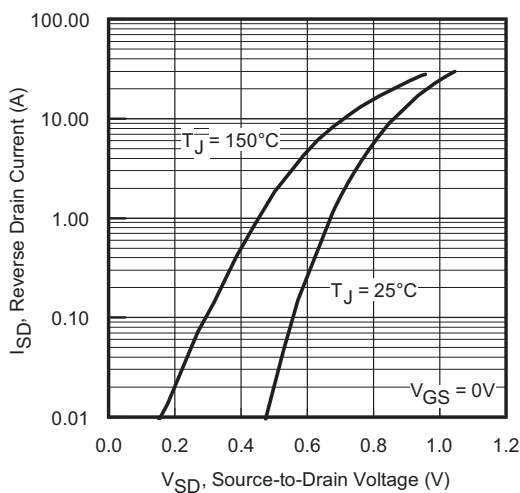

Fig. 8 - Typical Source-Drain Diode Forward Voltage

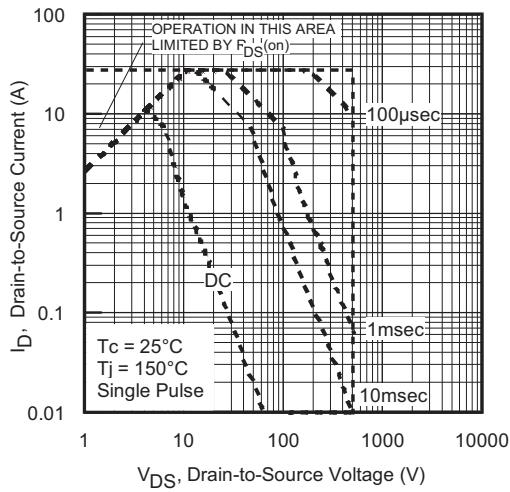

Fig. 9 - Maximum Safe Operating Area

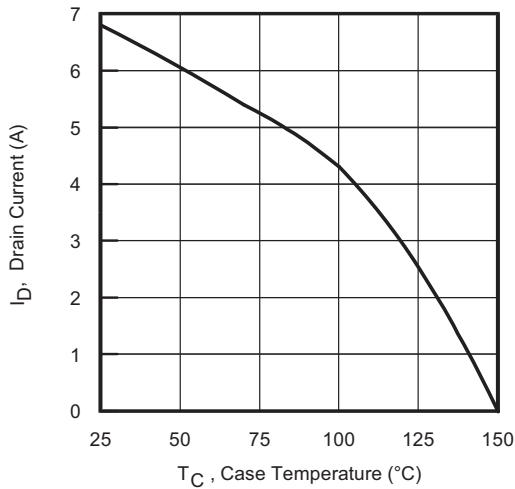

Fig. 10 - Maximum Drain Current vs. Case Temperature

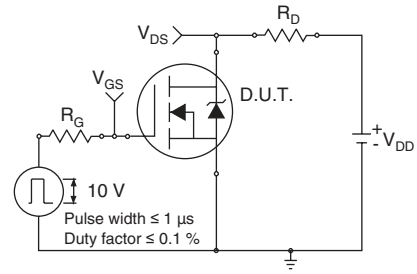

Fig. 11a - Switching Time Test Circuit

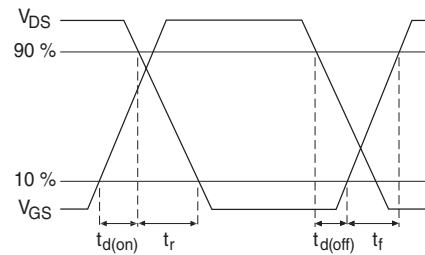

Fig. 11b - Switching Time Waveforms

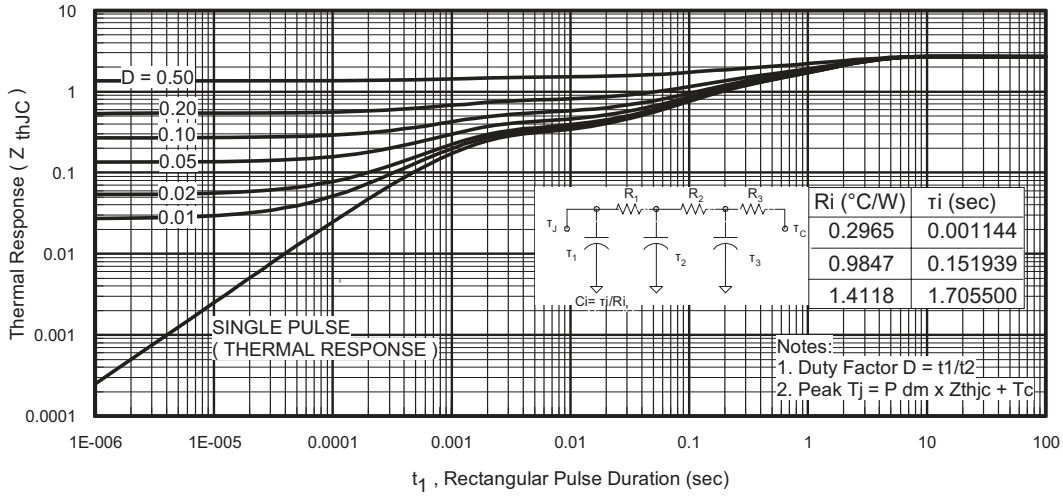

Fig. 12 - Maximum Effective Transient Thermal Impedance, Junction-to-Case

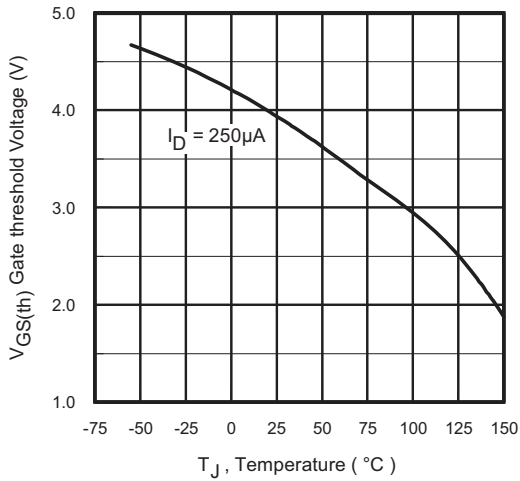

Fig. 13 - Threshold Voltage vs. Temperature

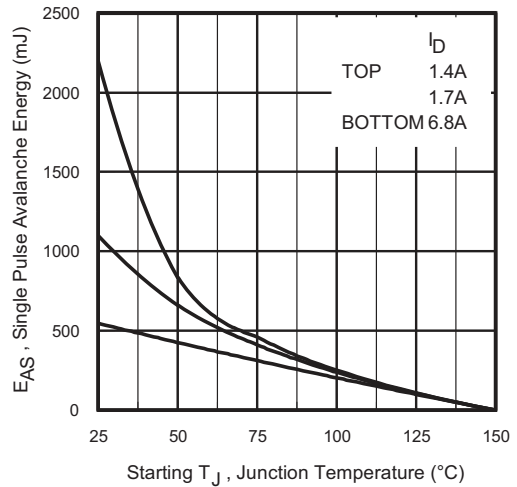

Fig. 14 - Maximum Avalanche Energy vs. Drain Current

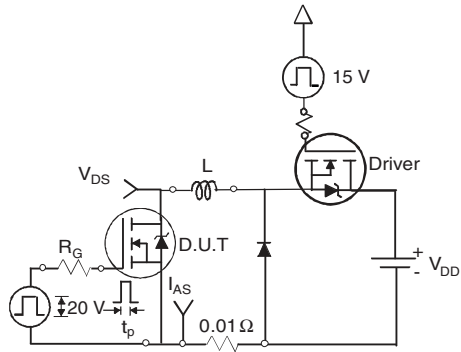

Fig. 15a - Unclamped Inductive Test Circuit

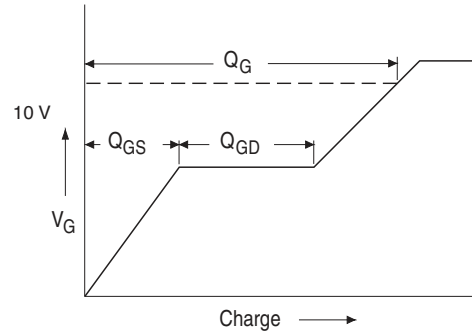

Fig. 16a - Basic Gate Charge Waveform

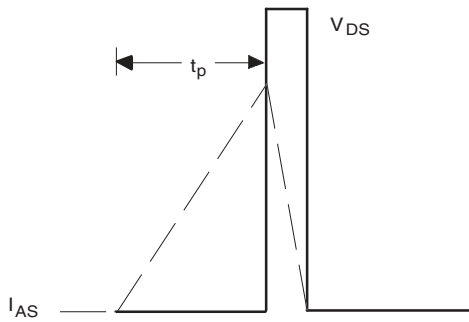

Fig. 15b - Unclamped Inductive Waveforms

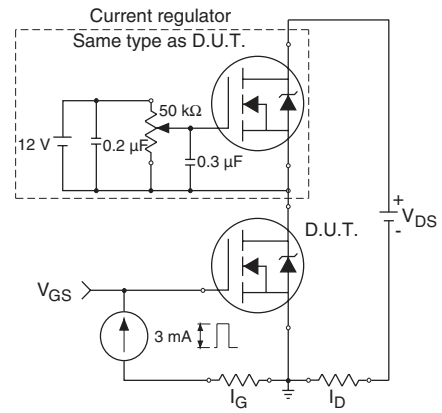
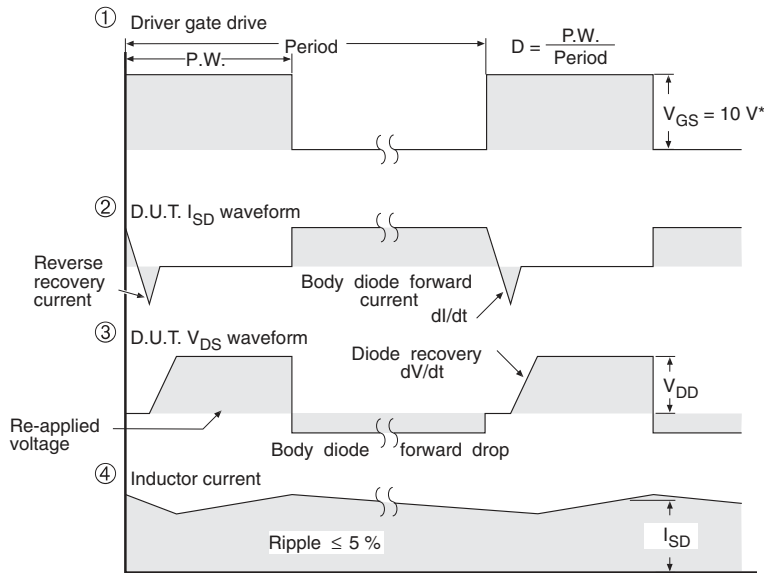
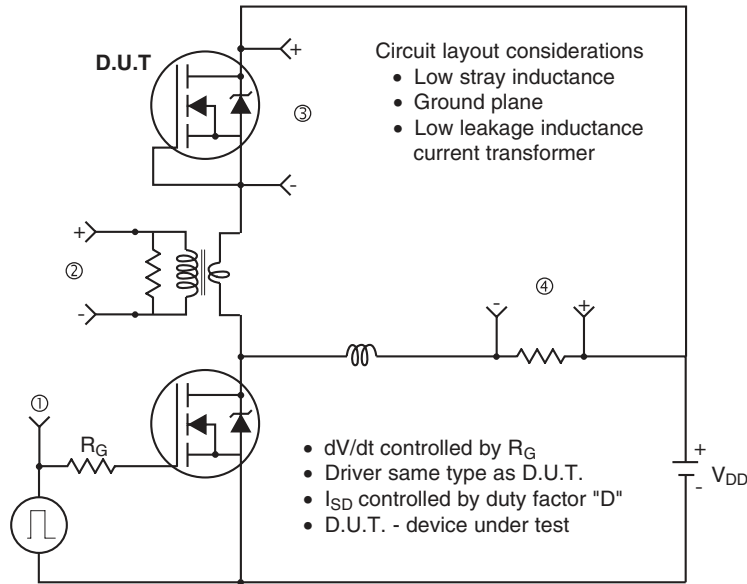

Fig. 16b - Gate Charge Test Circuit

Peak Diode Recovery dV/dt Test Circuit



* $V_{GS} = 5 V$ for logic level devices

Fig. 17 - For N-Channel

Vishay Siliconix maintains worldwide manufacturing capability. Products may be manufactured at one of several qualified locations. Reliability data for Silicon Technology and Package Reliability represent a composite of all qualified locations. For related documents such as package/tape drawings, part marking, and reliability data, see www.vishay.com/ppg?91177.



Disclaimer

All product specifications and data are subject to change without notice.

Vishay Intertechnology, Inc., its affiliates, agents, and employees, and all persons acting on its or their behalf (collectively, "Vishay"), disclaim any and all liability for any errors, inaccuracies or incompleteness contained herein or in any other disclosure relating to any product.

Vishay disclaims any and all liability arising out of the use or application of any product described herein or of any information provided herein to the maximum extent permitted by law. The product specifications do not expand or otherwise modify Vishay's terms and conditions of purchase, including but not limited to the warranty expressed therein, which apply to these products.

No license, express or implied, by estoppel or otherwise, to any intellectual property rights is granted by this document or by any conduct of Vishay.

The products shown herein are not designed for use in medical, life-saving, or life-sustaining applications unless otherwise expressly indicated. Customers using or selling Vishay products not expressly indicated for use in such applications do so entirely at their own risk and agree to fully indemnify Vishay for any damages arising or resulting from such use or sale. Please contact authorized Vishay personnel to obtain written terms and conditions regarding products designed for such applications.

Product names and markings noted herein may be trademarks of their respective owners.