

EP17 LM259X Inductor  
68 uHy 3.25 ADC

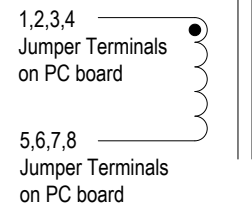
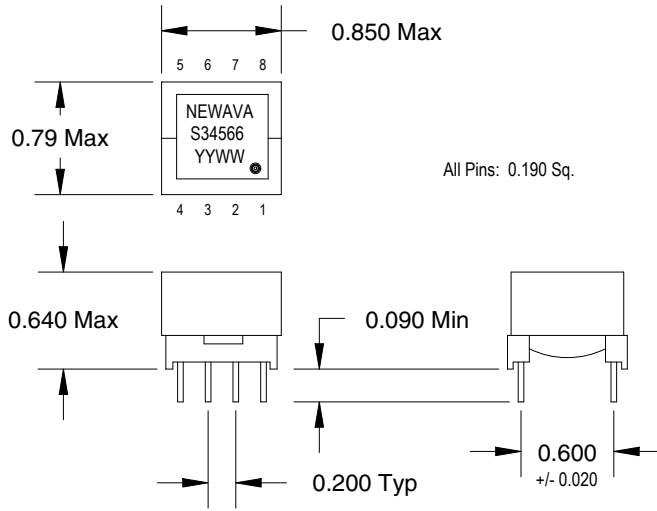

ELECTRICAL SPECS:

- 1: INDUCTANCE: @ 10 kHz, 0.1 Vrms  
(1 thru 4 to 5 thru 8) = 68 - 88 uHy
- 2: DCRs:  
(1 thru 4 to 5 thru 8) = 0.045 Ohms Max.
- 3: SRF: 2.0 MHz Min
- 4: HIPOT: 500 VDC  
Winding to core (2 Sec., 5 mA Max)

All pins may not be used.  
Specifications at room temperature of 25 C.

A	2/28/03		KAM	Production Release	
REV.	DATE	ECN	BY	DESCRIPTION	
TOLERANCES ON			<b>Newava Tech.</b> Watertown, SD 57201 605-886-0264		
.XXX	.XX	ANGLE			
+ -	+ -	+ -	DATE	DRAWING NO.	REV.
DRAWN:			SCALE	MODEL	
CHECKED: -					
APPROVED: -			- KAM	NEXT ASSY:	
THIS PRINT MUST NOT BE COPIED IN WHOLE OR IN PART				OR USED DETRIMENTALLY TO OUR INTEREST	
					SHEET 1 OF 1