



GAAS PHEMT MMIC LOW NOISE AMPLIFIER, 3.1 - 3.9GHz

Typical Applications

The HMC716LP3E is ideal for:

- Fixed Wireless and LTE/WiMAX/4G
- BTS & Infrastructure
- Repeaters and Femtocells
- Public Safety Radio
- Access Points

Features

- Noise Figure: 1 dB
- Gain: 18 dB
- Output IP3: +33 dBm
- Single Supply: +3V to +5V
- 50 Ohm Matched Input/Output
- 16 Lead 3x3mm QFN Package: 9 mm²

Functional Diagram

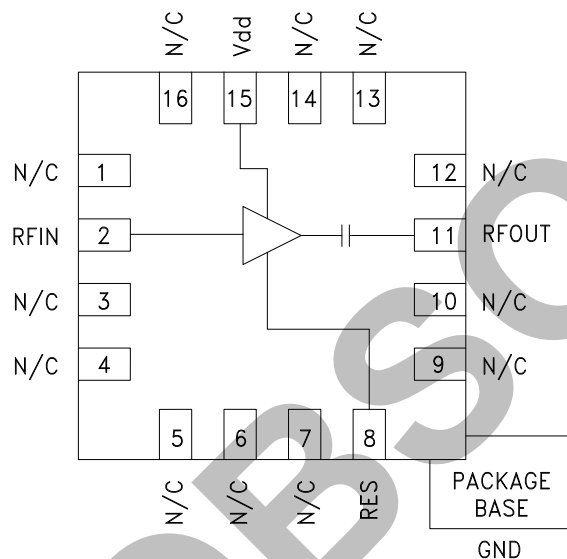

General Description

The HMC716LP3E is a GaAs pHEMT MMIC Low Noise Amplifier that is ideal for fixed wireless and LTE/WiMAX/4G basestation front-end receivers operating between 3.1 and 3.9 GHz. The amplifier has been optimized to provide 1 dB noise figure, 18 dB gain and +33 dBm output IP3 from a single supply of +5V. Input and output return losses are excellent and the LNA requires minimal external matching and bias decoupling components. The HMC716LP3E can be biased with +3V to +5V and features an externally adjustable supply current which allows the designer to tailor the linearity performance of the LNA for each application.

Electrical Specifications

$T_A = +25^\circ\text{C}$, $R_{bias} = 820\Omega$ for $V_{dd} = 5V$, $R_{bias} = 47k\Omega$ for $V_{dd} = 3V$ [1]

Parameter	Vdd = +3V			Vdd = +5V			Units
	Min.	Typ.	Max.	Min.	Typ.	Max.	
Frequency Range	3.1 - 3.9			3.1 - 3.9			MHz
Gain	13	17		15.5	18		dB
Gain Variation Over Temperature		0.01			0.01		dB/°C
Noise Figure		1	1.3		1	1.3	dB
Input Return Loss		25			30		dB
Output Return Loss		13			16		dB
Output Power for 1 dB Compression (P1dB)	12	15		16	19		dBm
Saturated Output Power (Psat)		16.5			20.5		dBm
Output Third Order Intercept (IP3)		26			33		dBm
Supply Current (Idd)		41	55		65	90	mA

[1] Rbias resistor sets current, see application circuit herein



**GAAS PHEMT MMIC LOW NOISE
AMPLIFIER, 3.1 - 3.9GHz**

Broadband Gain & Return Loss [1] [2]

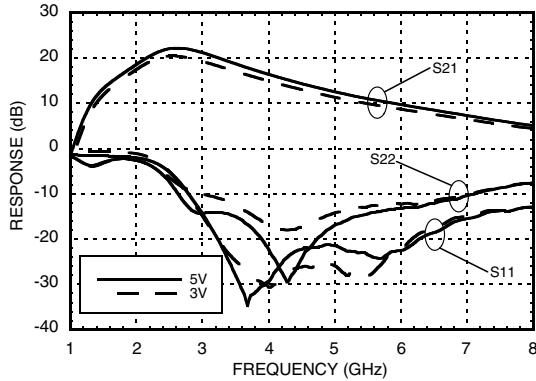

Gain vs. Temperature [1]

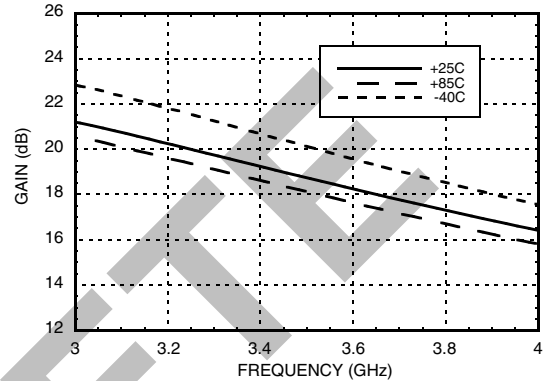

Gain vs. Temperature [2]

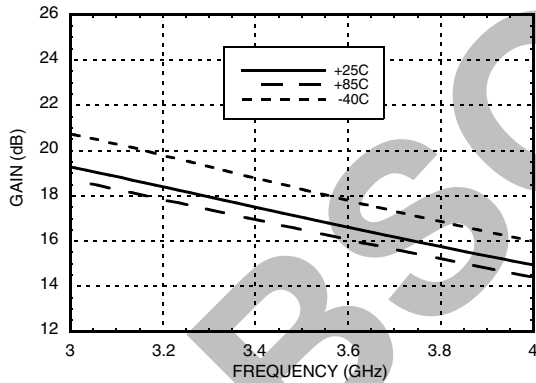

Input Return Loss vs. Temperature [1]

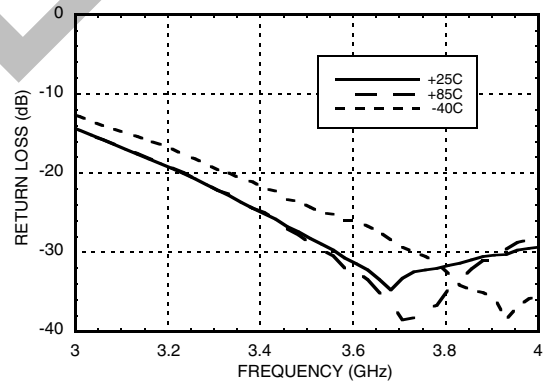

Output Return Loss vs. Temperature [1]

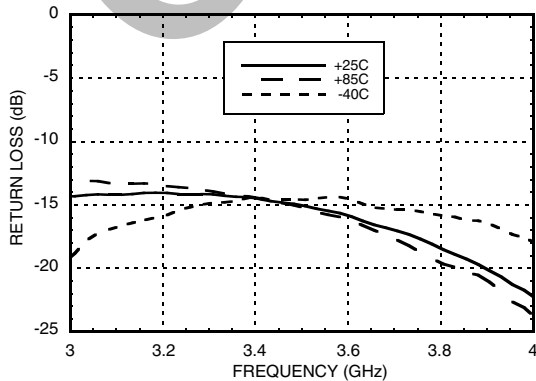

Reverse Isolation vs. Temperature [1]

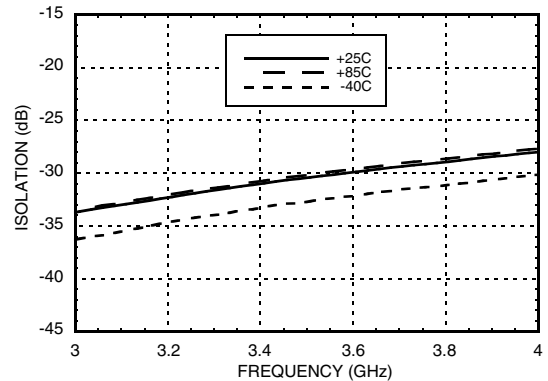

[1] Vdd = 5V, Rbias = 820 Ω [2] Vdd = 3V, Rbias = 47k Ω

Information furnished by Analog Devices is believed to be accurate and reliable. However, no responsibility is assumed by Analog Devices for its use, nor for any infringements of patents or other rights of third parties that may result from its use. Specifications subject to change without notice. No license is granted by implication or otherwise under any patent or patent rights of Analog Devices. Trademarks and registered trademarks are the property of their respective owners.

For price, delivery, and to place orders: Analog Devices, Inc., One Technology Way, P.O. Box 9106, Norwood, MA 02062-9106 Phone: 781-329-4700 • Order online at www.analog.com Application Support: Phone: 1-800-ANALOG-D



**GAAS PHEMT MMIC LOW NOISE
AMPLIFIER, 3.1 - 3.9GHz**

LOW NOISE AMPLIFIERS - SMT

Noise Figure vs. Temperature [1] [2] [4]

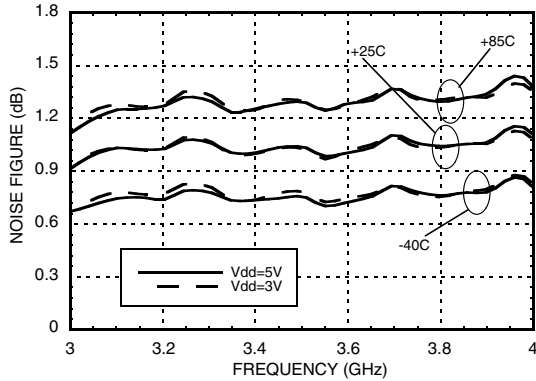

P1dB vs. Temperature [1] [2]

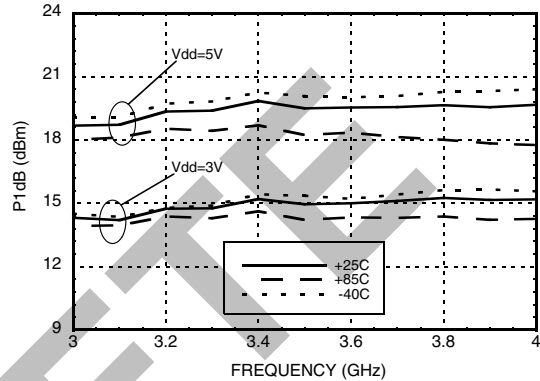

Psat vs. Temperature [1] [2]

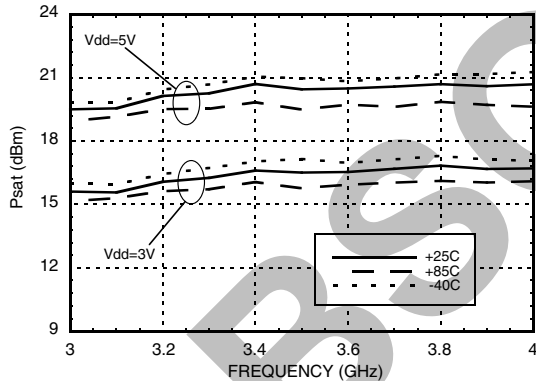

Output IP3 vs. Temperature [1] [2]

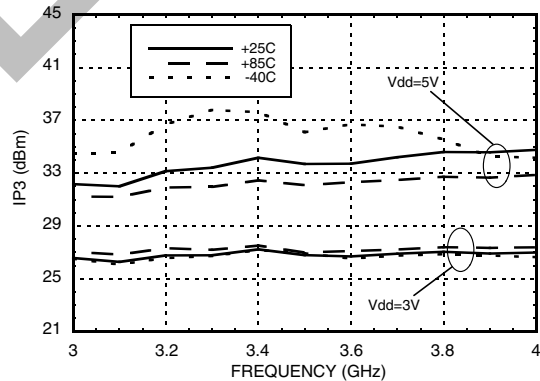

**Output IP3 and Supply Current vs.
Supply Voltage @ 3300 MHz [3]**

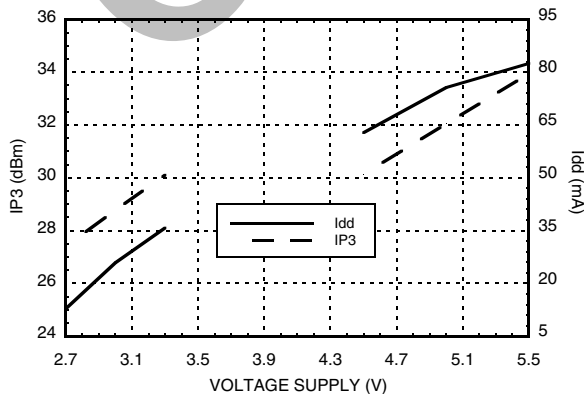

**Output IP3 and Supply Current vs.
Supply Voltage @ 3800 MHz [3]**

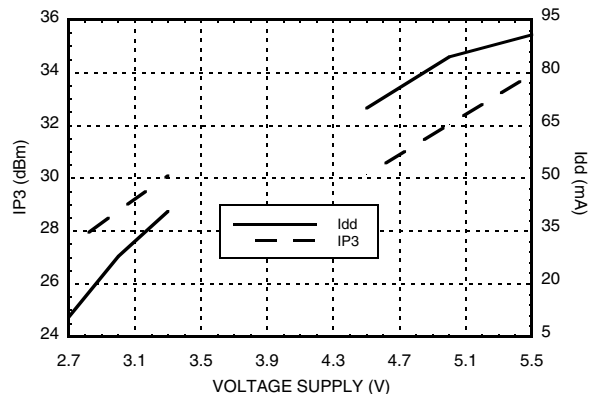

[1] Vdd = 5V, Rbias = 820 Ω [2] Vdd = 3V, Rbias = 47k Ω

[3] Rbias = 820 Ω for Vdd = 5V, Rbias = 47k Ω for Vdd = 3V

[4] Measurement reference plane shown on evaluation PCB drawing.



GAAS PHEMT MMIC LOW NOISE AMPLIFIER, 3.1 - 3.9GHz

Power Compression @ 3300 MHz [1]

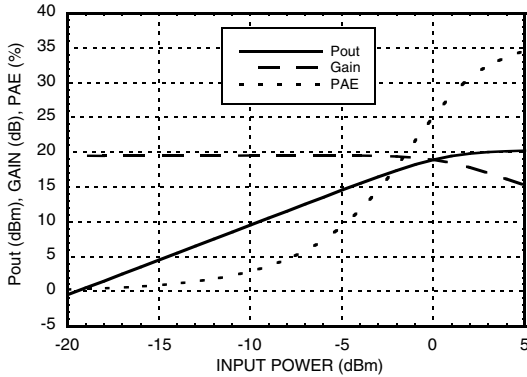

Power Compression @ 3300 MHz [2]

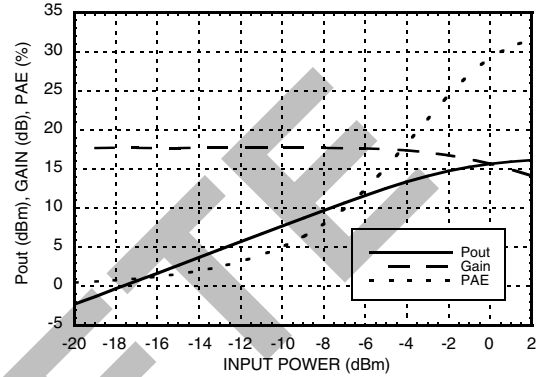

Power Compression @ 3300 MHz [1]

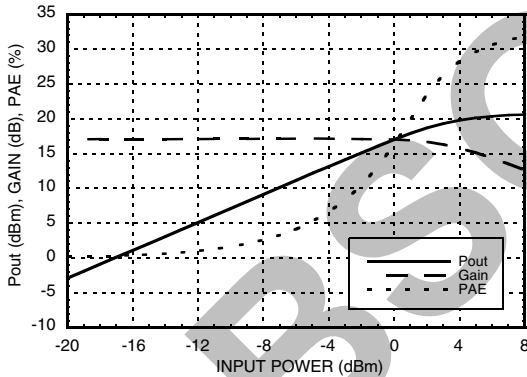

Power Compression @ 3800 MHz [2]

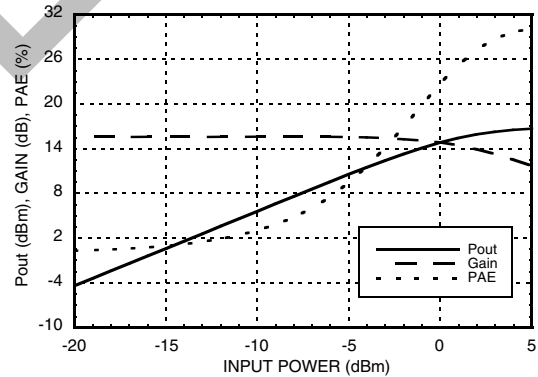

Gain, Power & Noise Figure vs. Supply Voltage @ 3300 MHz [3]

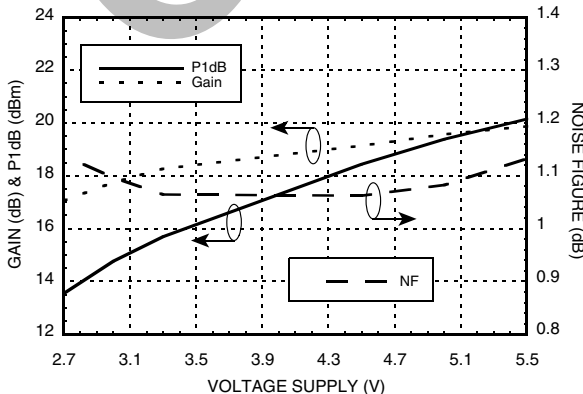

Gain, Power & Noise Figure vs. Supply Voltage @ 3800 MHz [3]

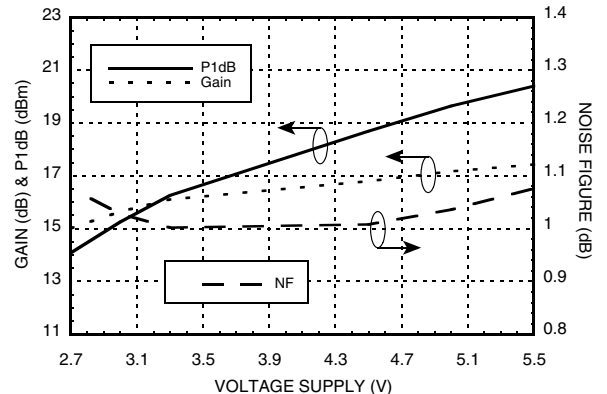

[1] Vdd = 5V, Rbias = 820 Ω [2] Vdd = 3V, Rbias = 47k Ω [3] Rbias = 820 Ω for Vdd = 5V, Rbias = 47k for Vdd 3V

Information furnished by Analog Devices is believed to be accurate and reliable. However, no responsibility is assumed by Analog Devices for its use, nor for any infringements of patents or other rights of third parties that may result from its use. Specifications subject to change without notice. No license is granted by implication or otherwise under any patent or patent rights of Analog Devices. Trademarks and registered trademarks are the property of their respective owners.

For price, delivery, and to place orders: Analog Devices, Inc., One Technology Way, P.O. Box 9106, Norwood, MA 02062-9106 Phone: 781-329-4700 • Order online at www.analog.com Application Support: Phone: 1-800-ANALOG-D



**GAAS PHEMT MMIC LOW NOISE
AMPLIFIER, 3.1 - 3.9GHz**

LOW NOISE AMPLIFIERS - SMT

Output IP3 vs. Rbias @ 3300 MHz

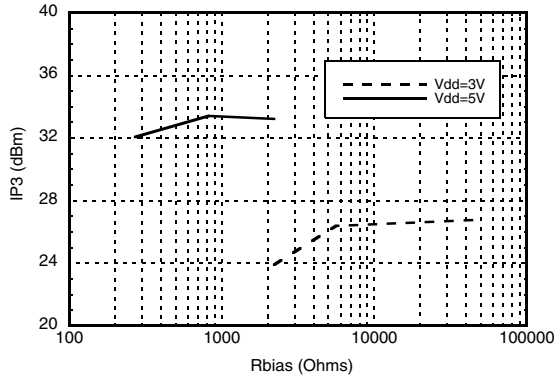

Gain, Noise Figure & Rbias @ 3300 MHz

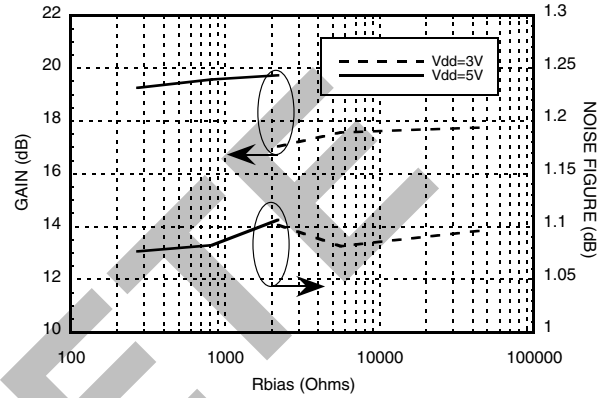

Output IP3 vs. Rbias @ 3800 MHz

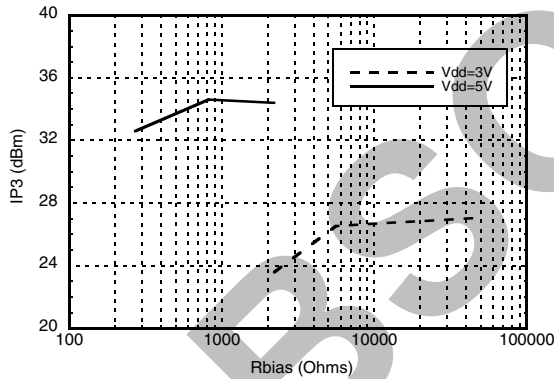

Gain, Noise Figure & Rbias @ 3800 MHz

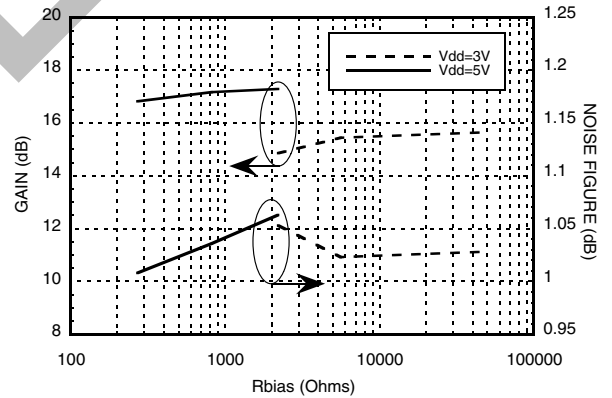

GAAS PHEMT MMIC LOW NOISE AMPLIFIER, 3.1 - 3.9GHz



Absolute Bias Resistor Range & Recommended Bias Resistor Values

Vdd (V)	Rbias (Ω)			Idd (mA)
	Min	Max	Recommended	
3V	2k [1]	Open Circuit	2.2k	20
			5.6k	30
			47k	41
5V	0	Open Circuit	270	48
			820	65
			2.2k	81

[1] With Vdd= 3V and Rbias < 2kΩ may result in the part becoming conditionally stable which is not recommended.

Absolute Maximum Ratings

Drain Bias Voltage (Vdd)	+5.5V
RF Input Power (RFIN) (Vdd = +5 Vdc)	+10 dBm
Channel Temperature	150 °C
Continuous P _{diss} (T= 85 °C) (derate 11.1 mW/°C above 85 °C)	0.72 W
Thermal Resistance (channel to ground paddle)	90 °C/W
Storage Temperature	-65 to +150 °C
Operating Temperature	-40 to +85 °C
ESD Sensitivity (HBM)	Class 1A



ELECTROSTATIC SENSITIVE DEVICE
OBSERVE HANDLING PRECAUTIONS

Typical Supply Current vs. Supply Voltage (Rbias = 820 Ω for Vdd = 5V, Rbias = 47k Ω for Vdd = 3V)

Vdd (V)	Idd (mA)
2.7	31
3.0	41
3.3	51
4.5	51
5.0	65
5.5	80

Note: Amplifier will operate over full voltage ranges shown above.



**GAAS PHEMT MMIC LOW NOISE
AMPLIFIER, 3.1 - 3.9GHz**

Outline Drawing

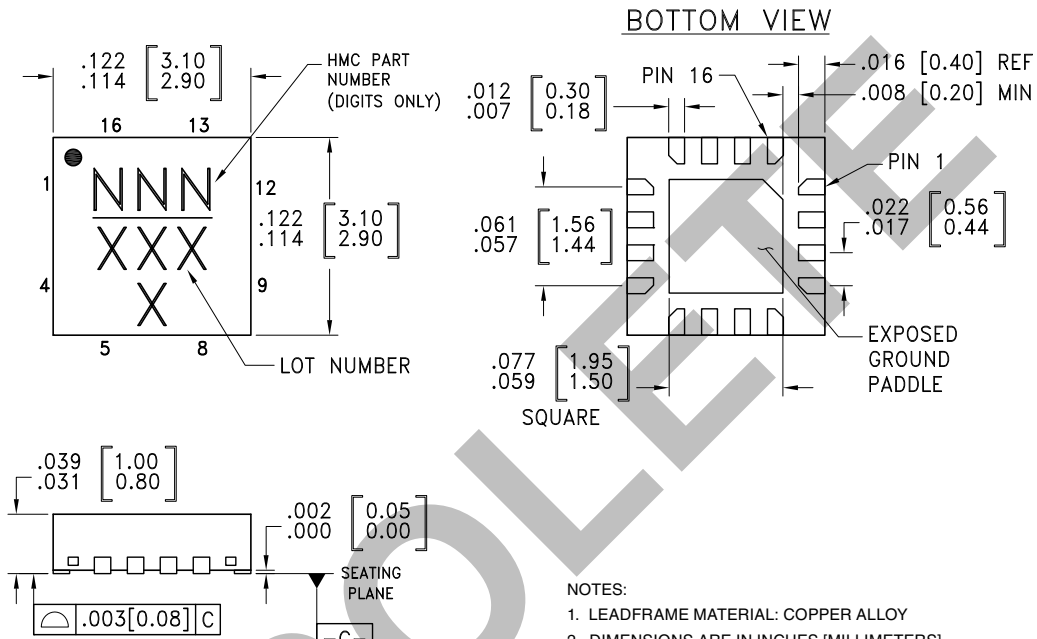

- NOTES:
1. LEADFRAME MATERIAL: COPPER ALLOY
 2. DIMENSIONS ARE IN INCHES [MILLIMETERS]
 3. LEAD SPACING TOLERANCE IS NON-CUMULATIVE
 4. PAD BURR LENGTH SHALL BE 0.15mm MAXIMUM.
PAD BURR HEIGHT SHALL BE 0.05mm MAXIMUM.
 5. PACKAGE WARP SHALL NOT EXCEED 0.05mm.
 6. ALL GROUND LEADS AND GROUND PADDLE MUST BE SOLDERED TO PCB RF GROUND.
 7. REFER TO HITTITE APPLICATION NOTE FOR SUGGESTED LAND PATTERN.

Package Information



Part Number	Package Body Material	Lead Finish	MSL Rating	Package Marking ^[3]
HMC716LP3E	RoHS-compliant Low Stress Injection Molded Plastic	100% matte Sn	MSL1 ^[2]	716 XXXX

[1] Max peak reflow temperature of 235 °C
 [2] Max peak reflow temperature of 260 °C
 [3] 4-Digit lot number XXXX

GAAS PHEMT MMIC LOW NOISE AMPLIFIER, 3.1 - 3.9GHz

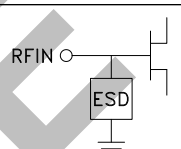
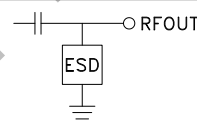
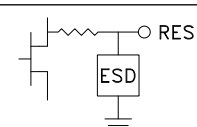
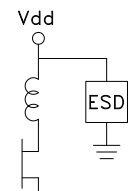

Pin Descriptions

Pin Number	Function	Description	Interface Schematic
1, 3 - 7, 9, 10, 12 - 14, 16	N/C	The pins are not connected internally; however, all data shown herein was measured with these pins connected to RF/DC ground externally.	
2	RFIN	This pin is DC coupled. An off chip DC blocking capacitor is required.	
11	RFOUT	This pin is AC coupled and matched to 50 Ohms.	
8	RES	This pin is used to set the DC current of the amplifier by selection of external bias resistor. See application circuit.	
15	Vdd	Power supply voltage. Bypass capacitors are required. See application circuit.	
	GND	Ground paddle must be connected to RF/DC ground.	



**GAAS PHEMT MMIC LOW NOISE
AMPLIFIER, 3.1 - 3.9GHz**

Application Circuit

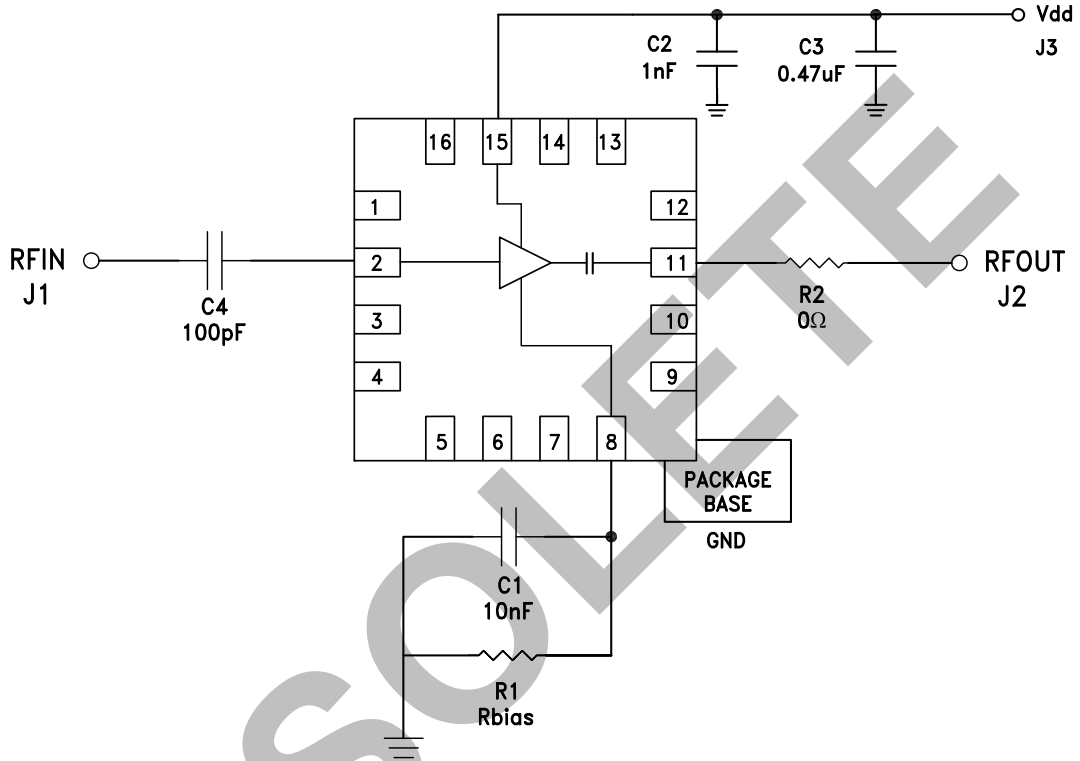

LOW NOISE AMPLIFIERS - SMT



**GAAS PHEMT MMIC LOW NOISE
AMPLIFIER, 3.1 - 3.9GHz**

Evaluation PCB

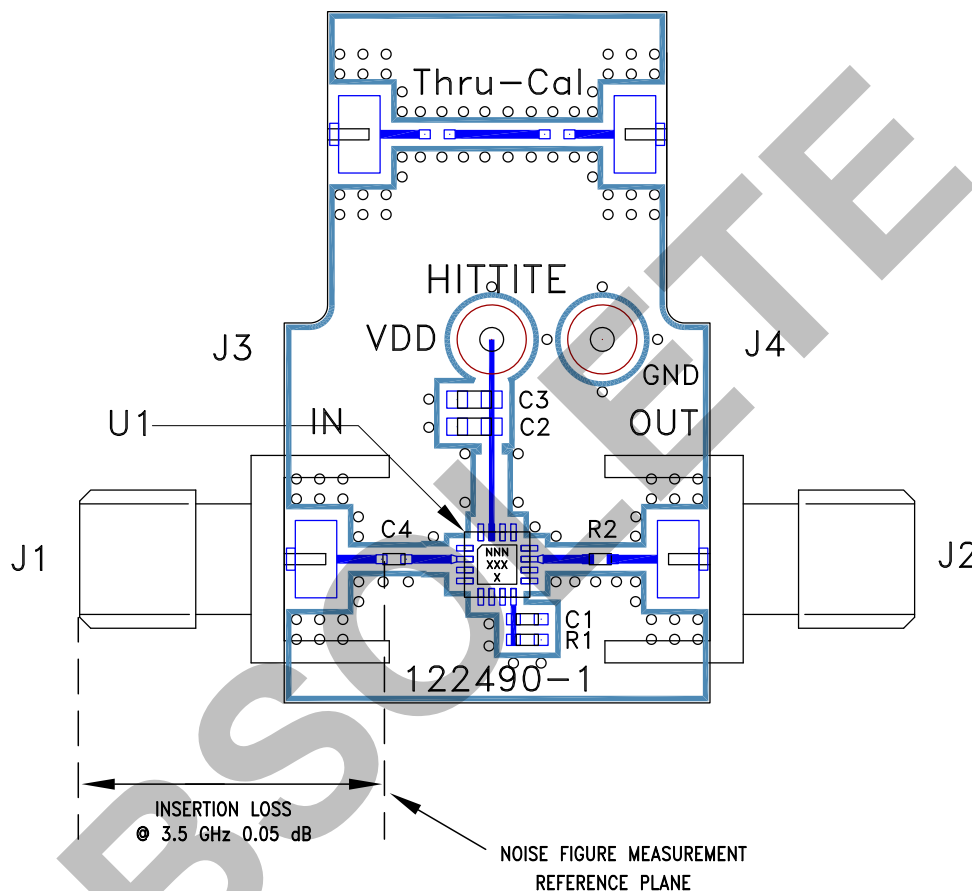

List of Materials for Evaluation PCB 122540 [1]

Item	Description
J1, J2	PCB Mount SMA Connector
J3, J4	DC Pin
C1	10 nF Capacitor, 0402 Pkg.
C2	1000 pF Capacitor, 0603 Pkg.
C3	0.47 μF Capacitor, 0603 Pkg.
C4	100 pF Capacitor, 0402 Pkg.
R1	820Ω Resistor, 0402 Pkg.
R2	0 Ohm Resistor, 0402 Pkg.
U1	HMC716LP3E Amplifier
PCB [2]	122490 Evaluation PCB

[1] Reference this number when ordering complete evaluation PCB

[2] Circuit Board Material: Rogers 4350 or Arlon 25FR

The circuit board used in this application should use RF circuit design techniques. Signal lines should have 50 Ohm impedance while the package ground leads and exposed paddle should be connected directly to the ground plane similar to that shown. A sufficient number of via holes should be used to connect the top and bottom ground planes. The evaluation board should be mounted to an appropriate heat sink. The evaluation circuit board shown is available from Hittite upon request.