

Base strip - FK-MPT 0,5/14-IC-3,5 - 1905463

Please be informed that the data shown in this PDF Document is generated from our Online Catalog. Please find the complete data in the user's documentation. Our General Terms of Use for Downloads are valid (<http://phoenixcontact.com/download>)



Header, Nominal current: 3 A, Rated voltage (III/2): 250 V, Number of positions: 14, Pitch: 3.5 mm, Color: green, Contact surface: Tin, Assembly: Soldering, The touch-protected basic strip, serves to accommodate the FK-MPT 0,5 PCB terminal block.

The illustration shows a 15-position version



Key commercial data

Packing unit	1 pc
Minimum order quantity	50 pc
Weight per Piece (excluding packing)	3.05 GRM
Custom tariff number	85366990
Country of origin	Germany

Technical data

Dimensions

Length	8.8 mm
Pitch	3.5 mm
Dimension a	45.5 mm
Pin dimensions	0,3 x 0,9 mm
Pin spacing	3.50 mm
Hole diameter	1 mm

General

Range of articles	FK-MPT 0,5/..-IC
Insulating material group	IIIa
Rated surge voltage (III/3)	2.5 kV
Rated surge voltage (III/2)	2.5 kV
Rated surge voltage (II/2)	2.5 kV
Rated voltage (III/3)	160 V

Base strip - FK-MPT 0,5/14-IC-3,5 - 1905463

Technical data

General

Rated voltage (III/2)	250 V
Rated voltage (II/2)	250 V
Connection in acc. with standard	EN-VDE
Nominal current I _N	3 A
Maximum load current	3 A
Insulating material	PA
Inflammability class according to UL 94	V0
Color	green
Number of positions	14

Classifications

eCl@ss

eCl@ss 4.0	272607xx
eCl@ss 4.1	27260701
eCl@ss 5.0	27260701
eCl@ss 5.1	27260701
eCl@ss 6.0	27260704
eCl@ss 7.0	27440402
eCl@ss 8.0	27440402

ETIM

ETIM 3.0	EC001121
ETIM 4.0	EC002637
ETIM 5.0	EC002637

UNSPSC

UNSPSC 6.01	30211801
UNSPSC 7.0901	39121432
UNSPSC 11	34131203
UNSPSC 12.01	39121432
UNSPSC 13.2	39121432

Approvals

Approvals

Base strip - FK-MPT 0,5/14-IC-3,5 - 1905463

Approvals

Approvals

UL Recognized / cUL Recognized / GOST / GOST / cULus Recognized

Ex Approvals

Approvals submitted

Approval details

UL Recognized		
	B	D
Nominal current I _N	4 A	4 A
Nominal voltage U _N	300 V	300 V

cUL Recognized		
	B	D
Nominal current I _N	4 A	4 A
Nominal voltage U _N	300 V	300 V

GOST	
------	--

GOST	
------	--

cULus Recognized	
------------------	--

Drawings

Base strip - FK-MPT 0,5/14-IC-3,5 - 1905463

Drilling diagram

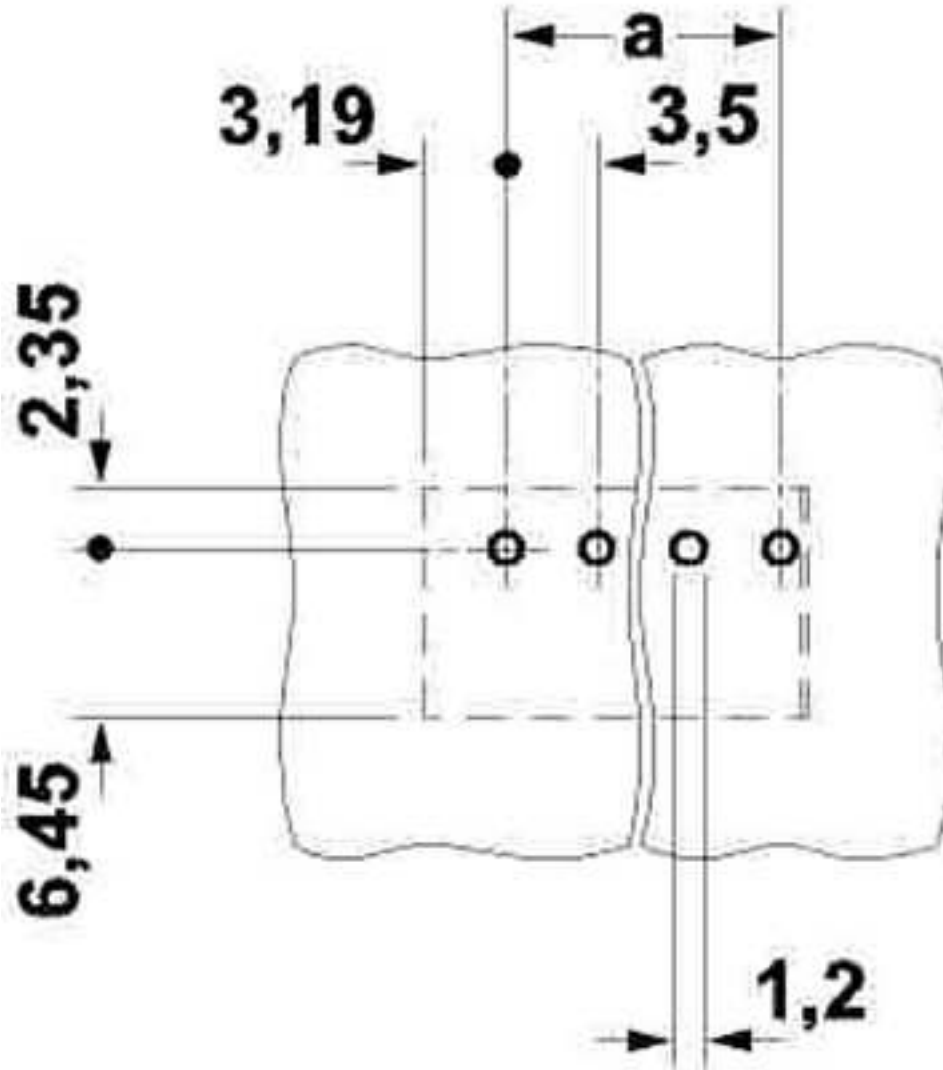

Base strip - FK-MPT 0,5/14-IC-3,5 - 1905463

Dimensioned drawing

