

Click [here](#) to ask about the production status of specific part numbers.

## MAX17503

# 4.5V-60V, 2.5A, High-Efficiency, Synchronous Step-Down DC-DC Converter With Internal Compensation

### General Description

The Himalaya series of voltage regulator ICs, power modules, and chargers enable cooler, smaller, and simpler power supply solutions. The MAX17503/MAX17503S high-efficiency, high-voltage, synchronously rectified step-down converter with dual integrated MOSFETs operates over a 4.5V to 60V input. It delivers up to 2.5A and 0.9V to 90% $V_{IN}$  output voltage. Built-in compensation across the output voltage range eliminates the need for external components. The feedback (FB) regulation accuracy over -40°C to +125°C is  $\pm 1.1\%$ . The device is available in a compact (4mm x 4mm) TQFN-EP lead(Pb)-free package with an exposed pad. Simulation models are available.

The device features a peak-current-mode control architecture with a MODE feature that can be used to operate the device in pulse-width modulation (PWM), pulse-frequency modulation (PFM), or discontinuous-conduction mode (DCM) control schemes. PWM operation provides constant frequency operation at all loads, and is useful in applications sensitive to switching frequency. PFM operation disables negative inductor current and additionally skips pulses at light loads for high efficiency. DCM features constant frequency operation down to lighter loads than PFM mode by not skipping pulses, but only disabling negative inductor current at light loads. DCM operation offers efficiency performance that lies between PWM and PFM modes. The MAX17503S offers a lower minimum on-time that allows for higher switching frequencies and a smaller solution size.

A programmable soft-start feature allows users to reduce input inrush current. The device also incorporates an output enable/input undervoltage lockout pin (EN/UVLO) that allows the user to turn on the part at the desired input-voltage level. An open-drain  $\overline{\text{RESET}}$  pin provides a delayed power-good signal to the system upon achieving successful regulation of the output voltage.

### Applications

- Industrial Power Supplies
- Distributed Supply Regulation
- Base Station Power Supplies
- Wall Transformer Regulation
- High-Voltage Single-Board Systems
- General-Purpose Point-of-Load

### Benefits and Features

- Eliminates External Components and Reduces Total Cost
  - No Schottky-Synchronous Operation for High Efficiency and Reduced Cost
  - Internal Compensation for Stable Operation at Any Output Voltage
  - All-Ceramic Capacitor Solution: Ultra-Compact Layout with as Few as Eight External Components
- Reduces Number of DC-DC Regulators to Stock
  - Wide 4.5V to 60V Input Voltage Range
  - 0.9V to 90% $V_{IN}$  Output Voltage
  - Delivers up to 2.5A Over Temperature
  - 100kHz to 2.2MHz Adjustable Frequency with External Clock Synchronization
  - MAX17503S Allows Higher Frequency of Operation
  - Available in a 20-Pin, 4mm x 4mm TQFN-EP Package
- Reduces Power Dissipation
  - Peak Efficiency of 94%
  - PFM and DCM Modes for High Light-Load Efficiency
  - Shutdown Current = 2.8 $\mu\text{A}$  (typ)
- Operates Reliably
  - Hiccup-Mode Current Limit and Autoretry Startup
  - Built-In Output-Voltage Monitoring (Open-Drain  $\overline{\text{RESET}}$  Pin)
  - Resistor-Programmable EN/UVLO Threshold
  - Adjustable Soft-Start and Prebiased Power-Up
  - Wide -40°C to +125°C Ambient Operating Temperature Range/-40°C to +150°C Junction Temperature Range

**Ordering Information** appears at end of data sheet.

**Absolute Maximum Ratings (Note 1)**

V <sub>IN</sub> to PGND .....	-0.3V to +65V	SGND to PGND.....	-0.3V to +0.3V
EN/UVLO to SGND .....	-0.3V to +65V	LX Total RMS Current .....	±4A
LX to PGND.....	-0.3V to (V <sub>IN</sub> + 0.3V)	Output Short-Circuit Duration .....	Continuous
BST to PGND .....	-0.3V to +70V	Continuous Power Dissipation (T <sub>A</sub> = +70°C) (multilayer board)	
BST to LX.....	-0.3V to +6.5V	TQFN-EP (derate 30.3mW/°C above T <sub>A</sub> = +70°C) ...	2424.2mW
BST to V <sub>CC</sub> .....	-0.3V to +65V	Junction Temperature.....	+150°C
CF, RESET, SS, MODE, SYNC,		Storage Temperature Range.....	-65°C to +160°C
RT to SGND .....	-0.3V to +6.5V	Lead Temperature (soldering, 10s) .....	+300°C
FB to SGND .....	-0.3V to +1.5V	Soldering Temperature (reflow).....	+260°C
V <sub>CC</sub> to SGND .....	-0.3V to +6.5V		

Stresses beyond those listed under "Absolute Maximum Ratings" may cause permanent damage to the device. These are stress ratings only; functional operation of the device at these or any other conditions beyond those indicated in the operational sections of the specifications is not implied. Exposure to absolute maximum rating conditions for extended periods may affect device reliability.

**Note 1:** Junction temperature greater than +125°C degrades operating lifetimes.

**Package Information**

<b>PACKAGE TYPE: 20 TQFN-EP</b>	
Package Code	T2044+4C
Outline Number	<a href="#">21-100172</a>
Land Pattern Number	<a href="#">90-0409</a>
<b>THERMAL RESISTANCE, FOUR-LAYER BOARD</b>	
Junction to Ambient (θ <sub>JA</sub> )	33°C/W
Junction to Case (θ <sub>JC</sub> )	2°C/W

Package thermal resistances were obtained using the method described in JEDEC specification JESD51-7, using a four-layer board. For detailed information on package thermal considerations, refer to [www.maximintegrated.com/thermal-tutorial](http://www.maximintegrated.com/thermal-tutorial).

For the latest package outline information and land patterns (footprints), go to [www.maximintegrated.com/packages](http://www.maximintegrated.com/packages). Note that a "+", "#", or "-" in the package code indicates RoHS status only. Package drawings may show a different suffix character, but the drawing pertains to the package regardless of RoHS status.

**Electrical Characteristics**

(V<sub>IN</sub> = V<sub>EN/UVLO</sub> = 24V, R<sub>RT</sub> = 40.2kΩ (500kHz), C<sub>VCC</sub> = 2.2μF, V<sub>PGND</sub> = V<sub>SGND</sub> = V<sub>MODE</sub> = V<sub>SYNC</sub> = 0V, LX = SS = RESET = open, V<sub>BST</sub> to V<sub>LX</sub> = 5V, V<sub>FB</sub> = 1V, T<sub>A</sub> = -40°C to +125°C, unless otherwise noted. Typical values are at T<sub>A</sub> = +25°C. All voltages are referenced to SGND, unless otherwise noted.) (Note 2)

PARAMETER	SYMBOL	CONDITIONS	MIN	TYP	MAX	UNITS
<b>INPUT SUPPLY (V<sub>IN</sub>)</b>						
Input Voltage Range	V <sub>IN</sub>		4.5		60	V
Input Shutdown Current	I <sub>IN-SH</sub>	V <sub>EN/UVLO</sub> = 0V (shutdown mode)		2.8	4.5	μA
Input Quiescent Current	I <sub>Q-PFM</sub>	V <sub>FB</sub> = 1V, MODE = RT = open		118		
		V <sub>FB</sub> = 1V, MODE = open		162		
	I <sub>Q-DCM</sub>	DCM mode, V <sub>LX</sub> = 0.1V		1.16	1.8	mA
I <sub>Q-PWM</sub>	Normal switching mode, f <sub>SW</sub> = 500kHz, V <sub>FB</sub> = 0.8V		9.5			

**Electrical Characteristics (continued)**

( $V_{IN} = V_{EN/UVLO} = 24V$ ,  $R_{RT} = 40.2k\Omega$  (500kHz),  $C_{VCC} = 2.2\mu F$ ,  $V_{PGND} = V_{SGND} = V_{MODE} = V_{SYNC} = 0V$ ,  $LX = SS = \overline{RESET} =$  open,  $V_{BST}$  to  $V_{LX} = 5V$ ,  $V_{FB} = 1V$ ,  $T_A = -40^\circ C$  to  $+125^\circ C$ , unless otherwise noted. Typical values are at  $T_A = +25^\circ C$ . All voltages are referenced to SGND, unless otherwise noted.) (Note 2)

PARAMETER	SYMBOL	CONDITIONS	MIN	TYP	MAX	UNITS
<b>ENABLE/UVLO (EN/UVLO)</b>						
EN/UVLO Threshold	$V_{ENR}$	$V_{EN/UVLO}$ rising	1.19	1.215	1.26	V
	$V_{ENF}$	$V_{EN/UVLO}$ falling	1.068	1.09	1.131	
EN/UVLO Input Leakage Current	$I_{EN}$	$V_{EN/UVLO} = 0V$ , $T_A = +25^\circ C$	-50	0	+50	nA
<b>LDO</b>						
$V_{CC}$ Output Voltage Range	$V_{CC}$	$6V < V_{IN} < 60V$ , $I_{VCC} = 1mA$	4.75	5	5.25	V
		$1mA \leq I_{VCC} \leq 25mA$				
$V_{CC}$ Current Limit	$I_{VCC-MAX}$	$V_{CC} = 4.3V$ , $V_{IN} = 6V$	26.5	54	100	mA
$V_{CC}$ Dropout	$V_{CC-DO}$	$V_{IN} = 4.5V$ , $I_{VCC} = 20mA$	4.2			V
$V_{CC}$ UVLO	$V_{CC\_UVR}$	$V_{CC}$ rising	4.05	4.2	4.3	V
	$V_{CC\_UVF}$	$V_{CC}$ falling	3.65	3.8	3.9	
<b>POWER MOSFET AND BST DRIVER</b>						
High-Side nMOS On-Resistance	$R_{DS-ONH}$	$I_{LX} = 0.3A$		165	325	m $\Omega$
Low-Side nMOS On-Resistance	$R_{DS-ONL}$	$I_{LX} = 0.3A$		80	150	m $\Omega$
LX Leakage Current	$I_{LX\_LKG}$	$V_{LX} = V_{IN} - 1V$ , $V_{LX} = V_{PGND} + 1V$ , $T_A = +25^\circ C$	-2		+2	$\mu A$
<b>SOFT-START (SS)</b>						
Charging Current	$I_{SS}$	$V_{SS} = 0.5V$	4.7	5	5.3	$\mu A$
<b>FEEDBACK (FB)</b>						
FB Regulation Voltage	$V_{FB\_REG}$	$-40^\circ C \leq T_A \leq +125^\circ C$	0.89	0.9	0.91	V
FB Input Bias Current	$I_{FB}$	$0 < V_{FB} < 1V$ , $T_A = +25^\circ C$	-50		+50	nA
<b>MODE</b>						
MODE Threshold	$V_{M-DCM}$	MODE = $V_{CC}$ (DCM mode)	$V_{CC} - 1.6$			V
	$V_{M-PFM}$	MODE = open (PFM mode)	$V_{CC} / 2$			
	$V_{M-PWM}$	MODE = GND (PWM mode)	1.4			
<b>PFM/HIBERNATE MODE</b>						
FB Threshold for Entering Hibernate Mode	$V_{FB\_HBR}$	$V_{FB}$ rising	100.8	102.3	103.5	%
FB Threshold for Exiting Hibernate Mode	$V_{FB\_HBF}$	$V_{FB}$ falling	100	101.1	102.3	%
<b>CURRENT LIMIT</b>						
Peak Current-Limit Threshold	$I_{PEAK-LIMIT}$		3.2	3.7	4.3	A
Runaway Current-Limit Threshold	$I_{RUNAWAY-LIMIT}$		3.7	4.3	5	A
Valley Current-Limit Threshold	$I_{SINK-LIMIT}$	MODE = open/ $V_{CC}$	-0.16	0	+0.16	A
		MODE = GND		-1.8		
PFM Current-Limit Threshold	$I_{PFM}$	MODE = open	0.6	0.75	0.9	A

**Electrical Characteristics (continued)**

( $V_{IN} = V_{EN/UVLO} = 24V$ ,  $R_{RT} = 40.2k\Omega$  (500kHz),  $C_{VCC} = 2.2\mu F$ ,  $V_{PGND} = V_{SGND} = V_{MODE} = V_{SYNC} = 0V$ ,  $LX = SS = \overline{RESET} =$  open,  $V_{BST}$  to  $V_{LX} = 5V$ ,  $V_{FB} = 1V$ ,  $T_A = -40^\circ C$  to  $+125^\circ C$ , unless otherwise noted. Typical values are at  $T_A = +25^\circ C$ . All voltages are referenced to SGND, unless otherwise noted.) (Note 2)

PARAMETER	SYMBOL	CONDITIONS	MIN	TYP	MAX	UNITS
<b>RT AND SYNC</b>						
Switching Frequency	$f_{SW}$	$R_{RT} = 210k\Omega$	90	100	110	kHz
		$R_{RT} = 102k\Omega$	180	200	220	
		$R_{RT} = 40.2k\Omega$	475	500	525	
		$R_{RT} = 8.06k\Omega$	1950	2200	2450	
		$R_{RT} =$ open	460	500	540	
SYNC Frequency Capture Range		$f_{SW}$ set by $R_{RT}$	1.1 x $f_{SW}$		1.4 x $f_{SW}$	kHz
SYNC Pulse Width			50			ns
SYNC Threshold	$V_{IH}$		2.1			V
	$V_{IL}$				0.8	
FB Undervoltage Trip Level to Cause Hiccup	$V_{FB-HICF}$		0.56	0.58	0.65	V
Hiccup Timeout		(Note 3)		32,768		Cycles
Minimum On-Time	$t_{ON-MIN}$	MAX17503			135	ns
		MAX17503S		55	80	ns
Minimum Off-Time	$t_{OFF-MIN}$		140		160	ns
LX Dead Time				5		ns
<b>RESET</b>						
$\overline{RESET}$ Output Level Low		$I_{RESET} = 10mA$			0.4	V
$\overline{RESET}$ Output Leakage Current		$T_A = T_J = +25^\circ C$ , $V_{RESET} = 5.5V$	-0.1		+0.1	$\mu A$
FB Threshold for $\overline{RESET}$ Assertion	$V_{FB-OKF}$	$V_{FB}$ falling	90.5	92	94.6	% $V_{FB-REG}$
FB Threshold for $\overline{RESET}$ Deassertion	$V_{FB-OKR}$	$V_{FB}$ rising	93.8	95	97.8	% $V_{FB-REG}$
$\overline{RESET}$ Deassertion Delay After FB Reaches 95% Regulation				1024		Cycles
<b>THERMAL SHUTDOWN</b>						
Thermal-Shutdown Threshold		Temperature rising		165		$^\circ C$
Thermal-Shutdown Hysteresis				10		$^\circ C$

**Note 2:** All limits are 100% tested at  $+25^\circ C$ . Limits over temperature are guaranteed by design.

**Note 3:** See the Overcurrent *Protection/Hiccup Mode* Section for more details.

Typical Operating Characteristics

( $V_{IN} = V_{EN}/V_{VLO} = 24V$ ,  $V_{PGND} = V_{SGND} = 0V$ ,  $C_{VIN} = C_{VCC} = 2.2\mu F$ ,  $C_{BST} = 0.1\mu F$ ,  $C_{SS} = 5600pF$ ,  $R_T = MODE = open$ ,  $T_A = -40^\circ C$  to  $+125^\circ C$ , unless otherwise noted. Typical values are at  $T_A = +25^\circ C$ . All voltages are referenced to GND, unless otherwise noted.)

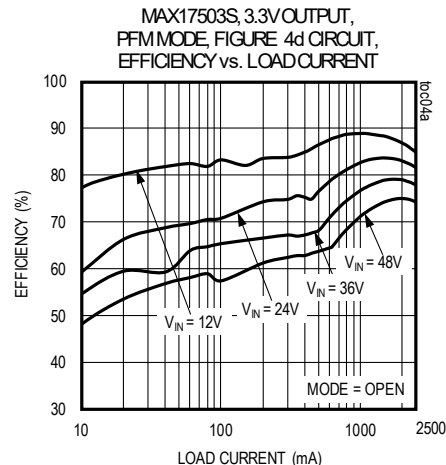
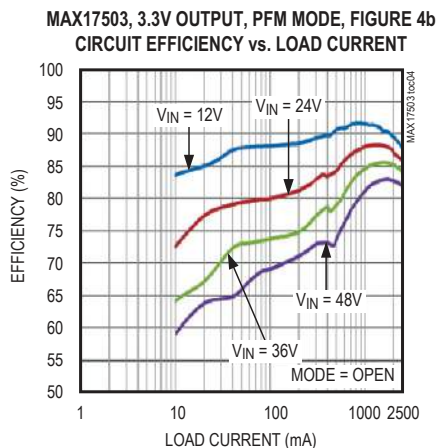
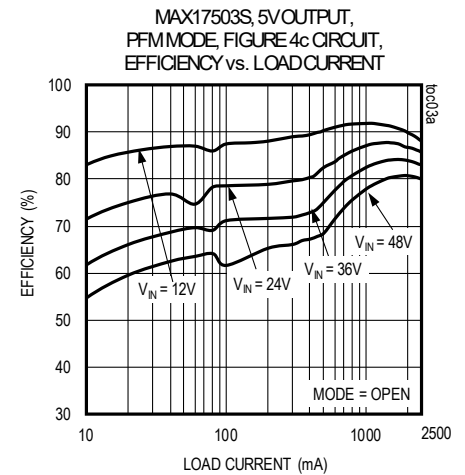
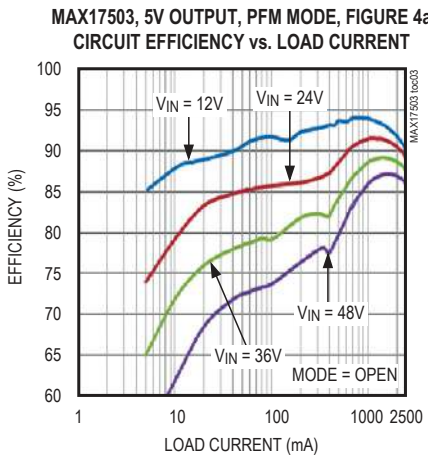
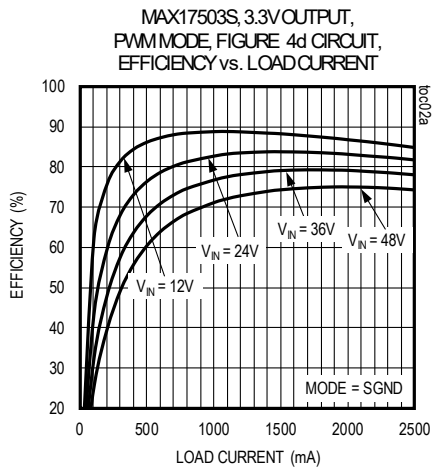
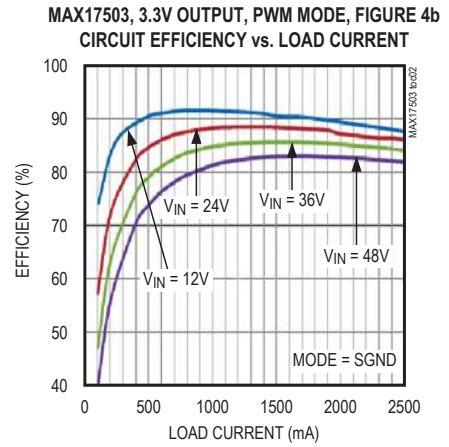
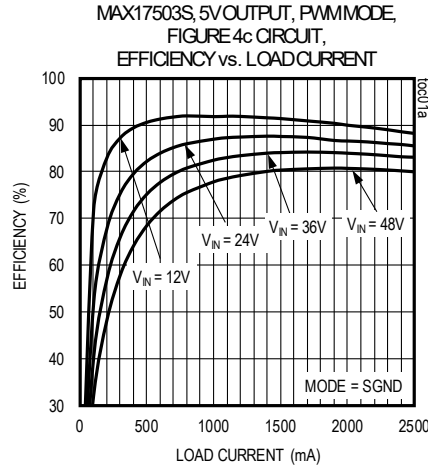
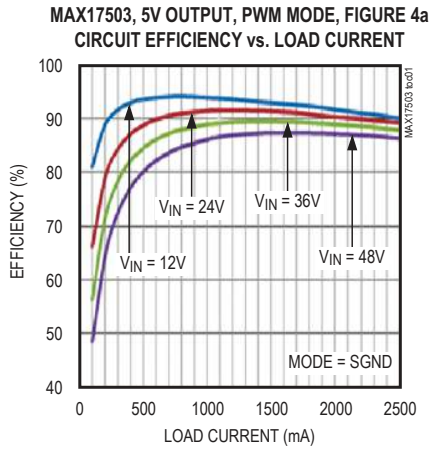

Typical Operating Characteristics (continued)

( $V_{IN} = V_{EN}/UVLO = 24V$ ,  $V_{PGND} = V_{SGND} = 0V$ ,  $C_{VIN} = C_{VCC} = 2.2\mu F$ ,  $C_{BST} = 0.1\mu F$ ,  $C_{SS} = 5600pF$ ,  $R_T = MODE = open$ ,  $T_A = -40^\circ C$  to  $+125^\circ C$ , unless otherwise noted. Typical values are at  $T_A = +25^\circ C$ . All voltages are referenced to GND, unless otherwise noted.)

MAX17503 5V OUTPUT, DCM MODE, FIGURE 4a  
CIRCUIT EFFICIENCY vs. LOAD CURRENT

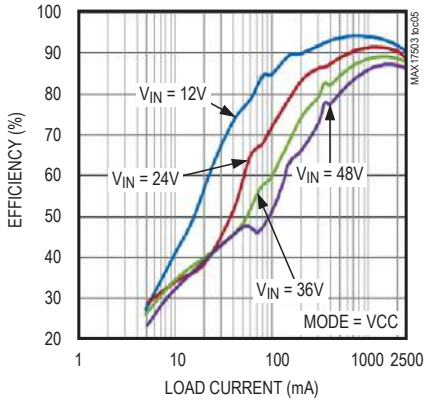

MAX17503S, 5V OUTPUT,  
DCM MODE, FIGURE 4c CIRCUIT,  
EFFICIENCY vs. LOAD CURRENT

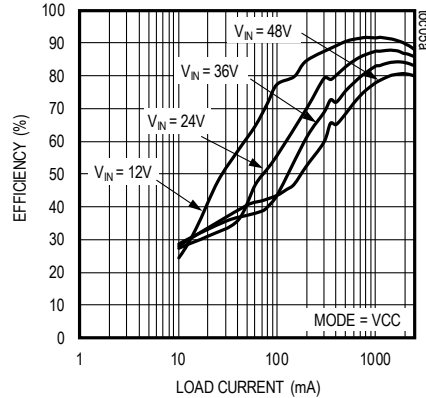

MAX17503, 3.3V OUTPUT, DCM MODE, FIGURE 4b  
CIRCUIT EFFICIENCY vs. LOAD CURRENT

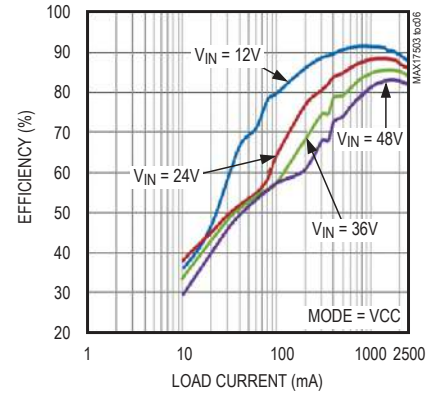

MAX17503S, 3.3V OUTPUT,  
DCM MODE, FIGURE 4d CIRCUIT,  
EFFICIENCY vs. LOAD CURRENT

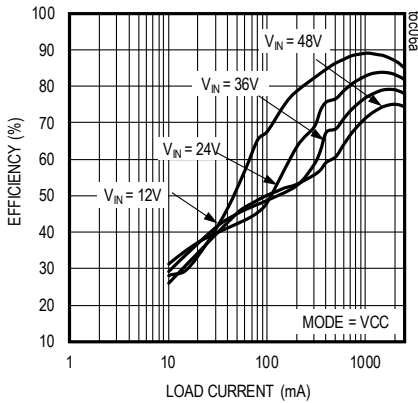

MAX17503, 5V OUTPUT, PWM MODE, FIGURE 4a  
CIRCUIT LOAD AND LINE REGULATION

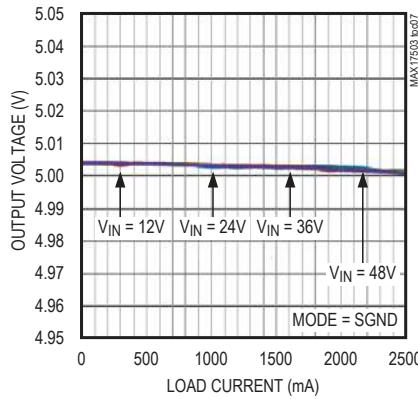

MAX17503S, 5V OUTPUT,  
PWM MODE, FIGURE 4c CIRCUIT,  
LOAD AND LINE REGULATION

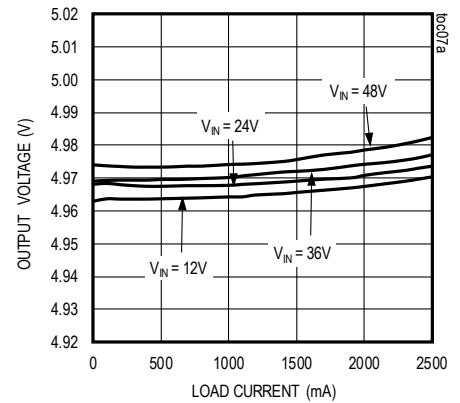

MAX17503, 3.3V OUTPUT, PWM MODE, FIGURE 4b  
CIRCUIT LOAD AND LINE REGULATION

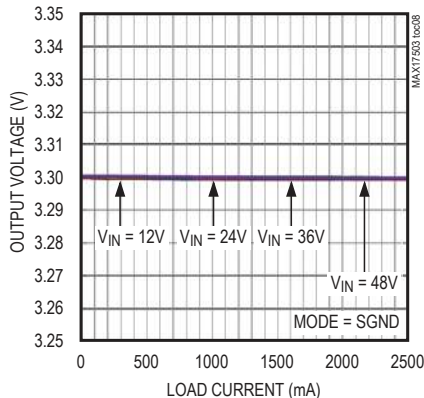

MAX17503S, 3.3V OUTPUT,  
PWM MODE, FIGURE 4d CIRCUIT,  
LOAD AND LINE REGULATION

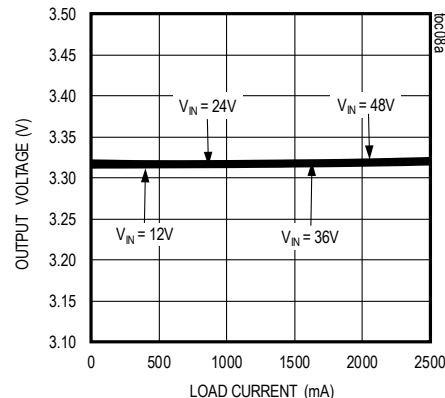

Typical Operating Characteristics (continued)

( $V_{IN} = V_{EN/UVLO} = 24V$ ,  $V_{PGND} = V_{SGND} = 0V$ ,  $C_{VIN} = C_{VCC} = 2.2\mu F$ ,  $C_{BST} = 0.1\mu F$ ,  $C_{SS} = 5600pF$ ,  $RT = MODE = open$ ,  $T_A = -40^\circ C$  to  $+125^\circ C$ , unless otherwise noted. Typical values are at  $T_A = +25^\circ C$ . All voltages are referenced to GND, unless otherwise noted.)

MAX17503, 5V OUTPUT, PFM MODE, FIGURE 4a  
CIRCUIT LOAD AND LINE REGULATION

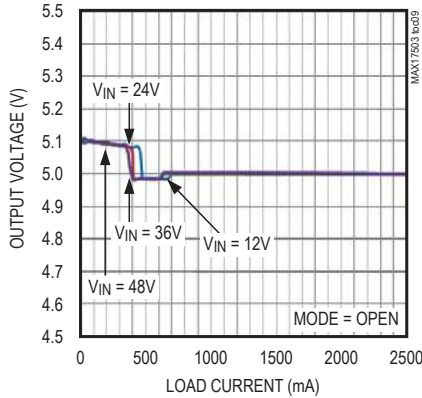

MAX17503S, 5V OUTPUT,  
PFM MODE, FIGURE 4c CIRCUIT,  
LOAD AND LINE REGULATION

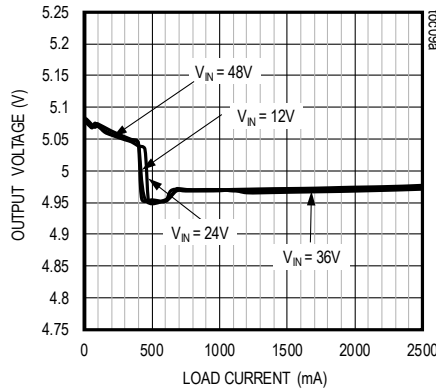

MAX17503, 3.3V OUTPUT, PFM MODE, FIGURE 4b  
CIRCUIT LOAD AND LINE REGULATION

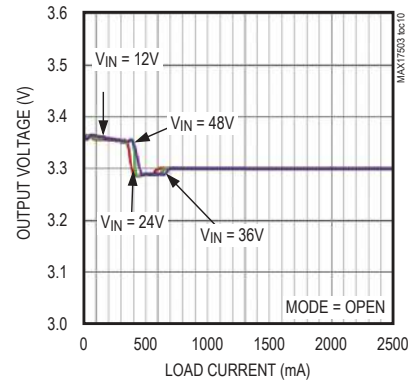

MAX17503S, 3.3V OUTPUT,  
PFM MODE, FIGURE 4d CIRCUIT,  
LOAD AND LINE REGULATION

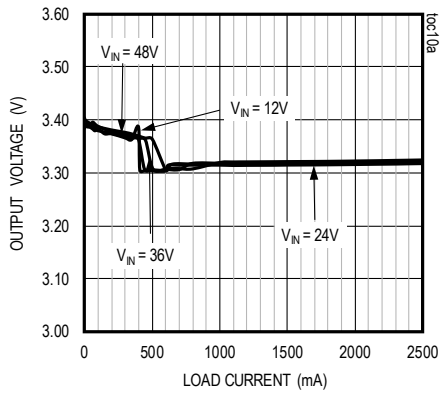

SWITCHING FREQUENCY vs.  
RT RESISTANCE

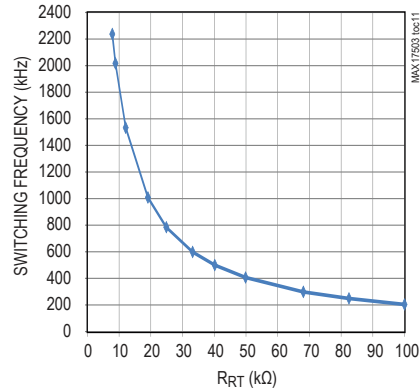

MAX17503, SOFT-START/SHUTDOWN FROM EN/UVLO  
5V OUTPUT, 2.5A LOAD CURRENT,  
FIGURE 4a CIRCUIT

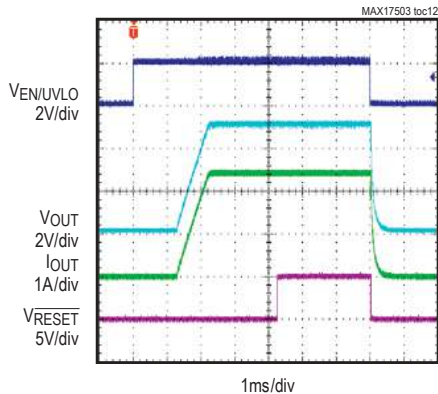

MAX17503S, SOFT-START/  
SHUTDOWN FROM EN/UVLO, 5V OUTPUT,  
2.5A LOAD CURRENT, FIGURE 4c CIRCUIT

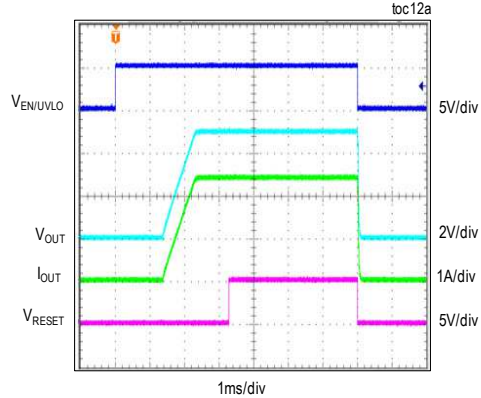

Typical Operating Characteristics (continued)

( $V_{IN} = V_{EN/UVLO} = 24V$ ,  $V_{PGND} = V_{SGND} = 0V$ ,  $C_{VIN} = C_{VCC} = 2.2\mu F$ ,  $C_{BST} = 0.1\mu F$ ,  $C_{SS} = 5600pF$ ,  $RT = MODE = open$ ,  $T_A = -40^{\circ}C$  to  $+125^{\circ}C$ , unless otherwise noted. Typical values are at  $T_A = +25^{\circ}C$ . All voltages are referenced to GND, unless otherwise noted.)

MAX17503 SOFT-START/SHUTDOWN FROM EN/UVLO  
3.3V OUTPUT, 2.5A LOAD CURRENT,  
FIGURE 4b CIRCUIT

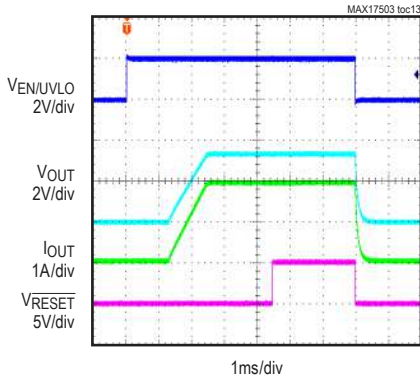

MAX17503S, SOFT-START/  
SHUTDOWN FROM EN/UVLO, 3.3V OUTPUT,  
2.5A LOAD CURRENT, FIGURE 4d CIRCUIT)

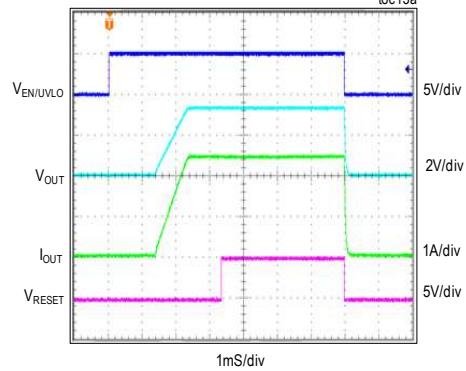

MAX17503 SOFT-START/SHUTDOWN FROM EN/UVLO  
5V OUTPUT, PFM MODE, 5mA LOAD CURRENT,  
FIGURE 4a CIRCUIT

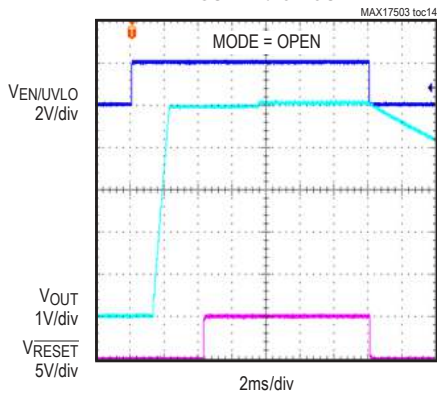

MAX17503S, SOFT-START/SHUTDOWN  
FROM EN/UVLO, 5V OUTPUT, PFM MODE 5mA  
LOAD CURRENT, FIGURE 4c CIRCUIT)

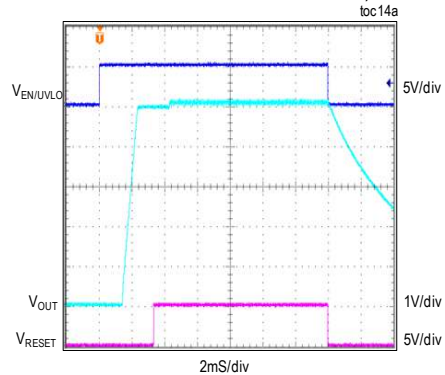

MAX17503 SOFT-START/SHUTDOWN FROM EN/UVLO,  
3.3V OUTPUT, PFM MODE, 5mA LOAD  
CURRENT, FIGURE 4b CIRCUIT

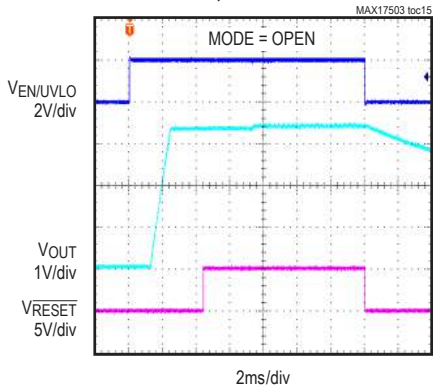

MAX17503S, SOFT-START/SHUTDOWN  
FROM EN/UVLO, 3.3V OUTPUT, PFM MODE 5mA  
LOAD CURRENT, FIGURE 4d CIRCUIT)

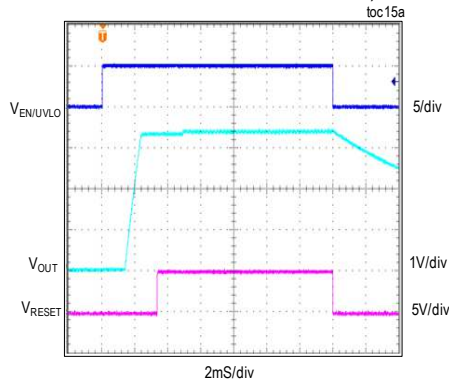



Typical Operating Characteristics (continued)

( $V_{IN} = V_{EN/UVLO} = 24V$ ,  $V_{PGND} = V_{SGND} = 0V$ ,  $C_{VIN} = C_{VCC} = 2.2\mu F$ ,  $C_{BST} = 0.1\mu F$ ,  $C_{SS} = 5600pF$ ,  $R_T = MODE = open$ ,  $T_A = -40^\circ C$  to  $+125^\circ C$ , unless otherwise noted. Typical values are at  $T_A = +25^\circ C$ . All voltages are referenced to GND, unless otherwise noted.)

MAX17503 5V OUTPUT, PWM MODE  
SOFT-START WITH 2.5V PREBIAS,  
FIGURE 4a CIRCUIT

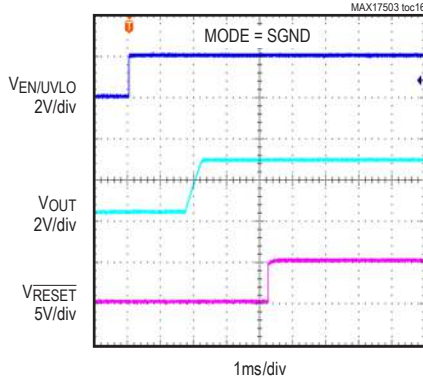

MAX17503S, SOFT-START WITH 2.5V PREBIAS,  
5V OUTPUT, PWM MODE, FIGURE 4c CIRCUIT

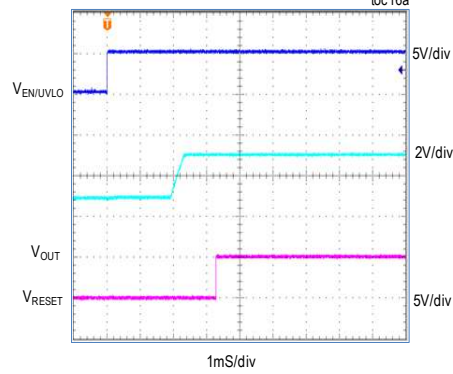

MAX17503 3.3V OUTPUT, PFM MODE  
SOFT-START WITH 2.5V PREBIAS,  
FIGURE 4b CIRCUIT

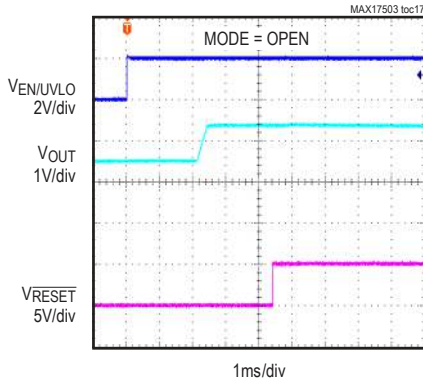

MAX17503S, SOFT-START WITH 2.5V PREBIAS,  
3.3V OUTPUT, PWM MODE, FIGURE 4d CIRCUIT

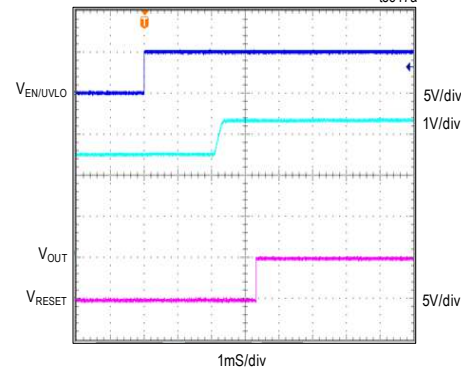

MAX17503 5V OUTPUT, 2.5A LOAD CURRENT  
STEADY-STATE SWITCHING WAVEFORMS,  
FIGURE 4a CIRCUIT

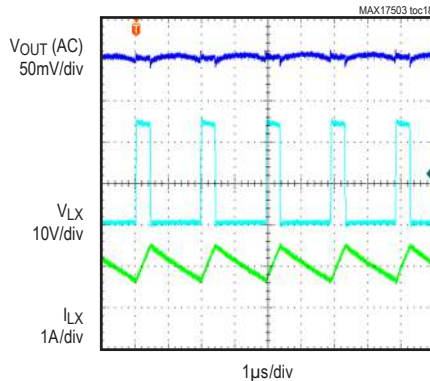

MAX17503S, STEADY-STATE  
SWITCHING WAVEFORMS, 5V OUTPUT,  
2.5A LOAD CURRENT, FIGURE 4c CIRCUIT

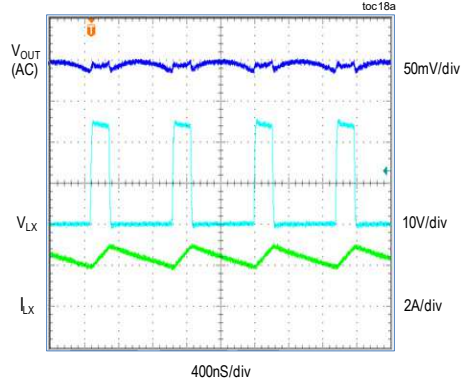

Typical Operating Characteristics (continued)

(T<sub>A</sub> = +25°C, unless otherwise noted.)

MAX17503 5V OUTPUT, PWM MODE, NO LOAD  
STEADY-STATE SWITCHING WAVEFORMS,  
FIGURE 4a CIRCUIT

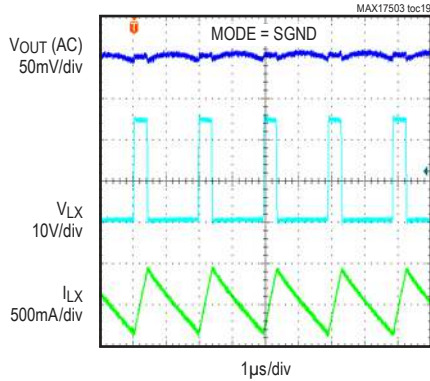

MAX17503S, STEADY-STATE  
SWITCHING WAVEFORMS, 5V OUTPUT,  
NO LOAD CURRENT, FIGURE 4c CIRCUIT

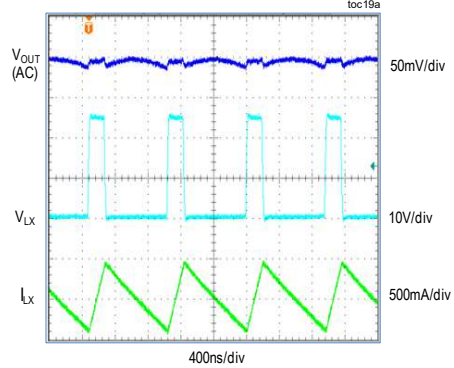

MAX17503 5V OUTPUT, PFM MODE, 25mA LOAD  
STEADY-STATE SWITCHING WAVEFORMS,  
FIGURE 4a CIRCUIT

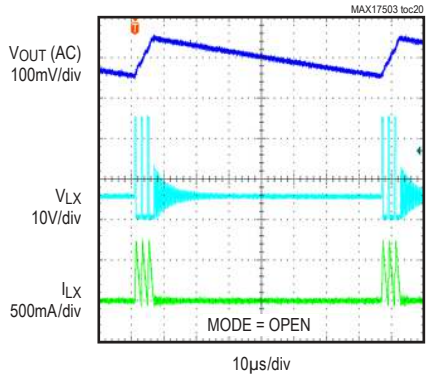

MAX17503S, STEADY-STATE  
SWITCHING WAVEFORMS, 5V OUTPUT, PFM MODE,  
25mA LOAD CURRENT, FIGURE 4c CIRCUIT

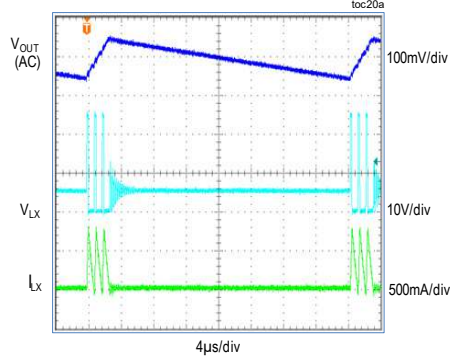

MAX17503 5V OUTPUT, DCM MODE, 25mA LOAD  
STEADY-STATE SWITCHING WAVEFORMS,  
FIGURE 4a CIRCUIT

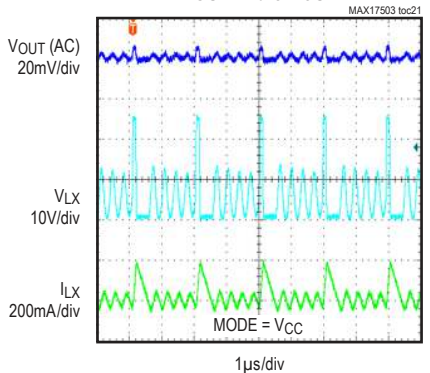

MAX17503S, STEADY-STATE  
SWITCHING WAVEFORMS, 5V OUTPUT, DCM MODE,  
25mA LOAD CURRENT, FIGURE 4c CIRCUIT

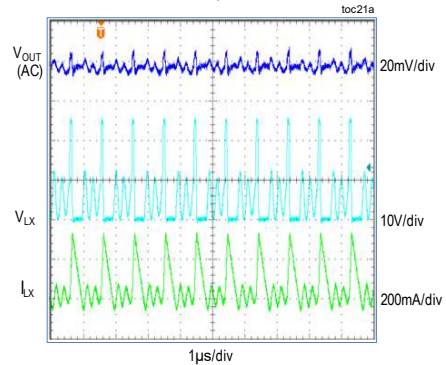

Typical Operating Characteristics (continued)

( $V_{IN} = V_{EN/UVLO} = 24V$ ,  $V_{PGND} = V_{SGND} = 0V$ ,  $C_{VIN} = C_{VCC} = 2.2\mu F$ ,  $C_{BST} = 0.1\mu F$ ,  $C_{SS} = 5600pF$ ,  $R_T = MODE = open$ ,  $T_A = -40^\circ C$  to  $+125^\circ C$ , unless otherwise noted. Typical values are at  $T_A = +25^\circ C$ . All voltages are referenced to GND, unless otherwise noted.)

MAX17503 5V OUTPUT, PWM MODE  
(LOAD CURRENT STEPPED FROM 1A TO 2A),  
FIGURE 4a CIRCUIT

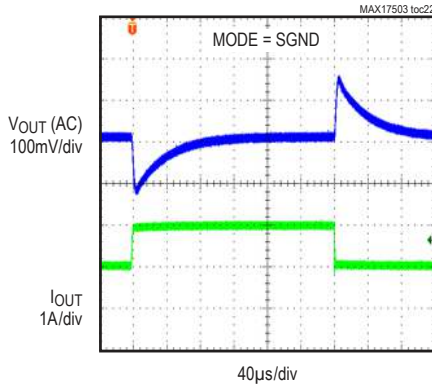

MAX17503S, 5V OUTPUT,  
PWM MODE, FIGURE 4c CIRCUIT  
(LOAD CURRENT STEPPED FROM 1A TO 2A)

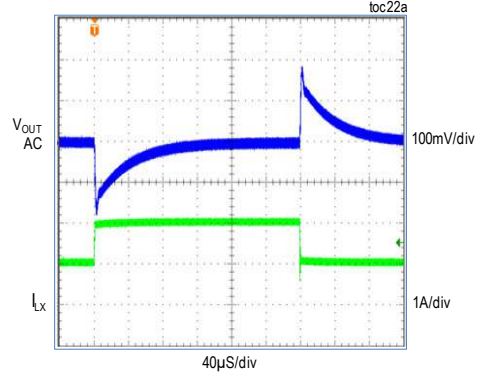

MAX17503 3.3V OUTPUT, PWM MODE  
(LOAD CURRENT STEPPED FROM 1A TO 2A),  
FIGURE 4b CIRCUIT

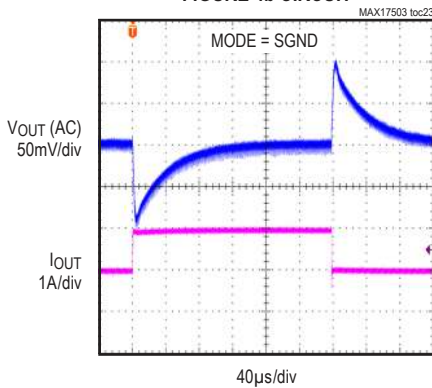

MAX17503S, 3.3V OUTPUT,  
PWM MODE, FIGURE 4d CIRCUIT  
(LOAD CURRENT STEPPED FROM 1A TO 2A)

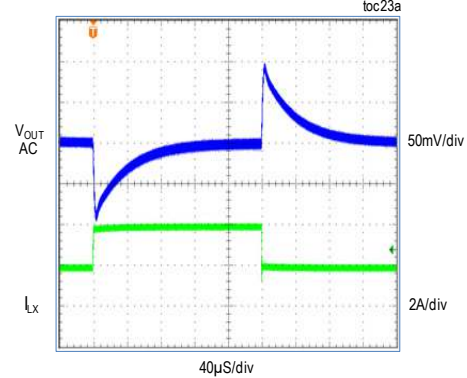

MAX17503 5V OUTPUT, PWM MODE (LOAD CURRENT  
STEPPED FROM NO-LOAD TO 1A),  
FIGURE 4a CIRCUIT

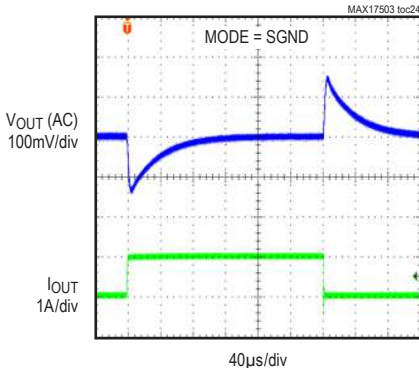

MAX17503S, 5V OUTPUT,  
PWM MODE, FIGURE 4c CIRCUIT  
(LOAD CURRENT STEPPED FROM NO LOAD TO 1A)

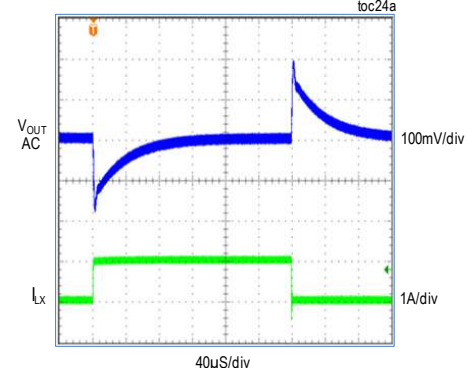

Typical Operating Characteristics (continued)

(T<sub>A</sub> = +25°C, unless otherwise noted.)

MAX17503 3.3V OUTPUT, PWM MODE (LOAD CURRENT STEPPED FROM NO-LOAD TO 1A), FIGURE 4b CIRCUIT

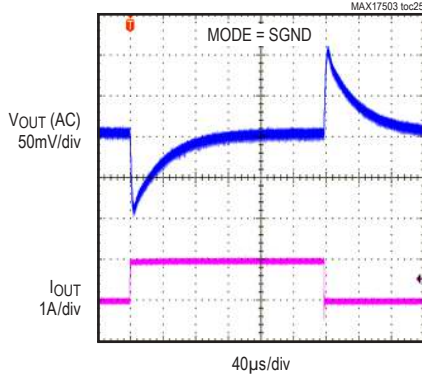

MAX17503S, 3.3V OUTPUT, PWM MODE, FIGURE 4d CIRCUIT (LOAD CURRENT STEPPED FROM NO LOAD TO 1A)

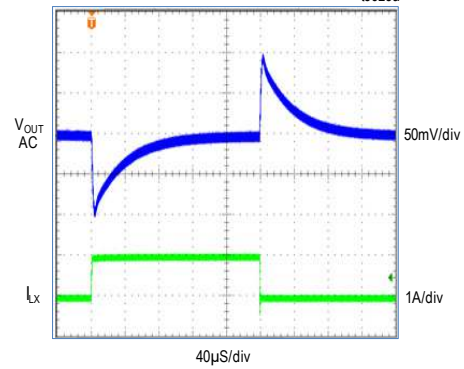

MAX17503 5V OUTPUT, PFM MODE (LOAD CURRENT STEPPED FROM 5mA TO 1A), FIGURE 4a CIRCUIT

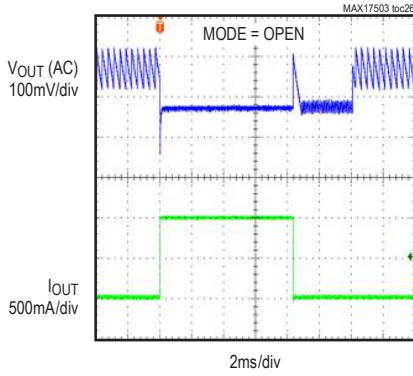

MAX17503S, 5V OUTPUT, PFM MODE, FIGURE 4c CIRCUIT (LOAD CURRENT STEPPED FROM 5mA TO 1A)

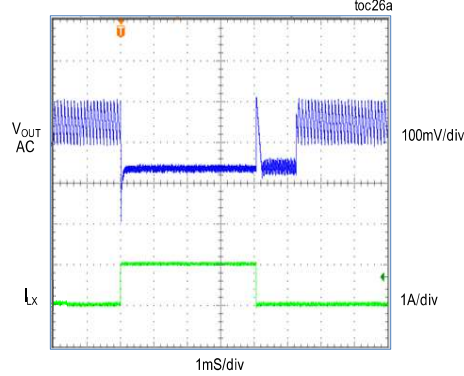

MAX17503 3.3V OUTPUT, PFM MODE (LOAD CURRENT STEPPED FROM 5mA TO 1A), FIGURE 4b CIRCUIT

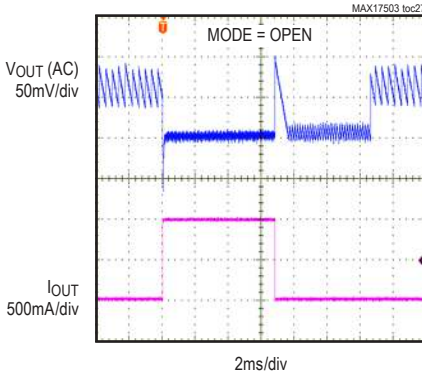

MAX17503S, 3.3V OUTPUT, PFM MODE, FIGURE 4d CIRCUIT (LOAD CURRENT STEPPED FROM 5mA TO 1A)

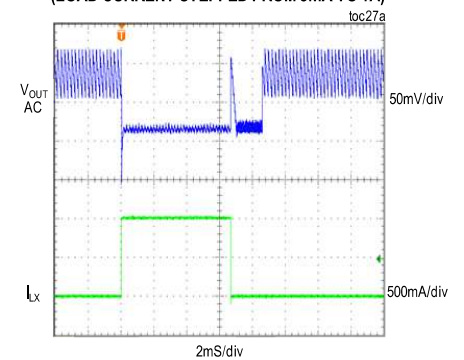

Typical Operating Characteristics (continued)

( $V_{IN} = V_{EN/UVLO} = 24V$ ,  $V_{PGND} = V_{SGND} = 0V$ ,  $C_{VIN} = C_{VCC} = 2.2\mu F$ ,  $C_{BST} = 0.1\mu F$ ,  $C_{SS} = 5600pF$ ,  $RT = MODE = open$ ,  $T_A = -40^{\circ}C$  to  $+125^{\circ}C$ , unless otherwise noted. Typical values are at  $T_A = +25^{\circ}C$ . All voltages are referenced to GND, unless otherwise noted.)

MAX17503 5V OUTPUT, DCM MODE (LOAD CURRENT STEPPED FROM 50mA TO 1A), FIGURE 4a CIRCUIT

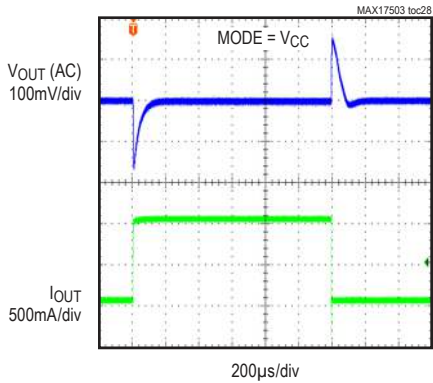

MAX17503S, 5V OUTPUT, DCM MODE (LOAD CURRENT STEPPED FROM 50mA TO 1A) FIGURE 4c CIRCUIT

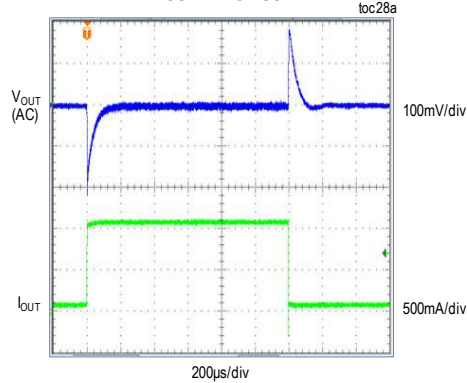

MAX17503 3.3V OUTPUT, DCM MODE (LOAD CURR STEPPED FROM 50mA TO 1A), FIGURE 4b CIRCUIT

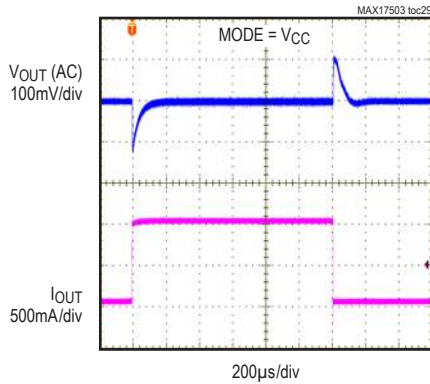

MAX17503S, 3.3V OUTPUT, DCM MODE (LOAD CURRENT STEPPED FROM 50mA TO 1A) FIGURE 4d CIRCUIT

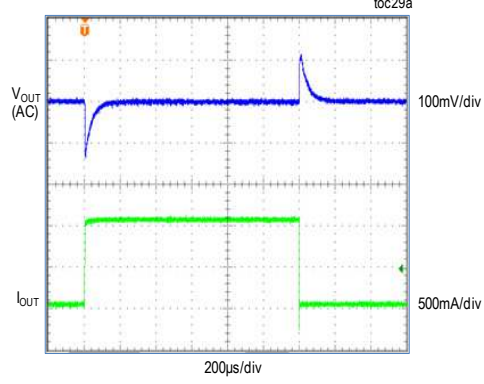

MAX17503 5V OUTPUT, OVERLOAD PROTECTION FIGURE 4a CIRCUIT

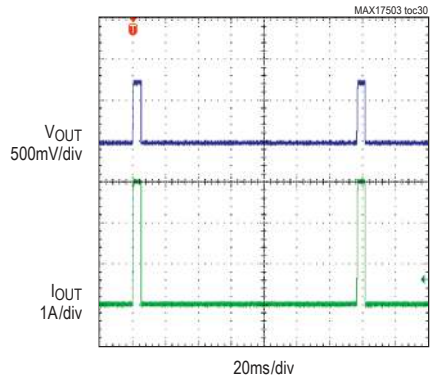

MAX17503S, OVERLOAD PROTECTION 5V OUTPUT, FIGURE 4c CIRCUIT

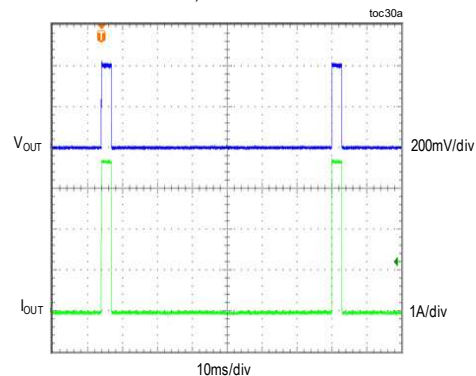

Typical Operating Characteristics (continued)

(T<sub>A</sub> = +25°C, unless otherwise noted.)

MAX17503 5V OUTPUT, APPLICATION OF  
EXTERNAL CLOCK AT 700kHz,  
FIGURE 4a CIRCUIT

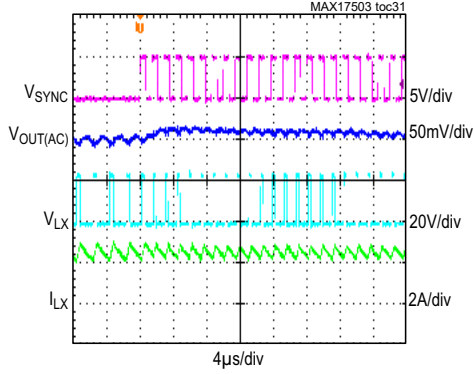

MAX17503S 5V OUTPUT, APPLICATION OF  
EXTERNAL CLOCK AT 1.2MHz,  
FIGURE 4c CIRCUIT

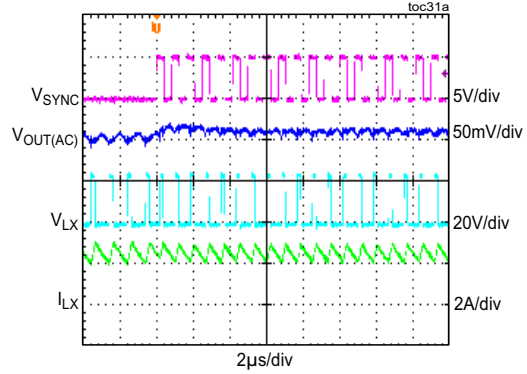

MAX17503 5V OUTPUT, 2.5A LOAD CURRENT  
BODE PLOT, FIGURE 4a CIRCUIT

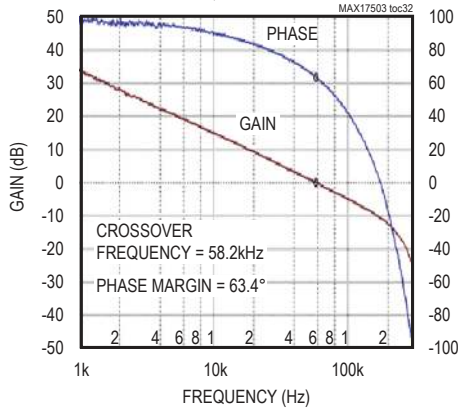

MAX17503S, 5V OUTPUT, 2.5A LOAD CURRENT,  
BODEPLOT, FIGURE 4c CIRCUIT

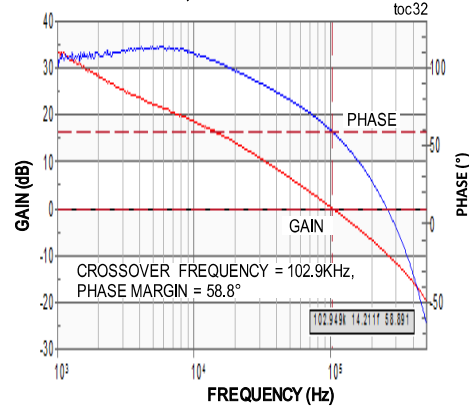

MAX17503 5V OUTPUT, 2.5A LOAD CURRENT  
BODE PLOT, FIGURE 4b CIRCUIT

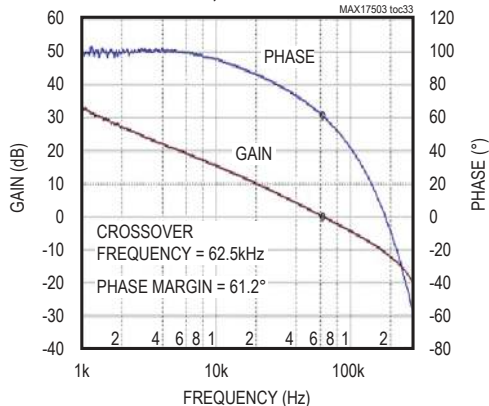

MAX17503S, 3.3V OUTPUT, 2.5A LOAD CURRENT,  
BODE PLOT, FIGURE 4c CIRCUIT

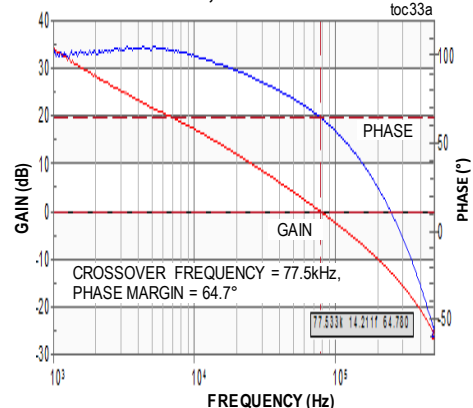

## Pin Configuration

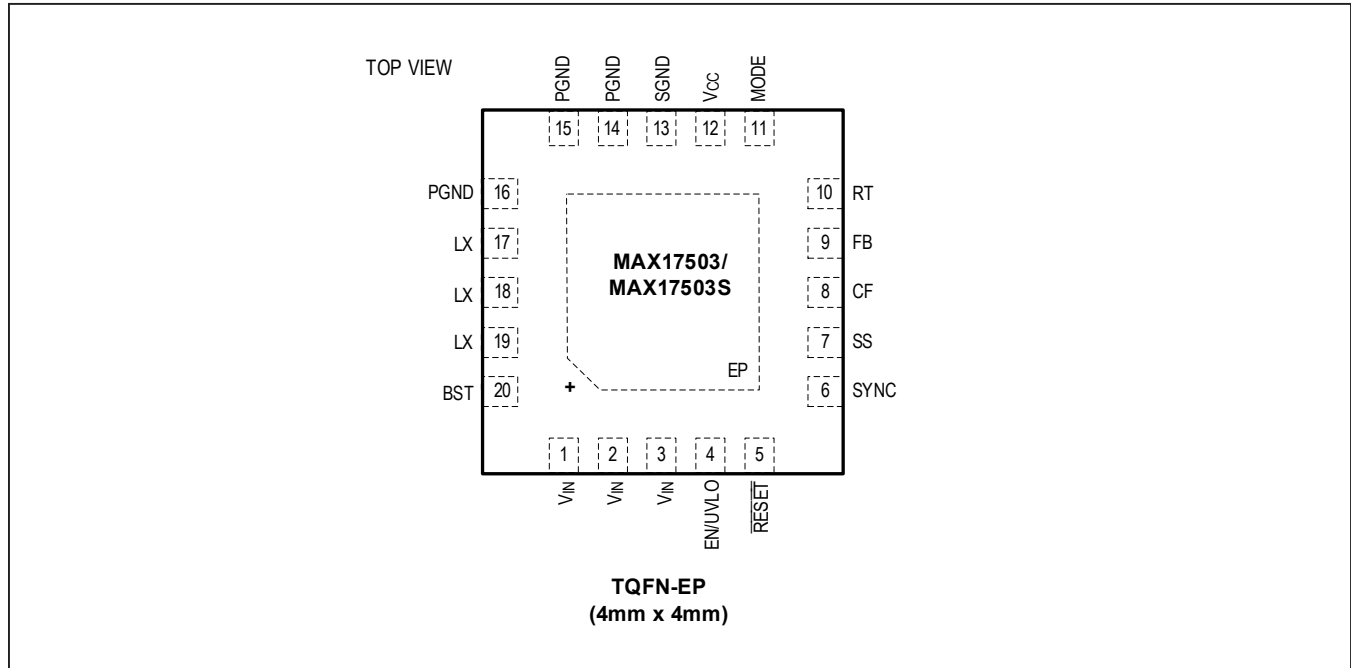

## Pin Description

PIN	NAME	FUNCTION
1–3	$V_{IN}$	Power-Supply Input. 4.5V to 60V input supply range. Connect the $V_{IN}$ pins together. Decouple to PGND with a 2.2 $\mu$ F capacitor; place the capacitor close to the $V_{IN}$ and PGND pins. Refer to the MAX17503/MAX17503S EV kit data sheets for a layout example.
4	EN/UVLO	Enable/Undervoltage Lockout. Drive EN/UVLO high to enable the output voltage. Connect to the center of the resistor-divider between $V_{IN}$ and SGND to set the input voltage at which the device turns on. Pull up to $V_{IN}$ for always-on operation.
5	$\overline{\text{RESET}}$	Open-Drain $\overline{\text{RESET}}$ Output. The $\overline{\text{RESET}}$ output is driven low if FB drops below 92% of its set value. $\overline{\text{RESET}}$ goes high 1024 clock cycles after FB rises above 95% of its set value.
6	SYNC	The device can be synchronized to an external clock using this pin. See the <a href="#">External Clock Synchronization (SYNC)</a> section for more details.
7	SS	Soft-Start Input. Connect a capacitor from SS to SGND to set the soft-start time.
8	CF	At switching frequencies lower than 500kHz, connect a capacitor from CF to FB. Leave CF open if switching frequency is equal or more than 500kHz. See the <a href="#">Loop Compensation</a> section for more details.
9	FB	Feedback Input. Connect FB to the center tap of an external resistor-divider from the output to GND to set the output voltage. See the <a href="#">Adjusting Output Voltage</a> section for more details.
10	RT	Connect a resistor from RT to SGND to set the regulator's switching frequency. Leave RT open for the default 500kHz frequency. See the <a href="#">Setting the Switching Frequency (RT)</a> section for more details.
11	MODE	MODE pin configures the device to operate either in PWM, PFM, or DCM modes of operation. Leave MODE unconnected for PFM operation (pulse skipping at light loads). Connect MODE to SGND for constant-frequency PWM operation at all loads. Connect MODE to $V_{CC}$ for DCM operation. See the <a href="#">Mode Selection (MODE)</a> section for more details.

Pin Description (continued)

PIN	NAME	FUNCTION
12	V <sub>CC</sub>	5V LDO Output. Bypass V <sub>CC</sub> with 2.2μF ceramic capacitance to SGND.
13	SGND	Analog Ground
14–16	PGND	Power Ground. Connect the PGND pins externally to the power ground plane. Connect the SGND and PGND pins together at the ground return path of the V <sub>CC</sub> bypass capacitor. Refer to the MAX17503/MAX17503S EV kit data sheets for a layout example.
17–19	LX	Switching Node. Connect LX pins to the switching side of the inductor. Refer to the MAX17503/MAX17503S EV kit data sheets for a layout example.
20	BST	Boost Flying Capacitor. Connect a 0.1μF ceramic capacitor between BST and LX.
—	EP	Exposed pad. Connect to the SGND pin. Connect to a large copper plane below the IC to improve heat dissipation capability. Add thermal vias below the exposed pad. Refer to the MAX17503/MAX17503S EV kit data sheets for a layout example.

Block Diagram

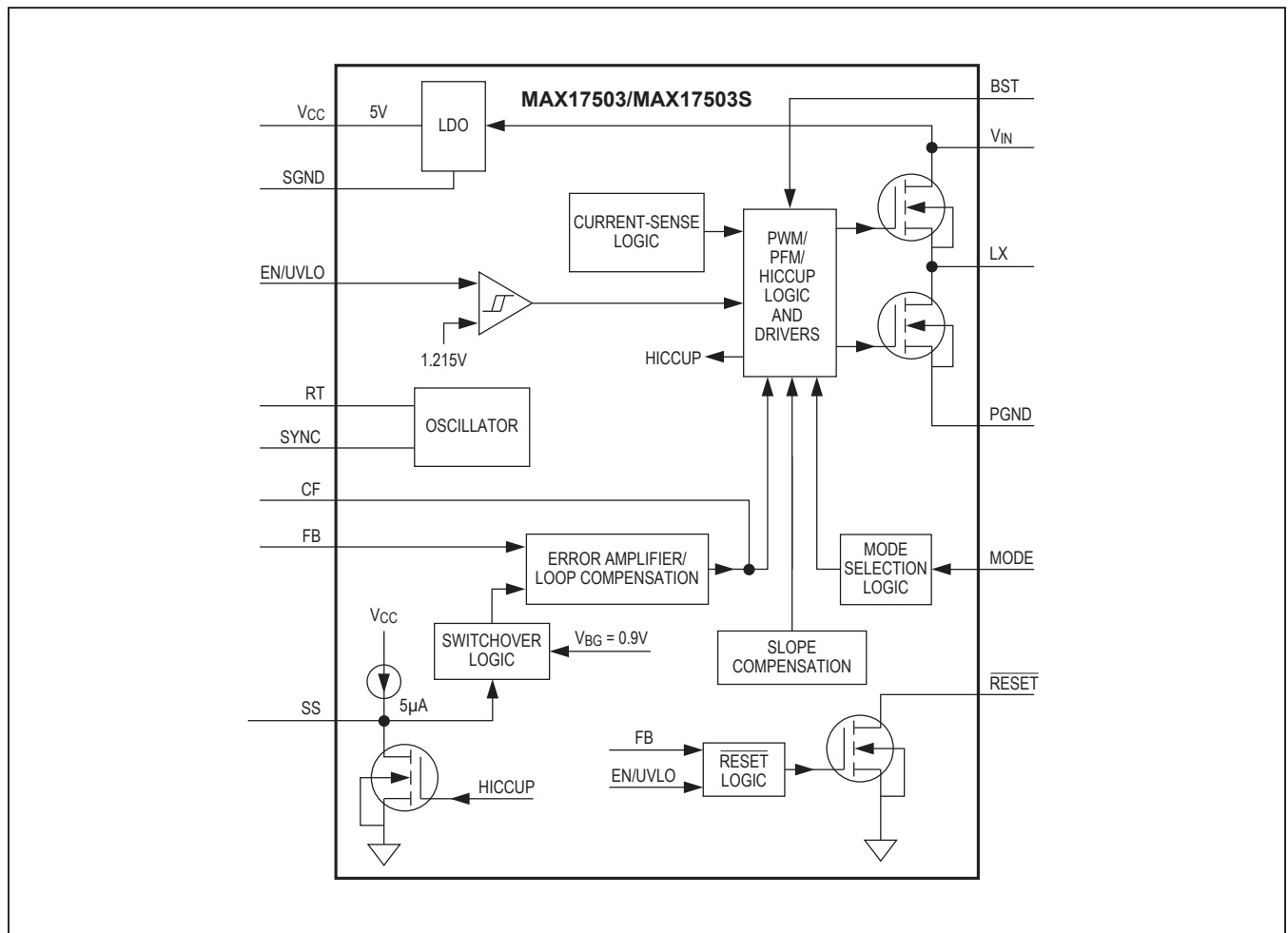



## Detailed Description

The MAX17503/MAX17503S high-efficiency, high-voltage, synchronously rectified step-down converter with dual integrated MOSFETs operates over a 4.5V to 60V input. It delivers up to 2.5A and 0.9V to 90% $V_{IN}$  output voltage. Built-in compensation across the output voltage range eliminates the need for external components. The feedback (FB) regulation accuracy over  $-40^{\circ}\text{C}$  to  $+125^{\circ}\text{C}$  is  $\pm 1.1\%$ .

The device features a peak-current-mode control architecture. An internal transconductance error amplifier produces an integrated error voltage at an internal node, which sets the duty cycle using a PWM comparator, a high-side current-sense amplifier, and a slope-compensation generator. At each rising edge of the clock, the high-side MOSFET turns on and remains on until either the appropriate or maximum duty cycle is reached, or the peak current limit is detected. During the high-side MOSFET's on-time, the inductor current ramps up. During the second half of the switching cycle, the high-side MOSFET turns off and the low-side MOSFET turns on. The inductor releases the stored energy as its current ramps down and provides current to the output.

The device features a MODE pin that can be used to operate the device in PWM, PFM, or DCM control schemes. The device integrates adjustable-input undervoltage lockout, adjustable soft-start, open  $\overline{\text{RESET}}$ , and external clock synchronization features. The MAX17503S offers a lower Minimum On-Time that allows for higher switching frequencies and a smaller solution size.

### Mode Selection (MODE)

The logic state of the MODE pin is latched when  $V_{CC}$  and EN/UVLO voltages exceed the respective UVLO rising thresholds and all internal voltages are ready to allow LX switching. If the MODE pin is open at power-up, the device operates in PFM mode at light loads. If the MODE pin is grounded at power-up, the device operates in constant-frequency PWM mode at all loads. If the MODE pin is connected to  $V_{CC}$  at power-up, the device operates in constant-frequency DCM mode at light loads. State changes on the MODE pin are ignored during normal operation.

### PWM Mode Operation

In PWM mode, the inductor current is allowed to go negative. PWM operation provides constant frequency operation at all loads, and is useful in applications sensitive to switching frequency. However, the PWM mode of operation gives lower efficiency at light loads compared to PFM and DCM modes of operation.

### PFM Mode Operation

PFM mode of operation disables negative inductor current and additionally skips pulses at light loads for high efficiency. In PFM mode, the inductor current is forced to a fixed peak of 750mA every clock cycle until the output rises to 102.3% of the nominal voltage. Once the output reaches 102.3% of the nominal voltage, both the high-side and low-side FETs are turned off and the device enters hibernate operation until the load discharges the output to 101.1% of the nominal voltage. Most of the internal blocks are turned off in hibernate operation to save quiescent current. After the output falls below 101.1% of the nominal voltage, the device comes out of hibernate operation, turns on all internal blocks, and again commences the process of delivering pulses of energy to the output until it reaches 102.3% of the nominal output voltage.

The advantage of the PFM mode is higher efficiency at light loads because of lower quiescent current drawn from supply. The disadvantage is that the output-voltage ripple is higher compared to PWM or DCM modes of operation and switching frequency is not constant at light loads.

### DCM Mode Operation

DCM mode of operation features constant frequency operation down to lighter loads than PFM mode, by not skipping pulses but only disabling negative inductor current at light loads. DCM operation offers efficiency performance that lies between PWM and PFM modes.

### Linear Regulator ( $V_{CC}$ )

An internal linear regulator ( $V_{CC}$ ) provides a 5V nominal supply to power the internal blocks and the low-side MOSFET driver. The output of the linear regulator ( $V_{CC}$ ) should be bypassed with a 2.2 $\mu\text{F}$  ceramic capacitor to SGND. The device employs an undervoltage lockout circuit that disables the internal linear regulator when  $V_{CC}$  falls below 3.8V (typ).

**Setting the Switching Frequency (RT)**

The switching frequency of the device can be programmed from 100kHz to 2.2MHz by using a resistor connected from the RT pin to SGND. The switching frequency ( $f_{SW}$ ) is related to the resistor connected at the RT pin ( $R_{RT}$ ) by the following equation:

$$R_{RT} \cong \frac{21 \times 10^3}{f_{SW}} - 1.7$$

where  $R_{RT}$  is in  $k\Omega$  and  $f_{SW}$  is in kHz. Leaving the RT pin open causes the device to operate at the default switching frequency of 500kHz. See [Table 1](#) for RT resistor values for a few common switching frequencies. To operate the MAX17503/MAX17503S at switching frequencies lower than 200kHz, an R-C network has to be connected in parallel to the resistor connected from RT to SGND, as shown in [Figure 1](#). The values of the components R8 and C13 are 90.9k $\Omega$  and 220pF, respectively.

**Operating Input Voltage Range**

The minimum and maximum operating input voltages for a given output voltage should be calculated as follows:

$$V_{IN(MIN)} = \frac{V_{OUT} + (I_{OUT(MAX)} \times (R_{DCR} + 0.15))}{1 - (f_{SW(MAX)} \times t_{OFF(MAX)})} + (I_{OUT(MAX)} \times 0.175)$$

$$V_{IN(MAX)} = \frac{V_{OUT}}{f_{SW(MAX)} \times t_{ON(MIN)}}$$

where  $V_{OUT}$  is the steady-state output voltage,  $I_{OUT(MAX)}$  is the maximum load current,  $R_{DCR}$  is the DC resistance of the inductor,  $f_{SW(MAX)}$  is the maximum switching frequency,  $t_{OFF-MAX}$  is the worst-case minimum switch off-time (160ns), and  $t_{ON-MIN}$  is the worst-case minimum switch on-time (135ns for the MAX17503, 80ns for the MAX17503S).

**Table 1. Switching Frequency vs. RT Resistor**

SWITCHING FREQUENCY (kHz)	RT RESISTOR (k $\Omega$ )
500	Open
100	210
200	102
400	49.9
1000	19.1
2200	8.06

**External Clock Synchronization (SYNC)**

The internal oscillator of the device can be synchronized to an external clock signal on the SYNC pin. The external clock frequency must be between  $1.1 \times f_{SW}$  and  $1.4 \times f_{SW}$ , where  $f_{SW}$  is the frequency programmed by the RT resistor. The minimum external clock pulse-width high should be greater than 50ns. See the *RT AND SYNC* section in the [Electrical Characteristics](#) table for details.

**Overcurrent Protection/Hiccup Mode**

The device is provided with a robust overcurrent protection scheme that protects the device under overload and output short-circuit conditions. A cycle-by-cycle peak current limit turns off the high-side MOSFET whenever the high-side switch current exceeds an internal limit of 3.7A (typ). A runaway current limit on the high-side switch current at 4.3A (typ) protects the device under high input voltage, short-circuit conditions when there is insufficient output voltage available to restore the inductor current that was built up during the on-period of the step-down converter. One occurrence of the runaway current limit triggers a hiccup mode. In addition, if due to a fault condition, feedback voltage drops to 0.58V (typ) any time after soft-start is complete, and hiccup mode is triggered. In hiccup mode, the converter is protected by suspending switching for a hiccup timeout period of 32,768 clock cycles. Once the hiccup timeout period expires, soft-start is attempted again. Note that when soft-start is attempted under overload condition, if feedback voltage does not exceed 0.58V, the device switches at half the programmed switching frequency. Hiccup mode of operation ensures low power dissipation under output short-circuit conditions.

**RESET Output**

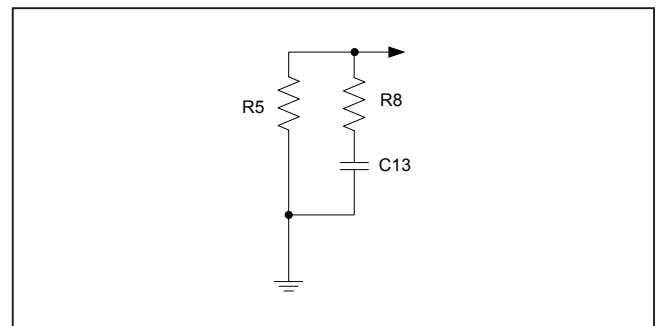

Figure 1. Setting the Switching Frequency

The device includes a  $\overline{\text{RESET}}$  comparator to monitor the output voltage. The open-drain  $\overline{\text{RESET}}$  output requires an external pullup resistor.  $\overline{\text{RESET}}$  goes high (high impedance) 1024 switching cycles after the regulator output increases above 95% of the designed nominal regulated voltage.  $\overline{\text{RESET}}$  goes low when the regulator output voltage drops to below 92% of the nominal regulated voltage.  $\overline{\text{RESET}}$  also goes low during thermal shutdown.

### Prebiased Output

When the device starts into a prebiased output, both the high-side and the low-side switches are turned off so that the converter does not sink current from the output. High-side and low-side switches do not start switching until the PWM comparator commands the first PWM pulse, at which point switching commences. The output voltage is then smoothly ramped up to the target value in alignment with the internal reference.

### Thermal-Shutdown Protection

Thermal-shutdown protection limits total power dissipation in the device. When the junction temperature of the device exceeds +165°C, an on-chip thermal sensor shuts down the device, allowing the device to cool. The thermal sensor turns the device on again after the junction temperature cools by 10°C. Soft-start resets during thermal shutdown. Carefully evaluate the total power dissipation (see the [Power Dissipation](#) section) to avoid unwanted triggering of the thermal shutdown in normal operation.

## Applications Information

### Input Capacitor Selection

The input filter capacitor reduces peak currents drawn from the power source and reduces noise and voltage ripple on the input caused by the circuit's switching. The input capacitor RMS current requirement ( $I_{\text{RMS}}$ ) is defined by the following equation:

$$I_{\text{RMS}} = I_{\text{OUT(MAX)}} \times \frac{\sqrt{V_{\text{OUT}} \times (V_{\text{IN}} - V_{\text{OUT}})}}{V_{\text{IN}}}$$

where,  $I_{\text{OUT(MAX)}}$  is the maximum load current.  $I_{\text{RMS}}$  has a maximum value when the input voltage equals twice the output voltage ( $V_{\text{IN}} = 2 \times V_{\text{OUT}}$ ), so  $I_{\text{RMS(MAX)}} = I_{\text{OUT(MAX)}/2$ .

Choose an input capacitor that exhibits less than +10°C temperature rise at the RMS input current for optimal long-term reliability. Use low-ESR ceramic capacitors with high-ripple-current capability at the input. X7R capacitors are recommended in industrial applications for their

temperature stability. Calculate the input capacitance using the following equation:

$$C_{\text{IN}} = \frac{I_{\text{OUT(MAX)}} \times D \times (1-D)}{\eta \times f_{\text{SW}} \times \Delta V_{\text{IN}}}$$

where  $D = V_{\text{OUT}}/V_{\text{IN}}$  is the duty ratio of the controller,  $f_{\text{SW}}$  is the switching frequency,  $\Delta V_{\text{IN}}$  is the allowable input voltage ripple, and  $\eta$  is the efficiency.

In applications where the source is located distant from the device input, an electrolytic capacitor should be added in parallel to the ceramic capacitor to provide necessary damping for potential oscillations caused by the inductance of the longer input power path and input ceramic capacitor.

### Inductor Selection

Three key inductor parameters must be specified for operation with the device: inductance value (L), inductor saturation current ( $I_{\text{SAT}}$ ), and DC resistance ( $R_{\text{DCR}}$ ). The switching frequency and output voltage determine the inductor value as follows:

$$L = \frac{V_{\text{OUT}}}{f_{\text{SW}}}$$

where  $V_{\text{OUT}}$ , and  $f_{\text{SW}}$  are nominal values.

Select a low-loss inductor closest to the calculated value with acceptable dimensions and having the lowest possible DC resistance. The saturation current rating ( $I_{\text{SAT}}$ ) of the inductor must be high enough to ensure that saturation can occur only above the peak current-limit value of 3.7A.

### Output Capacitor Selection

X7R ceramic output capacitors are preferred due to their stability over temperature in industrial applications. The output capacitors are usually sized to support a step load of 50% of the maximum output current in the application, so the output voltage deviation is contained to 3% of the output voltage change. The minimum required output capacitance can be calculated as follows:

$$C_{\text{OUT}} = \frac{1}{2} \times \frac{I_{\text{STEP}} \times t_{\text{RESPONSE}}}{\Delta V_{\text{OUT}}}$$

$$t_{\text{RESPONSE}} \cong \left( \frac{0.33}{f_{\text{C}}} + \frac{1}{f_{\text{sw}}} \right)$$

where  $I_{\text{STEP}}$  is the load current step,  $t_{\text{RESPONSE}}$  is the response time of the controller,  $\Delta V_{\text{OUT}}$  is the allowable output-voltage deviation,  $f_{\text{C}}$  is the target closed-loop crossover frequency, and  $f_{\text{SW}}$  is the switching frequency.

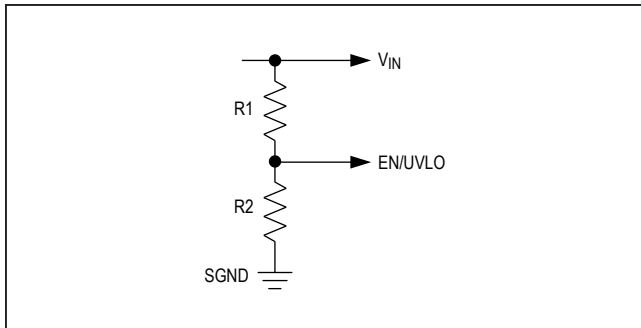

Figure 2. Setting the Input Undervoltage Lockout

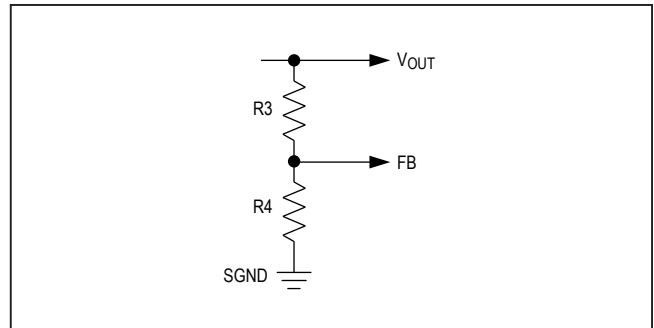

Figure 3. Setting the Output Voltage

**Table 2. C6 Capacitor Value at Various Switching Frequencies**

SWITCHING FREQUENCY RANGE (kHz)	C6 (pF)
200 to 300	2.2
300 to 400	1.2
400 to 500	0.75

For the MAX17503, select  $f_C$  to be 1/9th of  $f_{SW}$  if the switching frequency is less than or equal to 500kHz. If the switching frequency is more than 500kHz, select  $f_C$  to be 55kHz. For the MAX17503S, select  $f_C$  to be 1/10th of  $f_{SW}$  if the switching frequency is less than or equal to 1MHz. If the switching frequency is more than 1MHz, select  $f_C$  to be 100kHz.

Derating of ceramic capacitors with DC-voltage must be considered while selecting the output capacitor. Derating curves are available from all major ceramic capacitor vendors.

**Soft-Start Capacitor Selection**

The device implements adjustable soft-start operation to reduce inrush current. A capacitor connected from the SS pin to SGND programs the soft-start time. The selected output capacitance ( $C_{SEL}$ ) and the output voltage ( $V_{OUT}$ ) determine the minimum required soft-start capacitor as follows:

$$C_{SS} \geq 28 \times 10^{-6} \times C_{SEL} \times V_{OUT}$$

The soft-start time ( $t_{SS}$ ) is related to the capacitor connected at SS ( $C_{SS}$ ) by the following equation:

$$t_{SS} = \frac{C_{SS}}{5.55 \times 10^{-6}}$$

For example, to program a 1ms soft-start time, a 5.6nF capacitor should be connected from the SS pin to SGND.

**Setting the Input Undervoltage-Lockout Level**

The device offers an adjustable input undervoltage-lockout level. Set the voltage at which the device turns on with a resistive voltage-divider connected from  $V_{IN}$  to SGND. Connect the center node of the divider to EN/UVLO.

Choose R1 to be 3.3M $\Omega$  and then calculate R2 as follows:

$$R2 = \frac{R1 \times 1.215}{(V_{INU} - 1.215)}$$

where  $V_{INU}$  is the voltage at which the device is required to turn on. Ensure that  $V_{INU}$  is higher than 0.8 x  $V_{OUT}$ . If the EN/UVLO pin is driven from an external signal source, a series resistance of minimum 1k $\Omega$  is recommended to be placed between the signal source output and the EN/UVLO pin, to reduce voltage ringing on the line.

**Loop Compensation**

The device is internally loop compensated. However, if the switching frequency is less than 500kHz, connect a 0402 capacitor C6 between the CF pin and the FB pin. Use [Table 2](#) to select the value of C6.

If the switching frequency is less than 200kHz, connect an additional R-C network in parallel to the top resistor of the feedback divider (R3). See [Figure 5](#) to calculate the values of the components R7, C12, and C6.

### Adjusting Output Voltage

Set the output voltage with a resistive voltage-divider connected from the positive terminal of the output capacitor ( $V_{OUT}$ ) to SGND (see [Figure 3](#)). Connect the center node of the divider to the FB pin. Use the following procedure to choose the resistive voltage-divider values:

Calculate resistor R3 from the output to the FB pin as follows:

$$R3 = \frac{216 \times 10^3}{f_C \times C_{OUT}}$$

where R3 is in k $\Omega$ , crossover frequency  $f_C$  is in kHz, and the output capacitor  $C_{OUT}$  is in  $\mu$ F. For the MAX17503, choose  $f_C$  to be 1/9th of the switching frequency,  $f_{SW}$ , if the switching frequency is less than or equal to 500kHz. If the switching frequency is more than 500kHz, select  $f_C$  to be 55kHz. For the MAX17503S, select  $f_C$  to be 1/10th of  $f_{SW}$  if the switching frequency is less than or equal to 1MHz. If the switching frequency is more than 1MHz, select  $f_C$  to be 100kHz.

Calculate resistor R4 from the FB pin to SGND as follows:

$$R4 = \frac{R3 \times 0.9}{(V_{OUT} - 0.9)}$$

### Power Dissipation

At a particular operating condition, the power losses that lead to temperature rise of the part are estimated as follows:

$$P_{LOSS} = (P_{OUT} \times (\frac{1}{\eta} - 1)) - (I_{OUT}^2 \times R_{DCR})$$

$$P_{OUT} = V_{OUT} \times I_{OUT}$$

where  $P_{OUT}$  is the total output power,  $\eta$  is the efficiency of the converter, and  $R_{DCR}$  is the DC resistances of the inductor. (See the [Typical Operating Characteristics](#) for more information on efficiency at typical operating conditions.)

For a multilayer board, the thermal performance metrics for the package are given below:

$$\theta_{JA} = 33^\circ\text{C/W}$$

$$\theta_{JC} = 2^\circ\text{C/W}$$

The junction temperature of the device can be estimated at any given maximum ambient temperature ( $T_{A\_MAX}$ ) from the equation below:

$$T_{J\_MAX} = T_{A\_MAX} + (\theta_{JA} \times P_{LOSS})$$

If the application has a thermal management system that ensures that the exposed pad of the device is maintained at a given temperature ( $T_{EP\_MAX}$ ) by using proper heat sinks, then the junction temperature of the device can be estimated at any given maximum ambient temperature from the equation below:

$$T_{J\_MAX} = T_{EP\_MAX} + (\theta_{JC} \times P_{LOSS})$$

Junction temperature greater than +125°C degrades operating lifetimes.

### PCB Layout Guidelines

All connections carrying pulsed currents must be very short and as wide as possible. The inductance of these connections must be kept to an absolute minimum due to the high di/dt of the currents. Since inductance of a current carrying loop is proportional to the area enclosed by the loop, if the loop area is made very small, inductance is reduced. Additionally, small-current loop areas reduce radiated EMI.

A ceramic input filter capacitor should be placed close to the  $V_{IN}$  pins of the IC. This eliminates as much trace inductance effects as possible and gives the IC a cleaner voltage supply. A bypass capacitor for the  $V_{CC}$  pin also should be placed close to the pin to reduce effects of trace impedance.

When routing the circuitry around the IC, the analog small-signal ground and the power ground for switching currents must be kept separate. They should be connected together at a point where switching activity is at a minimum, typically the return terminal of the  $V_{CC}$  bypass capacitor. This helps keep the analog ground quiet. The ground plane should be kept continuous/unbroken as far as possible. No trace carrying high switching current should be placed directly over any ground plane discontinuity.

PCB layout also affects the thermal performance of the design. A number of thermal vias that connect to a large ground plane should be provided under the exposed pad of the part, for efficient heat dissipation.

For a sample layout that ensures first pass success, refer to the MAX17503 evaluation kit layout available at [www.maximintegrated.com](http://www.maximintegrated.com).

Recommended Component Placement for MAX17503/MAX17503S

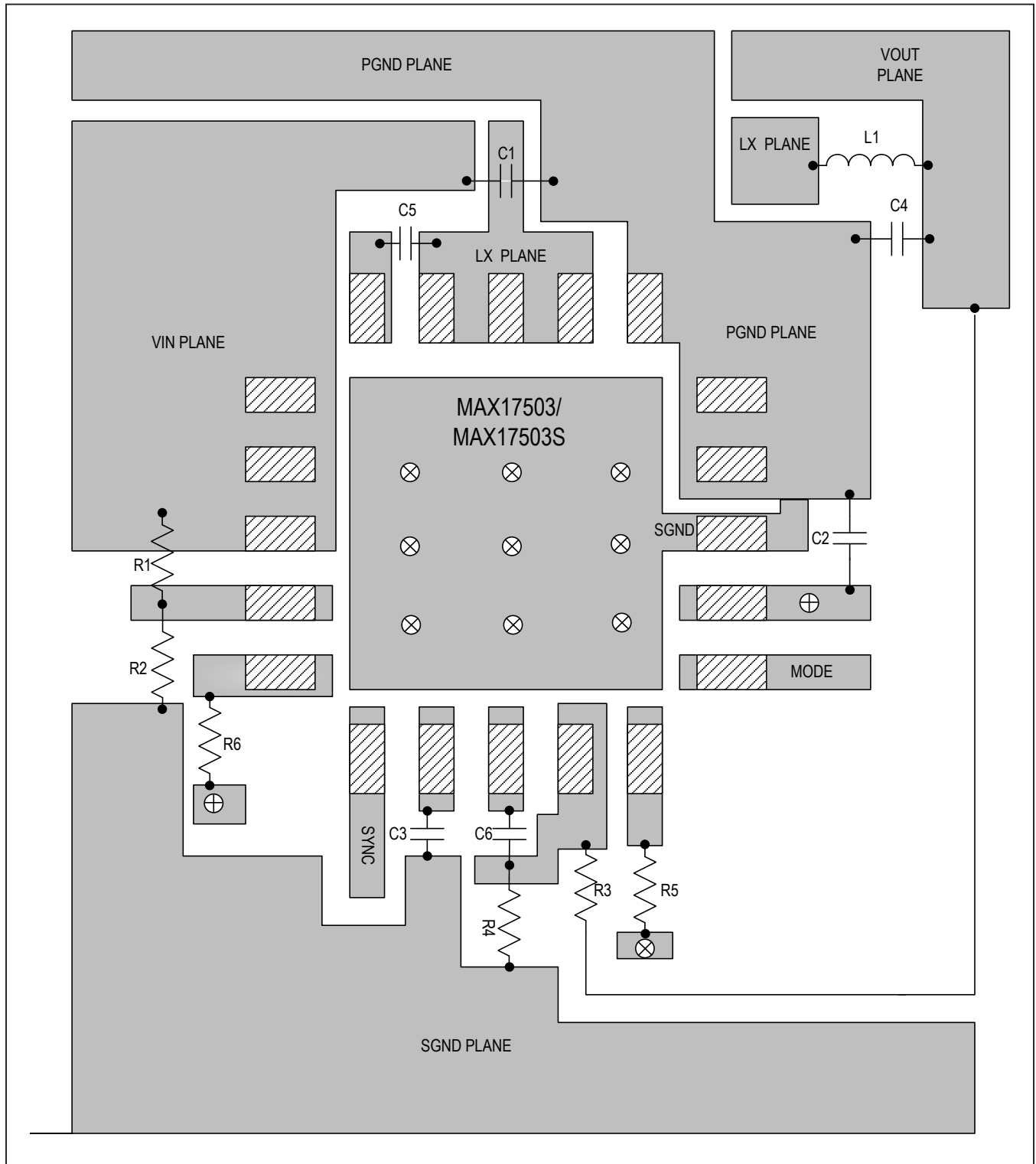

Recommended Component Placement for MAX17503/MAX17503S (continued)

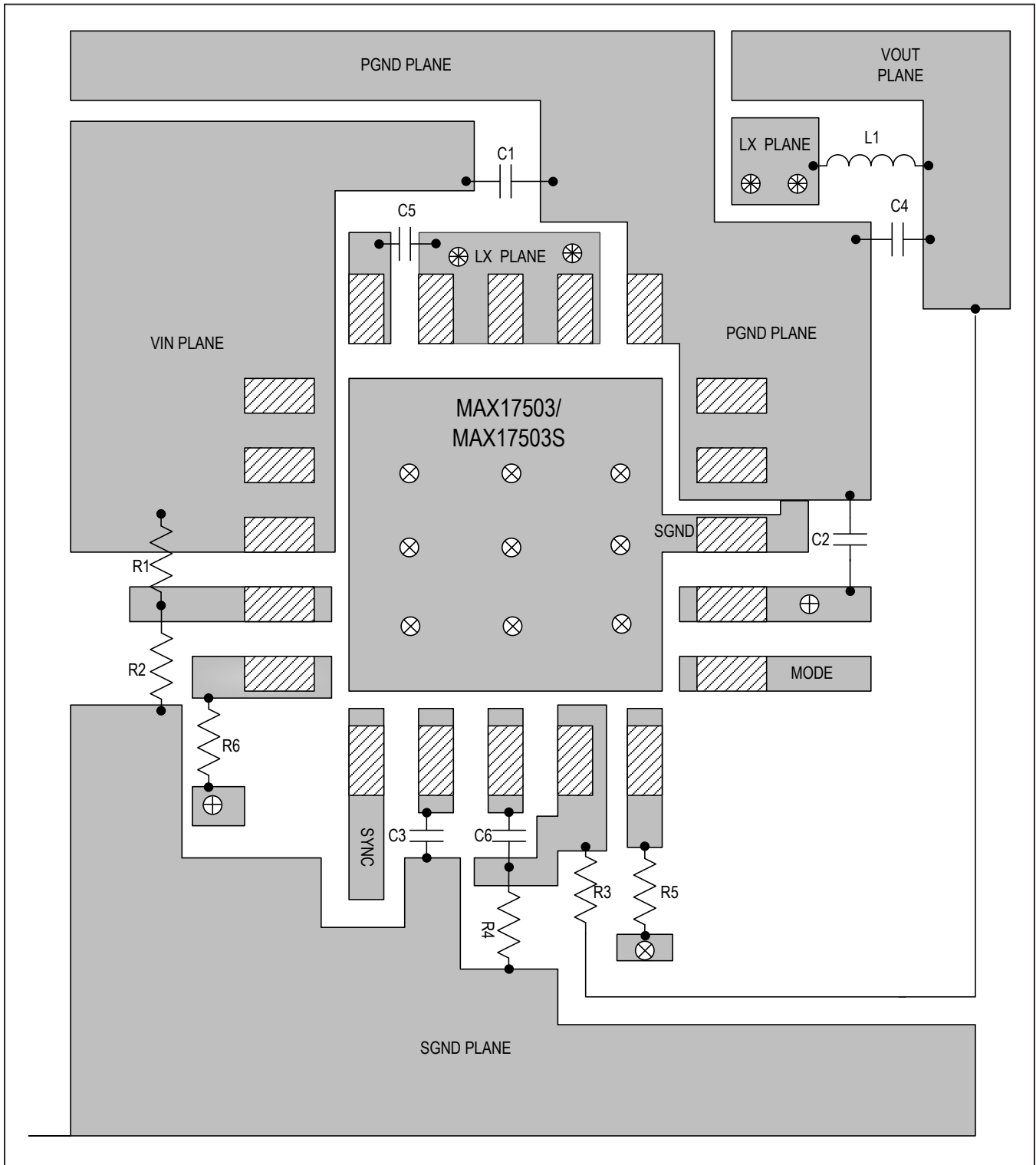

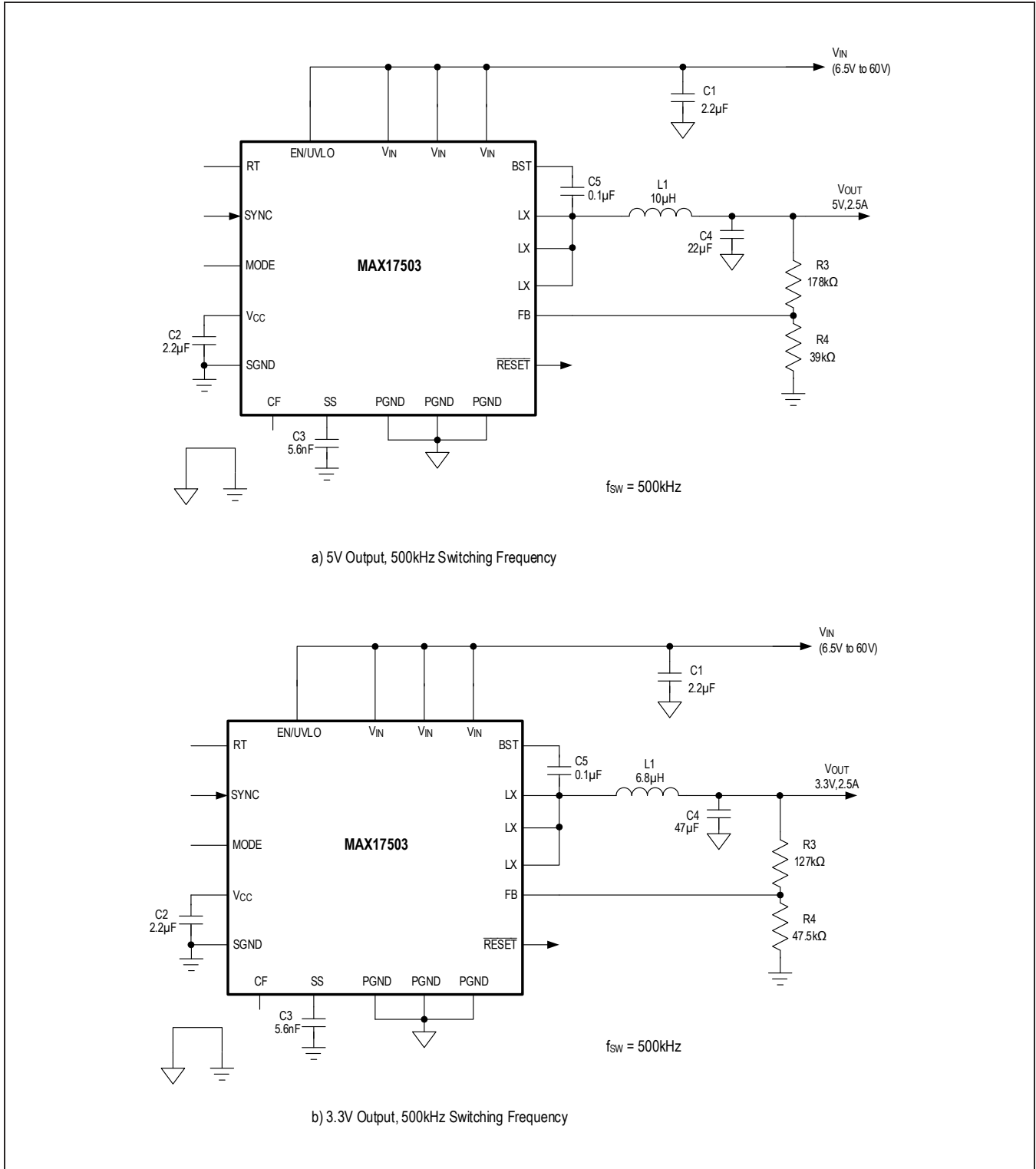

Figure 4. MAX17503/MAX17503S Typical Application Circuits



MAX17503

4.5V-60V, 2.5A, High-Efficiency,  
Synchronous Step-Down DC-DC Converter  
With Internal Compensation

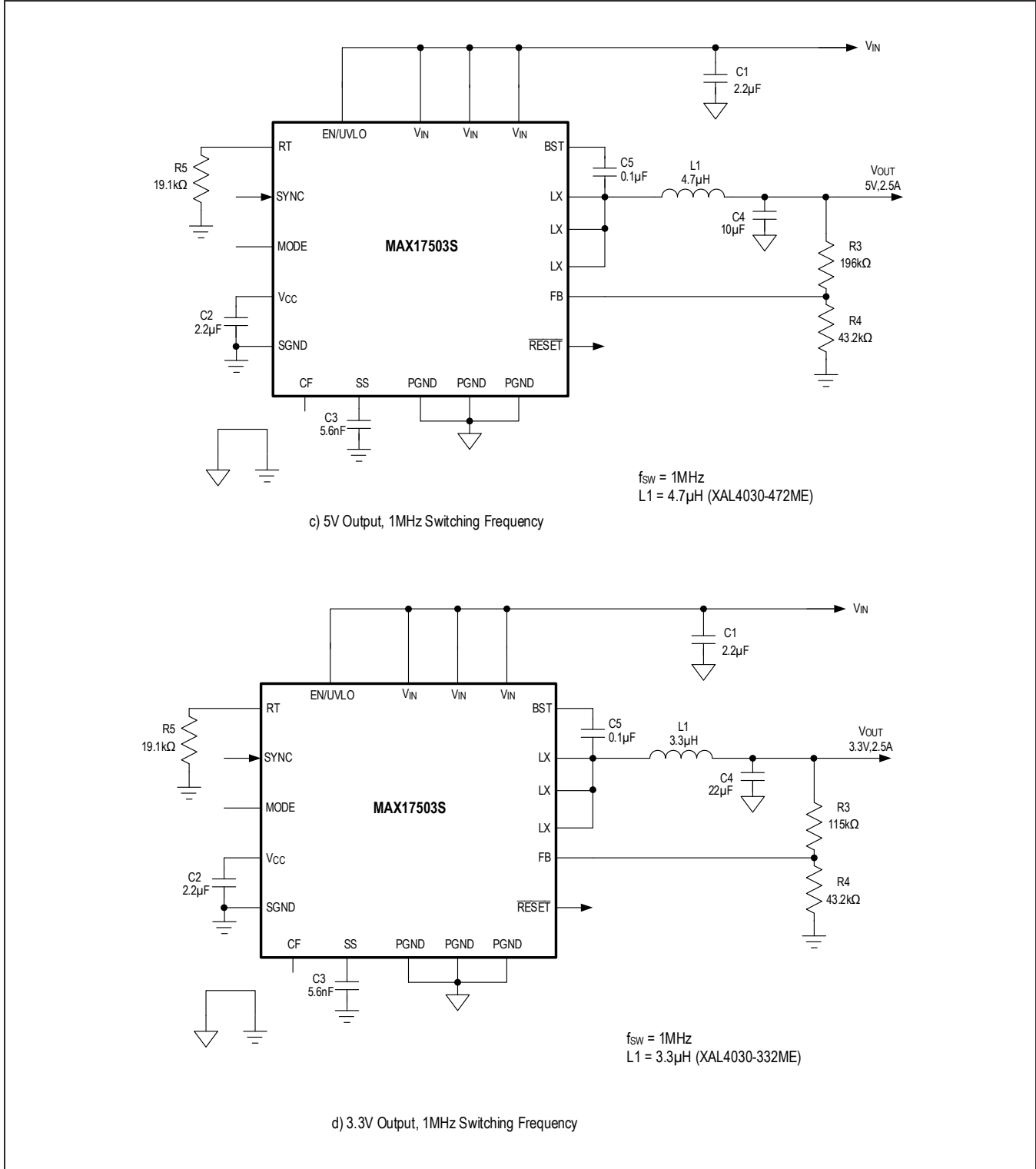

Figure 4. MAX17503/MAX17503S Typical Application Circuits (continued)

# MAX17503

## 4.5V-60V, 2.5A, High-Efficiency, Synchronous Step-Down DC-DC Converter With Internal Compensation

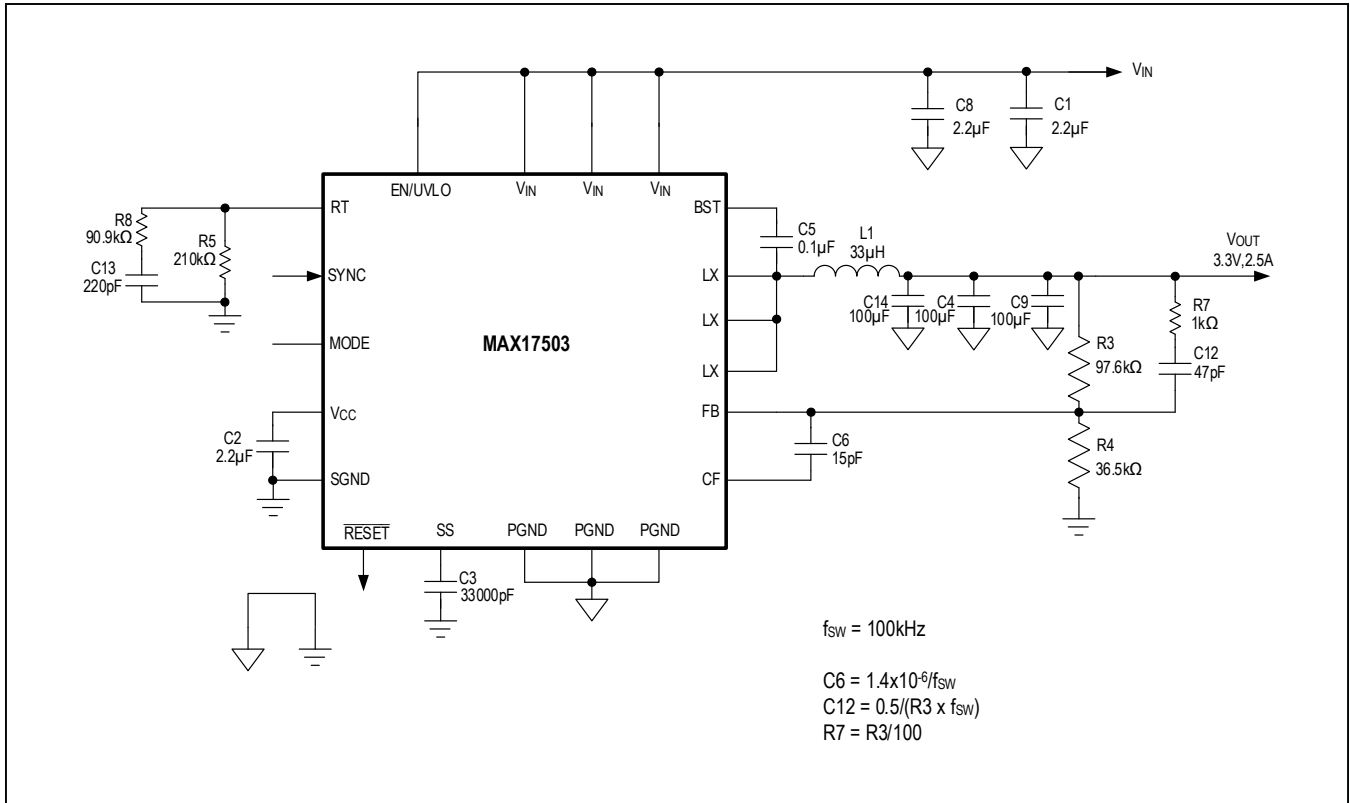

Figure 5. MAX17503/MAX17503S Typical Application Circuit—3.3V Output, 100kHz Switching Frequency

### Ordering Information

PART	PIN-PACKAGE
MAX17503ATP+	20 TQFN-EP* (4mm x 4mm)
MAX17503ATP+T	20 TQFN-EP* (4mm x 4mm)
MAX17503SATP+	20 TQFN-EP* (4mm x 4mm)
MAX17503SATP+T	20 TQFN-EP* (4mm x 4mm)

**Note:** All devices operate over the -40°C to +125°C temperature range, unless otherwise noted.

+Denotes a lead(Pb)-free/RoHS-compliant package.

\*EP = Exposed pad.

T = Tape and Reel

### Chip Information

PROCESS: BiCMOS

## Revision History

REVISION NUMBER	REVISION DATE	DESCRIPTION	PAGES CHANGED
0	8/13	Initial release	—
1	4/14	Added description and schematic for operation at 100kHz frequency	1-9, 12-13, 15, 18
2	10/16	Added MAX17503S to data sheet, updated junction temperature, and added TOCs	1-17
3	4/17	Updated data sheet title	1-27
3.1		Corrected typos	15, 17-18, 21
4	4/21	Updated <i>General Description, Benefits and Features, Package Information, toc31, toc31a, Pin Configuration, Pin Description, Detailed Description, Figure 4, Figure 5, and Ordering Information</i>	1, 2, 14, 15, 17, 18, 24, 26

For pricing, delivery, and ordering information, please visit Maxim Integrated's online storefront at <https://www.maximintegrated.com/en/storefront/storefront.html>.

Maxim cannot assume responsibility for use of any circuitry other than circuitry entirely embodied in a Maxim product. No circuit patent licenses are implied. Maxim reserves the right to change the circuitry and specifications without notice at any time. The parametric values (min and max limits) shown in the Electrical Characteristics table are guaranteed. Other parametric values quoted in this data sheet are provided for guidance.