

# ON Semiconductor

## Is Now

The logo for onsemi, featuring the word "onsemi" in a dark teal, lowercase, sans-serif font. The letter "i" is stylized with a white dot and a teal vertical bar. A small orange triangle is positioned above the top right of the "i". A trademark symbol (TM) is located to the right of the logo.

To learn more about onsemi™, please visit our website at  
[www.onsemi.com](http://www.onsemi.com)

---

**onsemi** and **onsemi** and other names, marks, and brands are registered and/or common law trademarks of Semiconductor Components Industries, LLC dba "**onsemi**" or its affiliates and/or subsidiaries in the United States and/or other countries. **onsemi** owns the rights to a number of patents, trademarks, copyrights, trade secrets, and other intellectual property. A listing of **onsemi** product/patent coverage may be accessed at [www.onsemi.com/site/pdf/Patent-Marking.pdf](http://www.onsemi.com/site/pdf/Patent-Marking.pdf). **onsemi** reserves the right to make changes at any time to any products or information herein, without notice. The information herein is provided "as-is" and **onsemi** makes no warranty, representation or guarantee regarding the accuracy of the information, product features, availability, functionality, or suitability of its products for any particular purpose, nor does **onsemi** assume any liability arising out of the application or use of any product or circuit, and specifically disclaims any and all liability, including without limitation special, consequential or incidental damages. Buyer is responsible for its products and applications using **onsemi** products, including compliance with all laws, regulations and safety requirements or standards, regardless of any support or applications information provided by **onsemi**. "Typical" parameters which may be provided in **onsemi** data sheets and/or specifications can and do vary in different applications and actual performance may vary over time. All operating parameters, including "Typicals" must be validated for each customer application by customer's technical experts. **onsemi** does not convey any license under any of its intellectual property rights nor the rights of others. **onsemi** products are not designed, intended, or authorized for use as a critical component in life support systems or any FDA Class 3 medical devices or medical devices with a same or similar classification in a foreign jurisdiction or any devices intended for implantation in the human body. Should Buyer purchase or use **onsemi** products for any such unintended or unauthorized application, Buyer shall indemnify and hold **onsemi** and its officers, employees, subsidiaries, affiliates, and distributors harmless against all claims, costs, damages, and expenses, and reasonable attorney fees arising out of, directly or indirectly, any claim of personal injury or death associated with such unintended or unauthorized use, even if such claim alleges that **onsemi** was negligent regarding the design or manufacture of the part. **onsemi** is an Equal Opportunity/Affirmative Action Employer. This literature is subject to all applicable copyright laws and is not for resale in any manner. Other names and brands may be claimed as the property of others.

# NCP58300

## 3.0A, Very Low-Dropout (VLDO) Fast Transient Response Regulator series

The NCP58300 series are high precision, very low dropout (VLDO), low ground current positive voltage regulators that are capable of providing an output current in excess of 3.0 A with a typical dropout voltage lower than 370 mV at 3.0 A load current. The devices are stable with tantalum output capacitors. This series consists initially of an Adjustable output voltage version, with fixed voltage versions planned in the future.

The NCP58300 series can withstand up to 18 V max input voltage. Internal protection features consist of output current limiting, built-in thermal shutdown and reverse output current protection. Logic level enable and error flag pins are available on the 5-pin version.

The NCP58302 is an Adjustable voltage Device and is offered in D2PAK-5 package.

### Features

- Output Current in Excess of 3.0 A
- 370 mV Typical Dropout Voltage at 3.0 A
- Adjustable and Fixed Output Voltage Options
- Low Ground Current
- Fast Transient Response
- Stable with Tantalum Output Capacitor
- Logic Compatible Enable and Error Flag Pins
- Current Limit, Reverse Current and Thermal Shutdown Protection
- Operation up to 13.5 V Input Voltage
- Adjustable Device Output Voltage Range from 1.24 V to 12.9 V
- NCV Prefix for Automotive and Other Applications Requiring Unique Site and Control Change Requirements; AEC-Q100 Qualified and PPAP Capable
- These Devices are Pb-Free and are RoHS Compliant

### Applications

- Consumer and Industrial Equipment Point of Regulation
- Servers and Networking Equipment
- FPGA, DSP and Logic Power supplies
- Switching Power Supply Post Regulation
- Battery Chargers
- Functional Replacement for Industry Standard MIC29300, MIC39300, MIC37300



ON Semiconductor®

<http://onsemi.com>

### MARKING DIAGRAMS

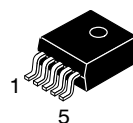

D<sup>2</sup>PAK  
CASE 936A

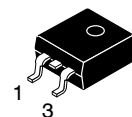
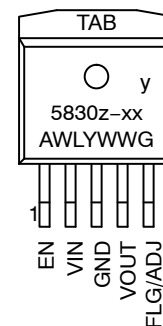

D<sup>2</sup>PAK3  
CASE 936

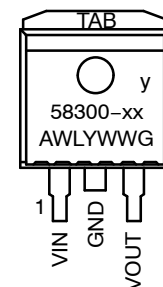

xx = Voltage Version  
y = P (NCP), V (NCV)  
z = 1 (Fix Voltage), 2 (Adj)  
A = Assembly Location  
WL = Wafer Lot  
Y = Year  
WW = Work Week  
G = Pb-Free Package

### ORDERING INFORMATION

See detailed ordering and shipping information in the package dimensions section on page 10 of this data sheet.

# NCP58300

## TYPICAL APPLICATIONS

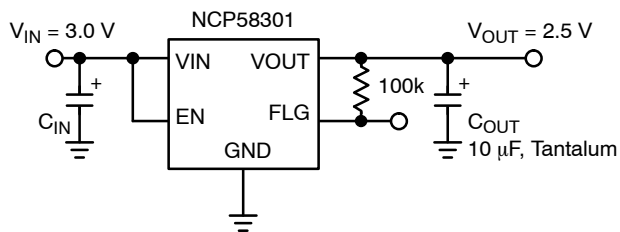

Figure 1. Fixed 2.5 Regulator with Error Flag

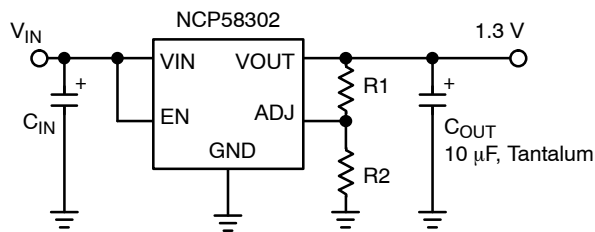

Figure 2. Adjustable Regulator

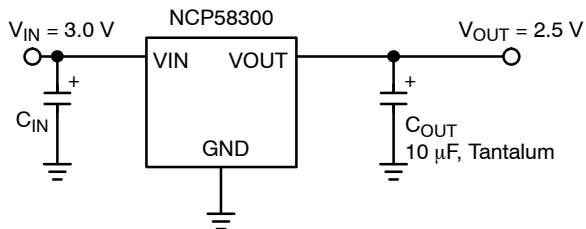

Figure 3. Fixed 2.5 Regulator in D<sup>2</sup>PAK-3 Package

### PIN FUNCTION DESCRIPTION

| Pin Number<br>D2PAK-5 | Pin Number<br>D2PAK-3 | Pin Name | Pin Function   |
|-----------------------|-----------------------|----------|--|
| 1                     | -                     | EN       | Enable Input: CMOS and TTL logic compatible. Logic high = enable; Logic low = shutdown.          |
| 2                     | 1                     | VIN      | Input voltage which supplies both the internal circuitry and the current to the output load      |
| 3                     | 2                     | GND      | Ground   |
| TAB                   | TAB                   | TAB      | TAB is connected to ground.  |
| 4                     | 3                     | VOUT     | Linear Regulator Output.   |
| 5 (Fixed)             | -                     | FLG      | Error Flag Open collector output.<br>Active-low indicates an output fault condition.             |
| 5 (Adj)               | -                     | ADJ      | Adjustable Regulator Feedback Input.<br>Connect to output voltage resistor divider central node. |

# NCP58300

## ABSOLUTE MAXIMUM RATINGS

| Symbol                             | Rating   | Value                             | Unit        |   |
|------------------------------------|--|-----------------------------------|-------------|---|
| V <sub>IN</sub>                    | Supply Voltage   | 0 to 18                           | V           |   |
| V <sub>EN</sub>                    | Enable Input Voltage   | 0 to 18                           | V           |   |
| V <sub>FLG</sub>                   | Error Flag open collector output Max. voltage  | 0 to 18                           | V           |   |
| V <sub>OUT</sub> – V <sub>IN</sub> | Reverse V <sub>OUT</sub> – V <sub>IN</sub> Voltage (EN = Shutdown or V <sub>IN</sub> = 0 V) (Note 1) | 0 to 6.5                          | V           |   |
| P <sub>D</sub>                     | Power Dissipation (Notes 2 and 5)  | Internally Limited                |             |   |
| T <sub>J</sub>                     | Junction Temperature   | –40 ≤ T <sub>J</sub> ≤ +125       | °C          |   |
| T <sub>S</sub>                     | Storage Temperature  | –65 ≤ T <sub>J</sub> ≤ +150       | °C          |   |
|                                    | ESD Rating (Notes 3 and 4)   | Human Body Model<br>Machine Model | 2000<br>200 | V |

Stresses exceeding Maximum Ratings may damage the device. Maximum Ratings are stress ratings only. Functional operation above the Recommended Operating Conditions is not implied. Extended exposure to stresses above the Recommended Operating Conditions may affect device reliability.

NOTE: All voltages are referenced to GND pin unless otherwise noted.

- The ENABLE pin input voltage must be ≤ 0.8 V or V<sub>IN</sub> must be connected to ground potential.
- $P_{D(max)} = (T_{J(max)} - T_A) / R_{\theta JA}$ , where R<sub>θJA</sub> depends upon the printed circuit board layout.
- Devices are ESD sensitive. Handling precautions recommended.
- This device series incorporates ESD protection and is tested by the following methods:  
ESD Human Body Model (HBM) tested per AEC – Q100 – 002 (EIA/JESD22 – A114C)  
ESD Machine Model (MM) tested per AEC – Q100 – 003 (EIA/JESD22 – A115C)  
This device contains latch – up protection and exceeds 100 mA per JEDEC Standard JESD78.
- This protection is not guaranteed outside the Recommended Operating Conditions.

## RECOMMENDED OPERATING CONDITIONS (Note 6)

| Symbol           | Rating                            | Value                       | Unit |
|------------------|-----------------------------------|-----------------------------|------|
| V <sub>IN</sub>  | Maximum Supply Voltage            | 13.5                        | V    |
| V <sub>EN</sub>  | Enable Input Voltage              | 0 to 13.5                   | V    |
| V <sub>FLG</sub> | Error Flag Open Collector Voltage | 0 to 13.5                   | V    |
| T <sub>J</sub>   | Junction Temperature              | –40 ≤ T <sub>J</sub> ≤ +125 | °C   |

- The device is not guaranteed to function outside it's Recommended operating conditions.

# NCP58300

## ELECTRICAL CHARACTERISTICS

$T_J = 25^\circ\text{C}$  with  $V_{IN} = V_{OUT\ nominal} + 1\text{ V}$ ;  $V_{EN} = V_{IN}$ ;  $I_L = 10\text{ mA}$ ; **bold** values indicate  $-40^\circ\text{C} < T_J < +125^\circ\text{C}$ , unless noted.

| Parameter  | Conditions  | Min       | Typ       | Max                    | Unit                  |
|--|---|-----------|-----------|------------------------|-----------------------|
| Output Voltage Accuracy  | $I_L = 10\text{ mA}$  | -1        |           | +1                     | %                     |
|  | $10\text{ mA} < I_{OUT} < 3.0\text{ A}$ , $V_{OUT\ nominal} + 1 \leq V_{IN} \leq 13.5\text{ V}$ | <b>-2</b> |           | <b>+2</b>              | %                     |
| Output Voltage Line Regulation                                 | $V_{IN} = V_{OUT\ nominal} + 1.0\text{ V}$ to $13.5\text{ V}$ ; $I_L = 10\text{ mA}$            |           | 0.06      | 0.5                    | %                     |
| Output Voltage Load Regulation                                 | $I_L = 10\text{ mA}$ to $3.0\text{ A}$ , $V_{IN} = V_{OUT\ nominal} + 5.0\text{ V}$             |           | 0.2       | 1                      | %                     |
| $\Delta V_o / \Delta T$  | Output Voltage Temperature Coefficient (Note 9)   |           | <b>20</b> | <b>100</b>             | ppm/ $^\circ\text{C}$ |
| $V_{IN} - V_{OUT}$ Dropout Voltage (Note 7)                    | $I_L = 100\text{ mA}$   |           | 80        | <b>175</b>             | mV                    |
|  | $I_L = 1.5\text{ A}$  |           | 250       |                        | mV                    |
|  | $I_L = 3.0\text{ A}$  |           | 370       | <b>600</b>             | mV                    |
| Ground Pin Current (Note 8)                                    | $I_L = 1.5\text{ A}$ , $V_{IN} = V_{OUT\ nominal} + 1.0\text{ V}$                               |           | 25        | <b>50</b>              | mA                    |
|  | $I_L = 3.0\text{ A}$  |           | 50        |                        | mA                    |
| Ground Pin Current at Dropout                                  | $V_{IN} = V_{OUT} - 0.5\text{ V}$ , $I_L = 10\text{ mA}$  |           | 1.7       |                        | mA                    |
| Ground Pin Current in Shutdown                                 | $V_{EN} \leq 0.4\text{ V}$  |           | 2.0       | <b>10</b><br><b>30</b> | $\mu\text{A}$         |
| Overload Protection Current Limit                              | $V_{OUT} = 0\text{ V}$ , $V_{IN} = V_{OUT\ nominal} + 1.0\text{ V}$                             |           | 4.5       |                        | A                     |
| Output Noise Voltage (10 Hz to 100 kHz), $I_L = 100\text{ mA}$ | $C_{OUT} = 10\text{ }\mu\text{F}$   |           | 400       |                        | $\mu\text{V}$         |
|  | $C_{OUT} = 33\text{ }\mu\text{F}$   |           | 260       |                        | (rms)                 |

## FLAG OUTPUT

|  |  |                 |      |                      |               |
|--|--|-----------------|------|----------------------|---------------|
| Output Leakage Current $I_{flg(Leak)}$ | $V_{oh} = 13.5\text{ V}$   |                 | 0.01 | <b>1</b><br><b>2</b> | $\mu\text{A}$ |
| Output Low Voltage $V_{FLG(LO)}$       | Device set for $5\text{ V}$ , $V_{IN} = 4.5\text{ V}$ , $I_{FLG} = 250\text{ }\mu\text{A}$ |                 | 220  | 300<br><b>400</b>    | mV            |
| Upper Threshold Voltage                | Device set for $5\text{ V}$ (Note 11)  | 40<br><b>25</b> | 60   |                      | mV            |
| Upper Threshold Voltage                | Device set for $5\text{ V}$ (Note 11)  |                 | 75   | 95<br><b>140</b>     | mV            |
| Hysteresis                             | Device set for $5\text{ V}$ (Note 11)  |                 | 15   |                      | mV            |

## ENABLE INPUT

|                                      |   |            |     |                      |               |
|--------------------------------------|---|------------|-----|----------------------|---------------|
| Enable Input Signal Levels           | Regulator enable  | <b>2.4</b> |     |                      | V             |
|                                      | Regulator shutdown  |            |     | <b>0.8</b>           | V             |
| Enable pin Input Current             | $V_{EN} = 0.8\text{ V}$   |            |     | <b>2</b><br><b>4</b> | $\mu\text{A}$ |
|                                      | $V_{EN} = 13.5\text{ V}$  |            | 100 | 600<br><b>750</b>    | $\mu\text{A}$ |
| Regulator Output Current in Shutdown | $V_{EN} \leq 0.8\text{ V}$ and $V_{IN} \leq 13.5\text{ V}$ , $V_{OUT} = 0\text{ V}$ |            | 10  | <b>500</b>           | $\mu\text{A}$ |

# NCP58300

## ELECTRICAL CHARACTERISTICS

$T_J = 25^\circ\text{C}$  with  $V_{IN} = V_{OUT\text{ nominal}} + 1\text{ V}$ ;  $V_{EN} = V_{IN}$ ;  $I_L = 10\text{ mA}$ ; **bold** values indicate  $-40^\circ\text{C} < T_J < +125^\circ\text{C}$ , unless noted.

| Parameter                                       | Conditions | Min                   | Typ   | Max                   | Unit                  |
|---|------------|-----------------------|-------|-----------------------|-----------------------|
| <b>REFERENCE NCP58302 ONLY</b>                  |            |                       |       |                       |                       |
| Reference Voltage                               |            | 1.228<br><b>1.215</b> | 1.240 | 1.252<br><b>1.265</b> | V                     |
| Adjust Pin Bias Current                         |            |                       | 50    | <b>120</b>            | nA                    |
| Reference Voltage Temperature Coefficient       | (Note 10)  |                       | 20    |                       | ppm/ $^\circ\text{C}$ |
| Adjust Pin Bias Current Temperature Coefficient |            |                       | 0.1   |                       | nA/ $^\circ\text{C}$  |

7.  $V_{DO} = V_{IN} - V_{OUT}$  when  $V_{OUT}$  decreases to 99% of its nominal output voltage with  $V_{IN} = V_{OUT} + 1\text{ V}$ .

8.  $I_{IN} = I_{GND} + I_{OUT}$ .

9. Output Voltage Temperature Coefficient is defined as worst case voltage change divided by the total temperature range. Guaranteed by design.

10. Thermal regulation is defined as the change in output voltage at a time T after a change in power dissipation is applied, excluding load or line regulation effects. Specifications are for a 4 W pulse for T = 10 ms.

11. Comparator thresholds are expressed in terms of a voltage differential at the Adjust terminal below the nominal reference voltage measured at 6V input. To express these thresholds in terms of output voltage change, multiply by the error amplifier gain =  $V_{OUT}/V_{REF} = (R1 + R2)/R2$ . For example, at a programmed output voltage of 5 V, the Error output is guaranteed to go low when the output drops by  $95\text{ mV} \times 5\text{ V}/1.240\text{ V} = 384\text{ mV}$ . Thresholds remain constant as a percent of  $V_{OUT}$  as  $V_{OUT}$  is varied, with the dropout warning occurring at typically 5% below nominal, 7.7% guaranteed.

| Package                   | Conditions / PCB Footprint | Thermal Resistance                    |
|---------------------------|----------------------------|---------------------------------------|
| D2PAK-3, Junction-to-Case |                            | $R_{\theta JC} = 2.0^\circ\text{C/W}$ |
| D2PAK-5, Junction-to-Case |                            | $R_{\theta JC} = 2.0^\circ\text{C/W}$ |

# NCP58300

## TYPICAL CHARACTERISTICS

$T_J = 25^\circ\text{C}$  if not otherwise noted

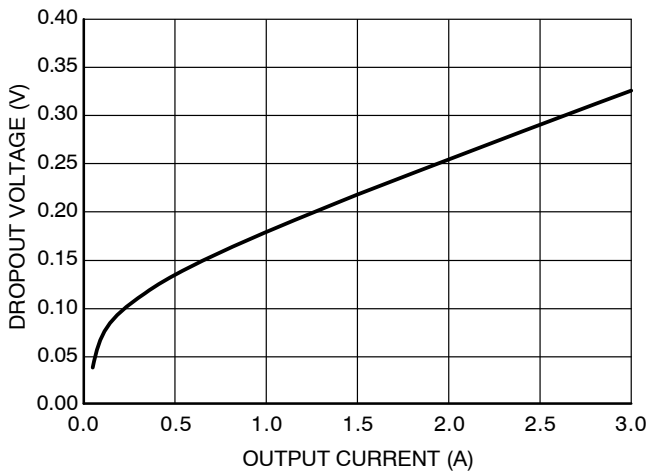

Figure 4. Dropout Voltage vs. Output Current

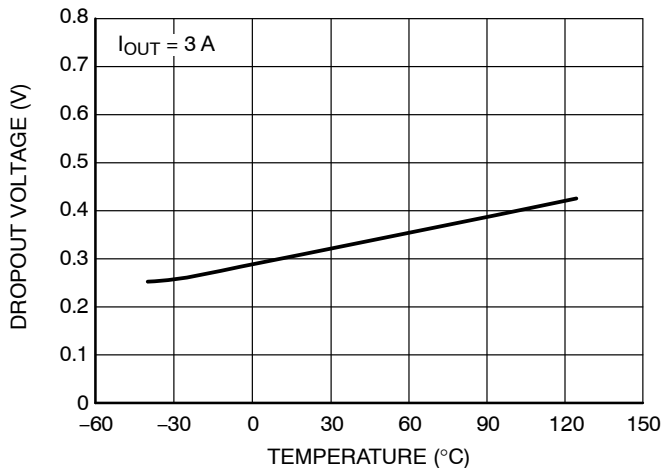

Figure 5. Dropout Voltage vs. Temperature

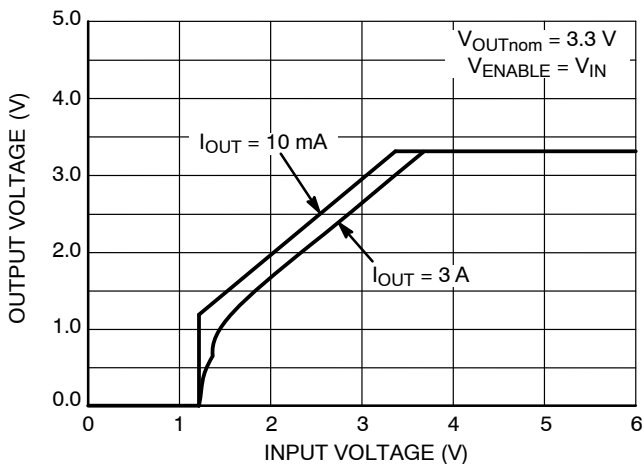

Figure 6. Dropout Characteristics

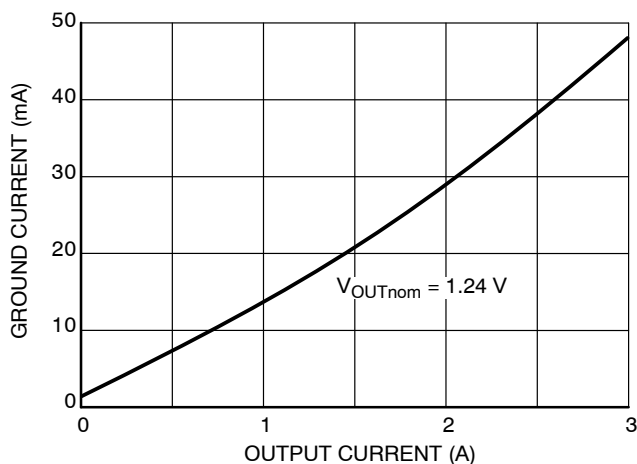

Figure 7. Ground Current vs. Output Current

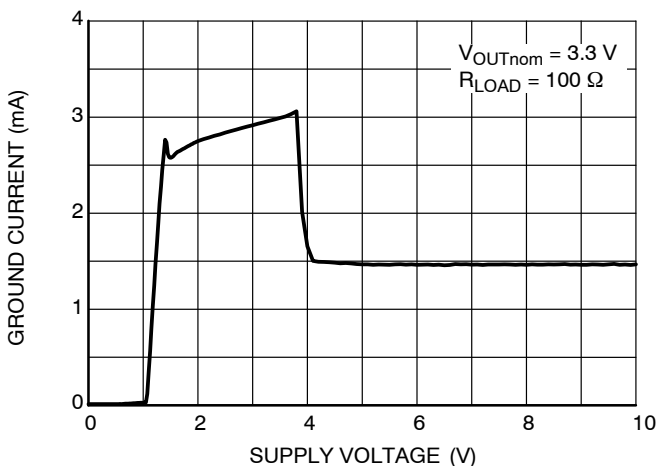

Figure 8. Ground Current vs. Supply Voltage

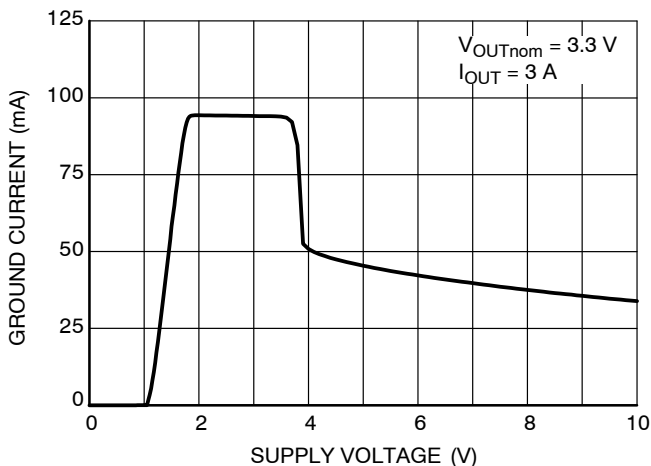

Figure 9. Ground Current vs. Supply Voltage

# NCP58300

## TYPICAL CHARACTERISTICS

$T_J = 25^\circ\text{C}$  if not otherwise noted

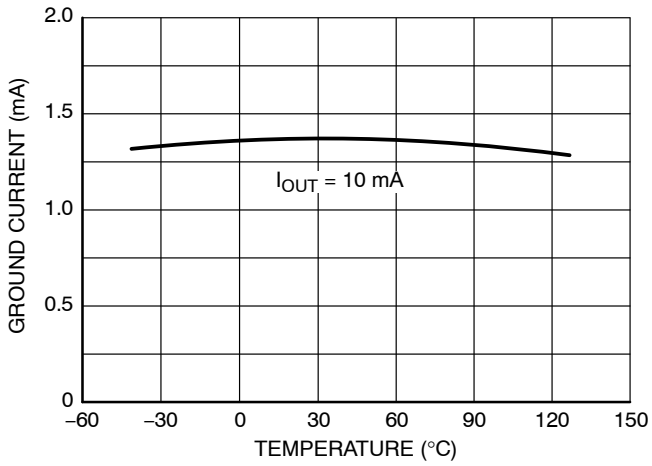

Figure 10. Ground Current vs. Temperature

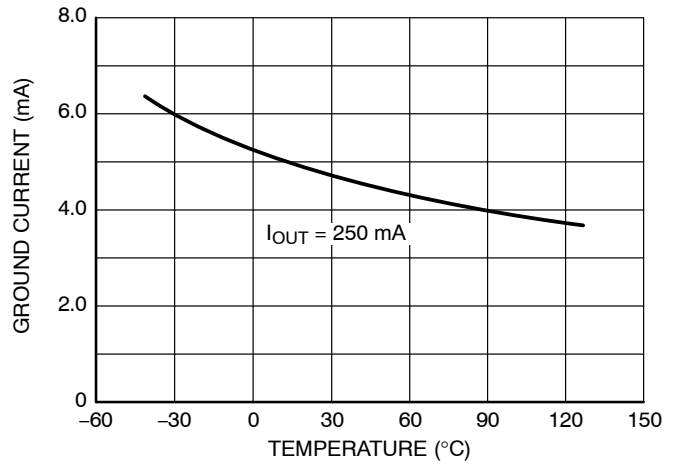

Figure 11. Ground Current vs. Temperature

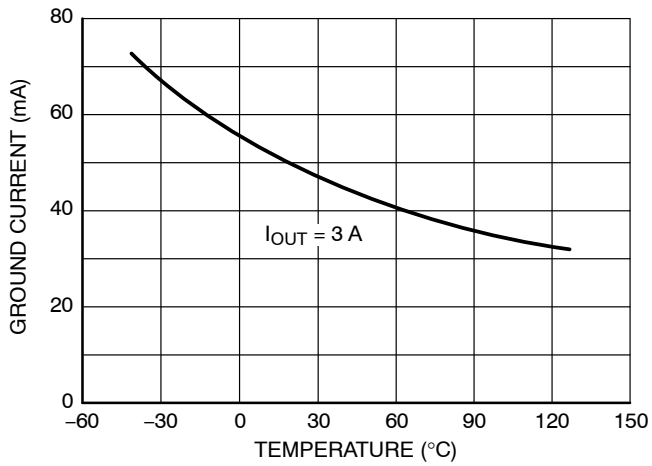

Figure 12. Ground Current vs. Temperature

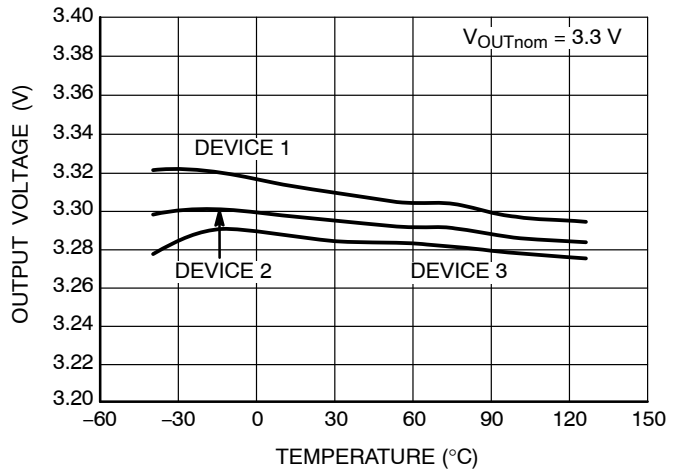

Figure 13. Output Voltage vs. Temperature

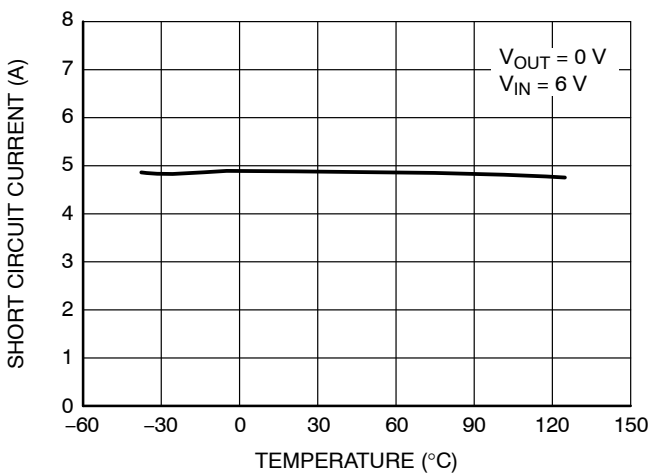

Figure 14. Short Circuit Current vs. Temperature

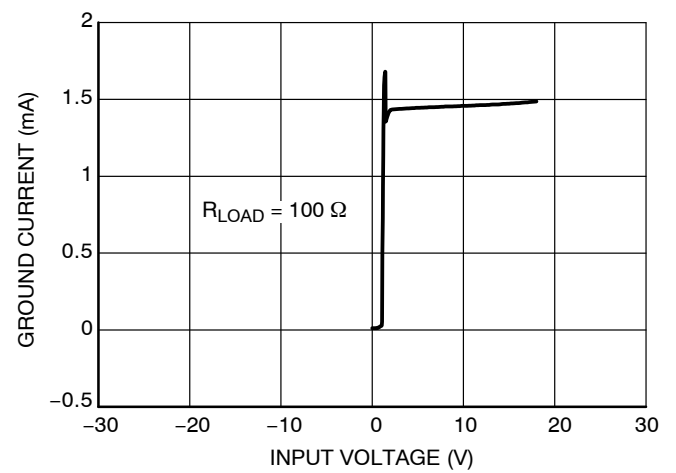

Figure 15. Ground Current vs. Input Voltage



# NCP58300

## TYPICAL CHARACTERISTICS

$T_J = 25^\circ\text{C}$  if not otherwise noted

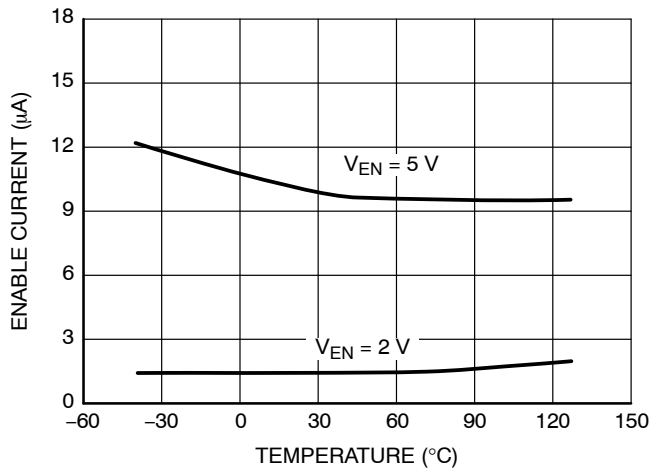

Figure 16. Enable Current vs. Temperature

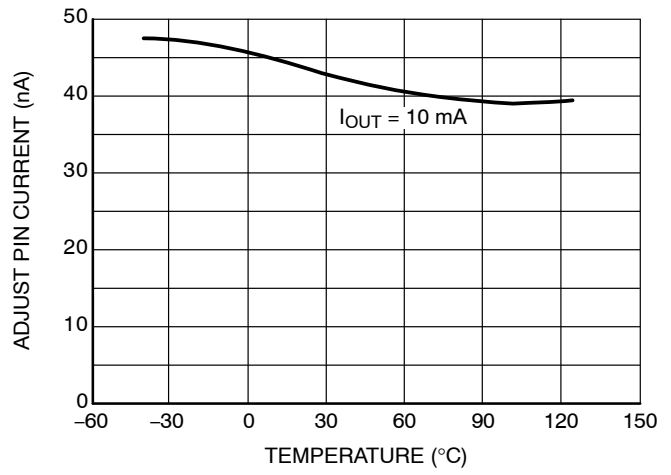

Figure 17. Adjust Pin Current vs. Temperature

APPLICATIONS INFORMATION

**Output Capacitor and Stability**

The NCP58300 series requires an output capacitor for stable operation. The NCP58300 series is designed to operate with tantalum output capacitors. The recommended output capacitance value is 10  $\mu\text{F}$  or greater. Higher value helps to improve transient response and noise reduction. The value of output capacitor is dependent upon the output current; lower currents allow smaller capacitors.

**Input Capacitor**

An input capacitor of 0.1  $\mu\text{F}$  or greater is recommended when the device is more than 4 inches away from the bulk supply capacitance, or when the supply is a battery. Small, surface-mount chip capacitors can be used for the bypassing. The capacitor should be placed within 1 inch of the device for optimal performance. Larger values will help to improve ripple rejection by bypassing the input of the regulator, further improving the integrity of the output voltage.

**Minimum Load Current**

The NCP58300 regulator is specified between finite loads. A 7 mA minimum load current is necessary for proper operation.

**Error Flag**

Some NCP58300 series members feature an error flag circuit that monitors the output voltage and signals an error condition when the voltage is 5% below the nominal output voltage. The error flag is an open-collector output that can sink up to 10 mA during a  $V_{\text{OUT}}$  fault condition. The FLG output is overload protected when a short circuit of the pullup load resistor occurs in the application. This is guaranteed in the full range of FLG output voltage Max ratings (see Max Ratings table).

**Enable Input**

Some NCP58300 series members also feature an enable input for on/off control of the device. Its shutdown state draws “zero” current from input voltage supply (only microamperes of leakage). The enable input is TTL/CMOS compatible for simple logic interface, but can be connected up to  $V_{\text{IN}}$ .

**Overcurrent and Reverse Output Current Protection**

The NCP58300 regulator is fully protected from damage due to output current overload conditions. When NCP58300 output is overloaded, Output Current limiting is provided. This limiting is linear; output current during overload conditions is constant. The device is also capable to withstand power-on or enable start-up with output shorted to ground for the full Recommended Operating Conditions range. These features are advantageous for powering FPGAs and other ICs having current consumption higher than nominal during their startup.

Thermal shutdown disables the NCP58300 device when the die temperature exceeds the maximum safe operating temperature.

When NCP58300 is disabled and ( $V_{\text{OUT}} - V_{\text{IN}}$ ) voltage difference is less than 6.5 V in the application, the output structure of these regulators is able to withstand output voltage (backup battery as example) to be applied without reverse current flow. Of course the additional current flowing through the internal Feedback resistor divider at the NCP58300 Fix voltage versions needs to be included in the backup battery discharging calculations.

**Adjustable Voltage Design**

The NCP/NCV58302 Adjustable voltage Device Output voltage is set by the ratio of two external resistors as shown in Figure 18. The device maintains the voltage at the ADJ pin at 1.24 V referenced to ground. The current in R2 is then equal to  $1.24 \text{ V} / R_2$ , and the current in R1 is the current in R2 plus the ADJ pin bias current. The ADJ pin bias current flows from  $V_{\text{OUT}}$  through R1 into the ADJ pin.

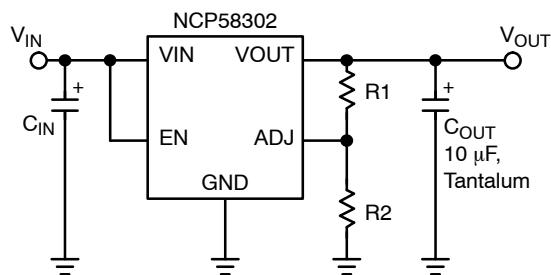

$$V_{\text{OUT}} = 1.24 \text{ V} \cdot \left( 1 + \frac{R_1}{R_2} \right) + I_{\text{ADJ}} \cdot R_1$$

**Figure 18. Adjustable Voltage Operation**

For the R2 resistor value up to 15 k $\Omega$  the  $I_{\text{ADJ}}$  current impact can be neglected and the R1 resistor value can be calculated y:

$$R_1 = R_2 \times \left( \frac{V_{\text{OUT}}}{1.24} - 1 \right) \quad (\text{eq. 1})$$

Where  $V_{\text{OUT}}$  is the desired nominal output voltage.

**Thermal Considerations**

The power handling capability of the device is limited by the maximum rated junction temperature (125°C). The  $P_{\text{D}}$  total power dissipated by the device has two components, Input to output voltage differential multiplied by Output current and Input voltage multiplied by GND pin current.

$$P_{\text{D}} = (V_{\text{IN}} - V_{\text{OUT}}) \cdot I_{\text{OUT}} + V_{\text{IN}} \cdot I_{\text{GND}} \quad (\text{eq. 2})$$

The GND pin current value can be found in Electrical Characteristics table and in Typical Characteristics graphs. The Junction temperature  $T_{\text{J}}$  is

$$T_{\text{J}} = T_{\text{A}} + P_{\text{D}} \cdot R_{\theta\text{JA}} \quad (\text{eq. 3})$$

where  $T_{\text{A}}$  is ambient temperature and  $R_{\theta\text{JA}}$  is the Junction to Ambient Thermal Resistance of the NCP/NCV58300 device mounted on the specific PCB.

# NCP58300

## ORDERING INFORMATION

| Device           | Output Current | Output Voltage | Junction Temp. Range | Package                           | Shipping <sup>†</sup> |
|------------------|----------------|----------------|----------------------|-----------------------------------|-----------------------|
| NCP58302DSADJR4G | 3.0 A          | ADJ            | -40°C to +125°C      | D <sup>2</sup> PAK-5<br>(Pb-Free) | 800 / Tape & Reel     |

<sup>†</sup>For information on tape and reel specifications, including part orientation and tape sizes, please refer to our Tape and Reel Packaging Specifications Brochure, BRD8011/D.

# NCP58300

## PACKAGE DIMENSIONS

D<sup>2</sup>PAK 5  
CASE 936A-02  
ISSUE D

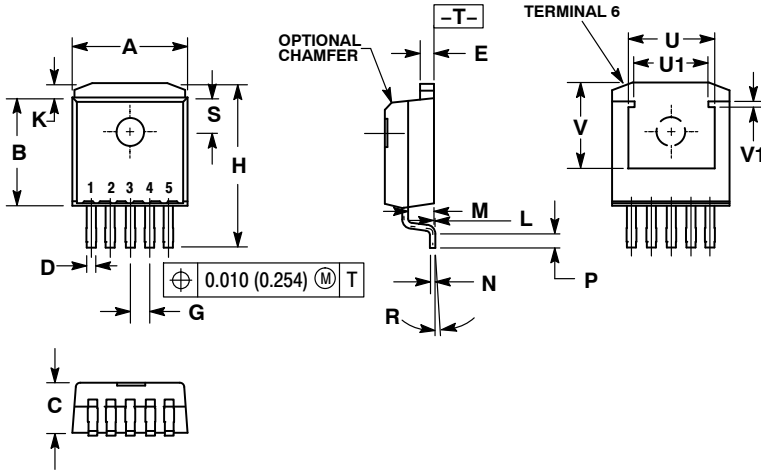

NOTES:

1. DIMENSIONING AND TOLERANCING PER ANSI Y14.5M, 1982.
2. CONTROLLING DIMENSION: INCH.
3. TAB CONTOUR OPTIONAL WITHIN DIMENSIONS A AND K.
4. DIMENSIONS U AND V ESTABLISH A MINIMUM MOUNTING SURFACE FOR TERMINAL 6.
5. DIMENSIONS A AND B DO NOT INCLUDE MOLD FLASH OR GATE PROTRUSIONS. MOLD FLASH AND GATE PROTRUSIONS NOT TO EXCEED 0.025 (0.635) MAXIMUM.

| DIM | INCHES    |       | MILLIMETERS |        |
|-----|-----------|-------|-------------|--------|
|     | MIN       | MAX   | MIN         | MAX    |
| A   | 0.386     | 0.403 | 9.804       | 10.236 |
| B   | 0.356     | 0.368 | 9.042       | 9.347  |
| C   | 0.170     | 0.180 | 4.318       | 4.572  |
| D   | 0.026     | 0.036 | 0.660       | 0.914  |
| E   | 0.045     | 0.055 | 1.143       | 1.397  |
| G   | 0.067 BSC |       | 1.702 BSC   |        |
| H   | 0.539     | 0.579 | 13.691      | 14.707 |
| K   | 0.050 REF |       | 1.270 REF   |        |
| L   | 0.000     | 0.010 | 0.000       | 0.254  |
| M   | 0.088     | 0.102 | 2.235       | 2.591  |
| N   | 0.018     | 0.026 | 0.457       | 0.660  |
| P   | 0.058     | 0.078 | 1.473       | 1.981  |
| R   | 5° REF    |       | 5° REF      |        |
| S   | 0.116 REF |       | 2.946 REF   |        |
| U   | 0.200 MIN |       | 5.080 MIN   |        |
| V   | 0.250 MIN |       | 6.350 MIN   |        |
| U1  | 0.297     | 0.305 | 7.544       | 7.747  |
| V1  | 0.038     | 0.046 | 0.965       | 1.168  |

### SOLDERING FOOTPRINT\*

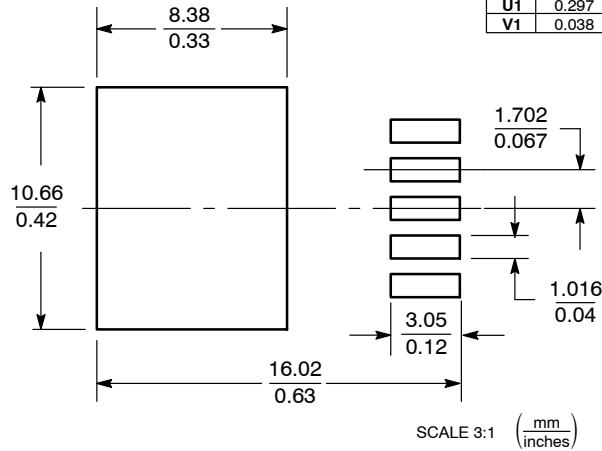

\*For additional information on our Pb-Free strategy and soldering details, please download the ON Semiconductor Soldering and Mounting Techniques Reference Manual, SOLDERRM/D.

# NCP58300

## PACKAGE DIMENSIONS

D<sup>2</sup>PAK  
CASE 936-03  
ISSUE C

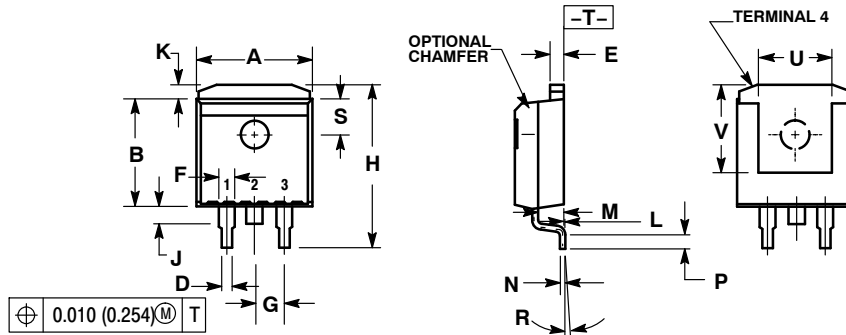

- NOTES:
1. DIMENSIONING AND TOLERANCING PER ANSI Y14.5M, 1982.
  2. CONTROLLING DIMENSION: INCH.
  3. TAB CONTOUR OPTIONAL WITHIN DIMENSIONS A AND K.
  4. DIMENSIONS U AND V ESTABLISH A MINIMUM MOUNTING SURFACE FOR TERMINAL 4.
  5. DIMENSIONS A AND B DO NOT INCLUDE MOLD FLASH OR GATE PROTRUSIONS. MOLD FLASH AND GATE PROTRUSIONS NOT TO EXCEED 0.025 (0.635) MAXIMUM.

| DIM | INCHES    |       | MILLIMETERS |        |
|-----|-----------|-------|-------------|--------|
|     | MIN       | MAX   | MIN         | MAX    |
| A   | 0.386     | 0.403 | 9.804       | 10.236 |
| B   | 0.356     | 0.368 | 9.042       | 9.347  |
| C   | 0.170     | 0.180 | 4.318       | 4.572  |
| D   | 0.026     | 0.036 | 0.660       | 0.914  |
| E   | 0.045     | 0.055 | 1.143       | 1.397  |
| F   | 0.051 REF |       | 1.295 REF   |        |
| G   | 0.100 BSC |       | 2.540 BSC   |        |
| H   | 0.539     | 0.579 | 13.691      | 14.707 |
| J   | 0.125 MAX |       | 3.175 MAX   |        |
| K   | 0.050 REF |       | 1.270 REF   |        |
| L   | 0.000     | 0.010 | 0.000       | 0.254  |
| M   | 0.088     | 0.102 | 2.235       | 2.591  |
| N   | 0.018     | 0.026 | 0.457       | 0.660  |
| P   | 0.058     | 0.078 | 1.473       | 1.981  |
| R   | 5° REF    |       | 5° REF      |        |
| S   | 0.116 REF |       | 2.946 REF   |        |
| U   | 0.200 MIN |       | 5.080 MIN   |        |
| V   | 0.250 MIN |       | 6.350 MIN   |        |

### SOLDERING FOOTPRINT\*

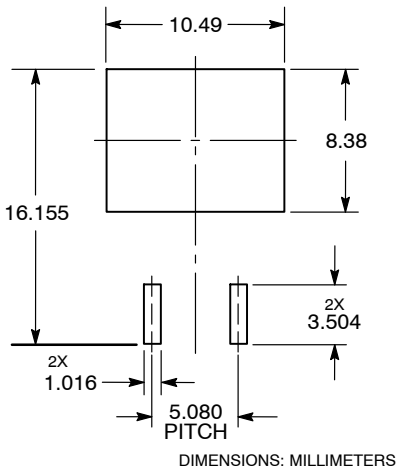

DIMENSIONS: MILLIMETERS

\*For additional information on our Pb-Free strategy and soldering details, please download the ON Semiconductor Soldering and Mounting Techniques Reference Manual, SOLDERRM/D.

ON Semiconductor and are registered trademarks of Semiconductor Components Industries, LLC (SCILLC). SCILLC owns the rights to a number of patents, trademarks, copyrights, trade secrets, and other intellectual property. A listing of SCILLC's product/patent coverage may be accessed at [www.onsemi.com/site/pdf/Patent-Marking.pdf](http://www.onsemi.com/site/pdf/Patent-Marking.pdf). SCILLC reserves the right to make changes without further notice to any products herein. SCILLC makes no warranty, representation or guarantee regarding the suitability of its products for any particular purpose, nor does SCILLC assume any liability arising out of the application or use of any product or circuit, and specifically disclaims any and all liability, including without limitation special, consequential or incidental damages. "Typical" parameters which may be provided in SCILLC data sheets and/or specifications can and do vary in different applications and actual performance may vary over time. All operating parameters, including "Typicals" must be validated for each customer application by customer's technical experts. SCILLC does not convey any license under its patent rights nor the rights of others. SCILLC products are not designed, intended, or authorized for use as components in systems intended for surgical implant into the body, or other applications intended to support or sustain life, or for any other application in which the failure of the SCILLC product could create a situation where personal injury or death may occur. Should Buyer purchase or use SCILLC products for any such unintended or unauthorized application, Buyer shall indemnify and hold SCILLC and its officers, employees, subsidiaries, affiliates, and distributors harmless against all claims, costs, damages, and expenses, and reasonable attorney fees arising out of, directly or indirectly, any claim of personal injury or death associated with such unintended or unauthorized use, even if such claim alleges that SCILLC was negligent regarding the design or manufacture of the part. SCILLC is an Equal Opportunity/Affirmative Action Employer. This literature is subject to all applicable copyright laws and is not for resale in any manner.

### PUBLICATION ORDERING INFORMATION

**LITERATURE FULFILLMENT:**  
Literature Distribution Center for ON Semiconductor  
P.O. Box 5163, Denver, Colorado 80217 USA  
**Phone:** 303-675-2175 or 800-344-3860 Toll Free USA/Canada  
**Fax:** 303-675-2176 or 800-344-3867 Toll Free USA/Canada  
**Email:** [orderlit@onsemi.com](mailto:orderlit@onsemi.com)

**N. American Technical Support:** 800-282-9855 Toll Free  
USA/Canada  
**Europe, Middle East and Africa Technical Support:**  
Phone: 421 33 790 2910  
**Japan Customer Focus Center**  
Phone: 81-3-5817-1050

**ON Semiconductor Website:** [www.onsemi.com](http://www.onsemi.com)  
**Order Literature:** <http://www.onsemi.com/orderlit>  
For additional information, please contact your local Sales Representative