



HA-5190, HA-5195

Wideband, Fast Settling Operational Amplifiers

March 1993

Features

- Fast Settling Time (0.1%) 70ns
- Very High Slew Rate 200V/ μ s
- Wide Gain-Bandwidth ($A_v \geq 5$) 150MHz
- Power Bandwidth 6.5MHz
- Low Offset Voltage 3mV
- Input Noise Voltage 6nV/ $\sqrt{\text{Hz}}$
- Bipolar D.I. Construction

Applications

- Fast, Precise D/A Converters
- High Speed Sample-Hold Circuits
- Pulse and Video Amplifiers
- Wideband Amplifiers

Ordering Information

PART NUMBER	TEMPERATURE RANGE	PACKAGE
HA1-5190-2	-55°C to +125°C	14 Lead Ceramic DIP
HA1-5195-5	0°C to +75°C	14 Lead Ceramic DIP
HA2-5190-2	-55°C to +125°C	12 Pin Can
HA2-5195-5	0°C to +75°C	12 Pin Can
HA9P5195-5	0°C to +75°C	14 Lead SOIC
HA9P5195-9	-40°C to +85°C	14 Lead SOIC

Description

HA-5190/5195 are monolithic operational amplifiers featuring a combination of speed, precision, and bandwidth. Employing monolithic bipolar construction coupled with Dielectric Isolation, these devices are capable of delivering 200V/ μ s slew rate with a settling time of 70ns (0.1%, 5V output step). These truly differential amplifiers are designed to operate at gains ≥ 5 without the need for external compensation. Other outstanding HA-5190/5195 features are 150MHz gain bandwidth product and 6.5MHz full power bandwidth. In addition to these dynamic characteristics, these amplifiers also have excellent input characteristics such as 3mV offset voltage and 6.0nV/ $\sqrt{\text{Hz}}$ input voltage noise at 1kHz.

With 200V/ μ s slew rate and 70ns settling time, these devices make ideal output amplifiers for accurate, high speed D/A converters or the main components in high speed sample/hold circuits. The 5190/5195 are also ideally suited for a variety of pulse and wideband video amplifiers. Please refer to Application Notes 525 and 528 for some of these application designs.

At temperatures above +75°C a heat sink is required for the HA-5190 (see Note 2 and Application Note 556). For military versions, please request the HA-5190/883 data sheet.

Pinouts

HA-5190/5195
(CDIP)
TOP VIEW

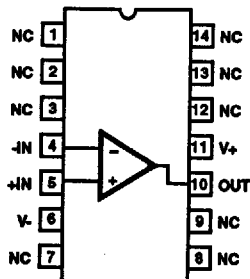

HA-5195
(SOIC)
TOP VIEW

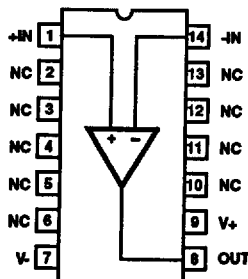

HA-5190/5195
(TO-8 METAL CAN)
TOP VIEW

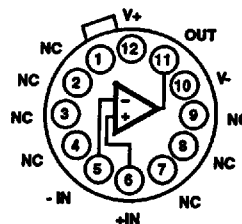

Case Tied To V-

Specifications HA-5190, HA-5195

Absolute Maximum Ratings

Voltage Between V+ and V-	35V
Differential Input Voltage	6V
Output Current	50mA (Peak)
Junction Temperature (Note 1)	+175°C
Junction Temperature (Plastic Packages)	+150°C
Lead Temperature (Soldering 10 Sec.)	+300°C

Operating Conditions

Operating Temperature Ranges	
HA-5190-2	-55°C ≤ T _A ≤ +125°C
HA-5195-5	0°C ≤ T _A ≤ +75°C
HA-5195-9	-40°C ≤ T _A ≤ +85°C
Storage Temperature Range	-65°C ≤ T _A ≤ +150°C

CAUTION: Stresses above those listed in "Absolute Maximum Ratings" may cause permanent damage to the device. This is a stress only rating and operation of the device at these or any other conditions above those indicated in the operational sections of this specification is not implied.

Electrical Specifications V_{SUPPLY} = ±15V, R_L = 200Ω, Unless Otherwise Specified

PARAMETERS	TEMP	HA-5190-2			HA-5195-5, -9			UNITS	
		MIN	TYP	MAX	MIN	TYP	MAX		
INPUT CHARACTERISTICS									
Offset Voltage	+25°C	-	3	5	-	3	6	mV	
	Full	-	-	10	-	-	10	mV	
Average Offset Voltage Drift	Full	-	20	-	-	20	-	μV/°C	
Bias Current	+25°C	-	5	15	-	5	15	μA	
	Full	-	-	20	-	-	20	μA	
Offset Current	+25°C	-	1	4	-	1	4	μA	
	Full	-	-	6	-	-	6	μA	
Input Resistance	+25°C	-	10	-	-	10	-	kΩ	
Input Capacitance	+25°C	-	1	-	-	1	-	pF	
Common Mode Range	Full	±5	-	-	±5	-	-	V	
Input Noise Current (f = 1kHz, R _g = 0Ω)	+25°C	-	5	-	-	5	-	pA/√Hz	
Input Noise Voltage (f = 1kHz, R _g = 0Ω)	+25°C	-	6	-	-	6	-	nV/√Hz	
TRANSFER CHARACTERISTICS									
Large Signal Voltage Gain (Note 2)	+25°C	15	30	-	10	30	-	kV/V	
	Full	5	-	-	5	-	-	kV/V	
Common Mode Rejection Ratio (Note 3)	Full	74	95	-	74	95	-	dB	
Minimum Stable Gain	+25°C	5	-	-	5	-	-	V/V	
Gain-Bandwidth-Product (Note 4)	+25°C	-	150	-	150	-	-	MHz	
OUTPUT CHARACTERISTICS									
Output Voltage Swing (Note 2)	Full	±5	±8	-	±5	±8	-	V	
Output Current (Note 2)	+25°C	±25	±30	-	±25	±30	-	mA	
Output Resistance	+25°C	-	30	-	-	30	-	Ω	
Full Power Bandwidth (Notes 2, 5)	+25°C	5	6.5	-	5	6.5	-	MHz	
TRANSIENT RESPONSE (Note 6)									
Rise Time	+25°C	-	13	18	-	13	18	ns	
Overshoot	+25°C	-	8	-	-	8	-	%	
Slew Rate	+25°C	160	200	-	160	200	-	V/μs	
Settling Time (Note 6)	+25°C	5V Step to 0.1%	-	70	-	-	70	-	ns
		5V Step to 0.01%	-	100	-	-	100	-	ns
		2.5V Step to 0.1%	-	50	-	-	50	-	ns
		2.5V Step to 0.01%	-	80	-	-	80	-	ns

2
OPERATIONAL AMPLIFIERS

Specifications HA-5190, HA-5195

Electrical Specifications $V_{SUPPLY} = \pm 15V$, $R_L = 200\Omega$, Unless Otherwise Specified (Continued)

PARAMETERS	TEMP	HA-5190-2			HA-5195-5, -9			UNITS
		MIN	TYP	MAX	MIN	TYP	MAX	
POWER SUPPLY CHARACTERISTICS								
Supply Current	Full	-	19	28	-	19	28	mA
Power Supply Rejection Ratio (Note 7)	Full	70	90	-	70	90	-	dB

NOTES:

1. Recommended heat sinks: For TO-8 Metal Can, Thermalloy #2240A ($\theta_{SA} = 27^\circ\text{C/W}$) or #2268B ($\theta_{SA} = 24^\circ\text{C/W}$). For 14 lead Ceramic DIP: AAVID #5602B ($\theta_{SA} = 16^\circ\text{C/W}$). See Die Characteristics section for θ_{JA}/θ_{JC} values.
2. $R_L = 200\Omega$, $C_L < 10\text{pF}$, $V_{OUT} = \pm 5V$.
3. $\Delta V_{CM} = \pm 5V$.
4. $V_{OUT} = 90\text{mV}$, $A_V = 10$.
5. Full power bandwidth guaranteed based on slew rate measurement using:
$$FPBW = \frac{\text{Slew Rate}}{2\pi V_{PEAK}}$$
6. Refer to Test Circuits section of the data sheet.
7. $\Delta V_{SUPPLY} = \pm 10\text{VDC}$ to $\pm 20\text{VDC}$.

Schematic Diagram

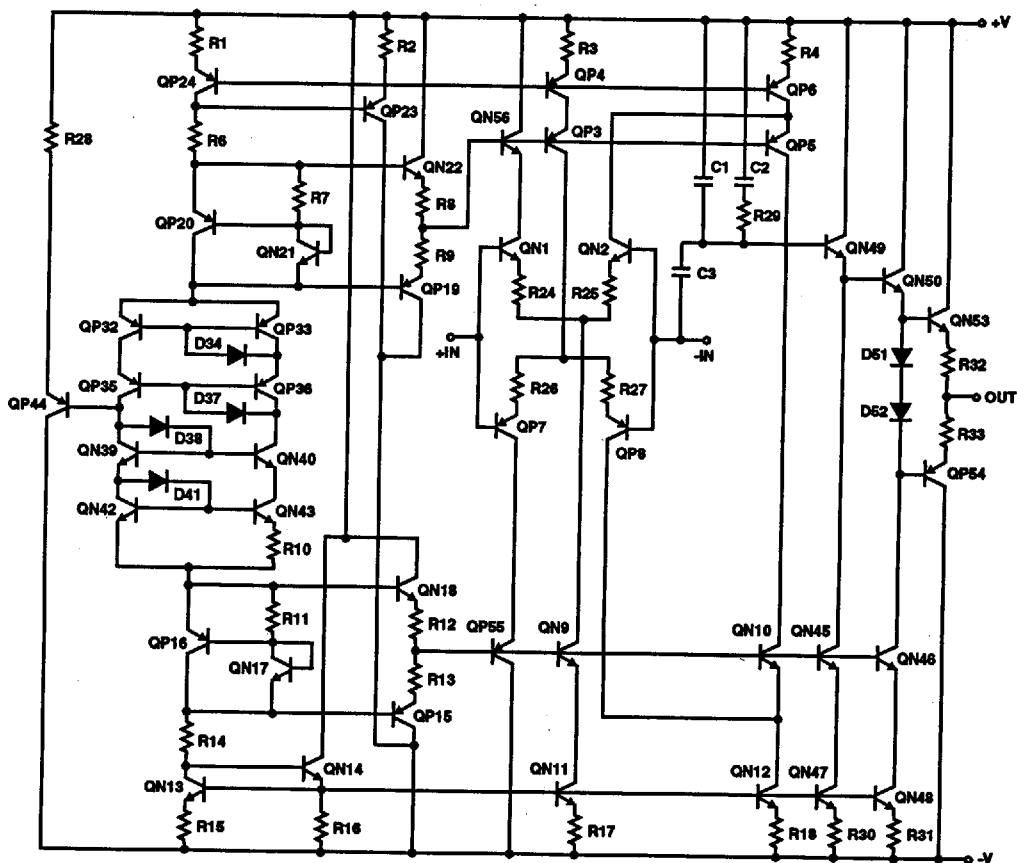

Die Characteristics

Transistor Count 49
 Die Dimensions 0.087 x 0.052 x 0.019 inches
 (2210 x 1320 x 483 mm)
 Substrate Potential (Powered Up)* V-
 Process High Frequency Bipolar Dielectric Isolation
 Passivation Nitride

Thermal Constants (°C/W)	θ_{JA}	θ_{JC}
Ceramic DIP	71	14
Metal Can	63	30
SOIC	119	36

* The substrate may be left floating (insulating Die Mount) or it may be mounted on a conductor at V- potential.

Test Circuits

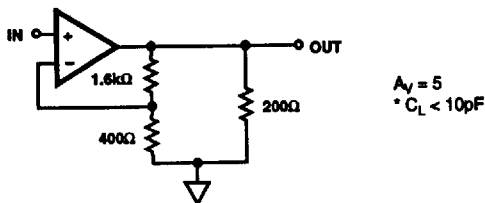
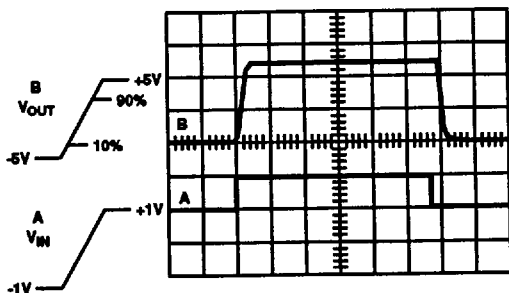

FIGURE 1. LARGE AND SMALL SIGNAL RESPONSE TEST CIRCUIT*

LARGE SIGNAL RESPONSE
 Vertical Scale: (Volts: A = 2.0V/Div., B = 4.0/Div.)
 Horizontal Scale: (Time: 100ns/Div.)



SMALL SIGNAL RESPONSE
 Vertical Scale: (Volts: A = 50mV/Div., B = 100mV/Div.)
 Horizontal Scale: (Time: 100ns/Div.)

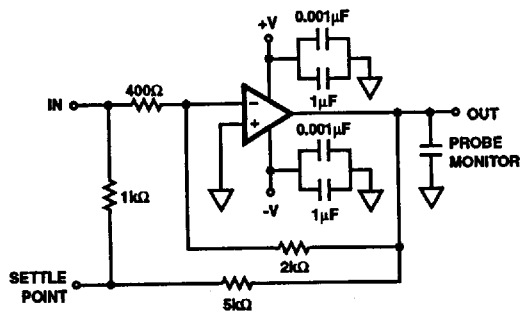
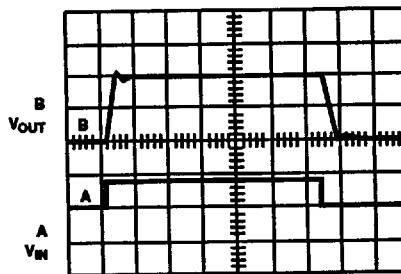

FIGURE 2. SETTLING TIME TEST CIRCUIT

- $A_V = -5$
- Load Capacitance should be less than 10pF.
- It is recommended that resistors be carbon composition and that feedback and summing network ratios be matched to 0.1%.
- Settle Point (Summing Node) capacitance should be less than 10pF. For optimum settling time results, it is recommended that the test circuit be constructed directly onto the device pins. A Tektronix 568 Sampling Oscilloscope with S-3A sampling heads is recommended as a settle point monitor.

2
OPERATIONAL AMPLIFIERS

Typical Performance Curves $V_+ = +15V, V_- = -15V, T_A = +25^\circ C$, Unless Otherwise Specified.

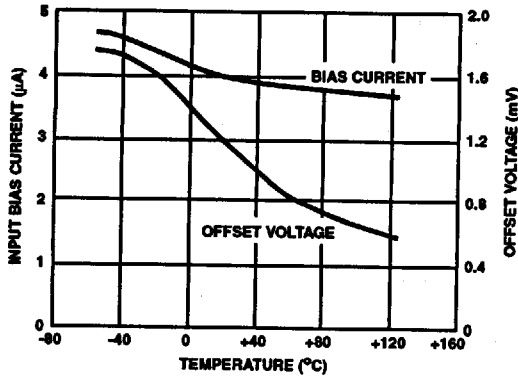

FIGURE 3. INPUT OFFSET VOLTAGE AND BIAS CURRENT vs TEMPERATURE

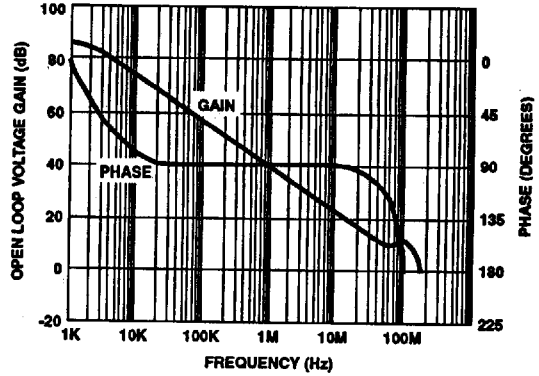

FIGURE 4. OPEN LOOP FREQUENCY RESPONSE

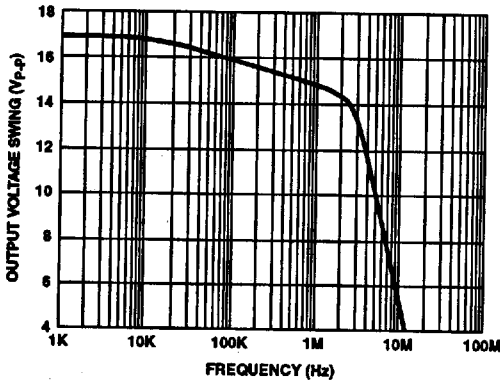

FIGURE 5. OUTPUT VOLTAGE SWING vs FREQUENCY

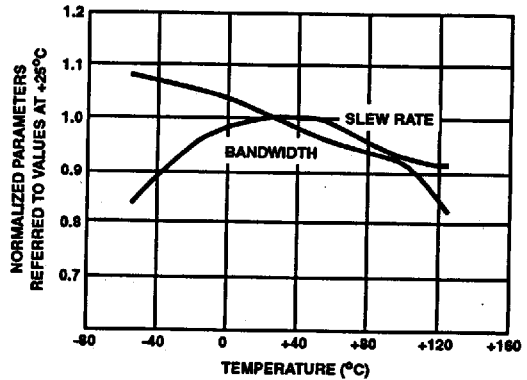

FIGURE 6. NORMALIZED AC PARAMETERS vs TEMPERATURE

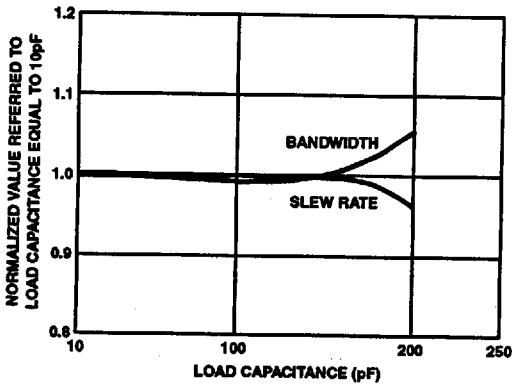

FIGURE 7. NORMALIZED AC PARAMETERS vs LOAD CAPACITANCE

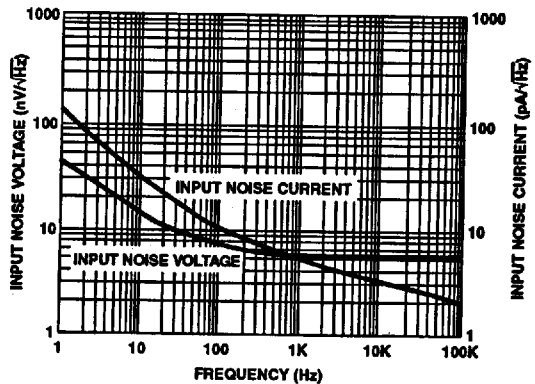

FIGURE 8. INPUT NOISE VOLTAGE AND NOISE CURRENT vs FREQUENCY

HA-5190, HA-5195

Typical Performance Curves $V_+ = +15V, V_- = -15V, T_A = +25^\circ C$, Unless Otherwise Specified. (Continued)

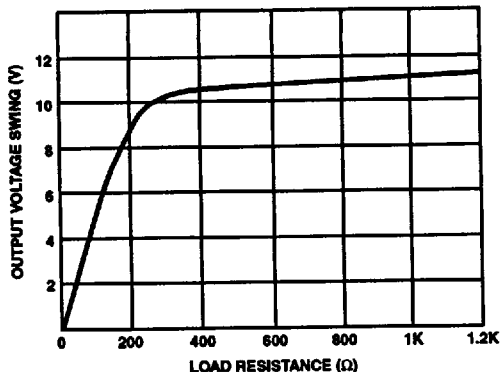

FIGURE 9. OUTPUT VOLTAGE SWING vs LOAD RESISTANCE

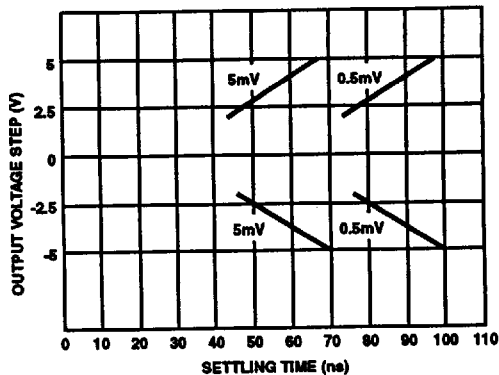

FIGURE 10. SETTLING TIME FOR VARIOUS OUTPUT STEP VOLTAGES

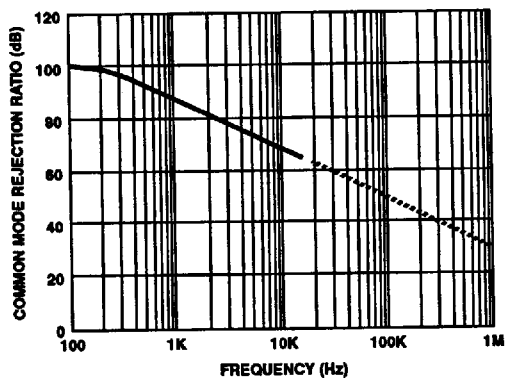

FIGURE 11. COMMON MODE REJECTION RATIO vs FREQUENCY

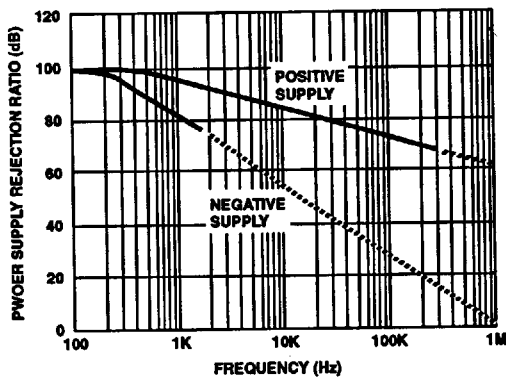

FIGURE 12. POWER SUPPLY REJECTION RATIO vs FREQUENCY

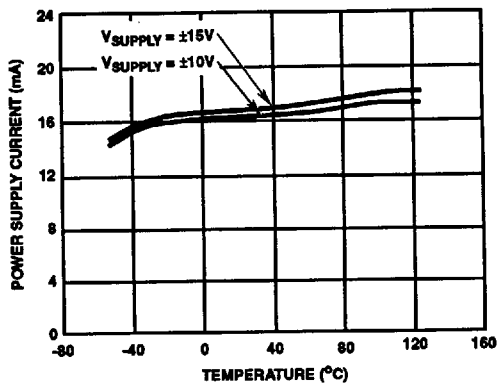

FIGURE 13. POWER SUPPLY CURRENT vs TEMPERATURE

2
OPERATIONAL AMPLIFIERS

Applying the HA-5190/5195

- 1. POWER SUPPLY DECOUPLING:** Although not absolutely necessary, it is recommended that all power supply lines be decoupled with 0.01 μ F ceramic capacitors to ground. Decoupling capacitors should be located as near to the amplifier terminals as possible.
- 2. STABILITY CONSIDERATIONS:** HA-5190/5195 is stable at gains > 5. Gains < 5 are covered below. Feedback resistors should be of carbon composition located as near to the input terminals as possible.
- 3. WIRING CONSIDERATIONS:** Video pulse circuits should be built on a ground plane. Minimum point to point connections directly to the amplifier terminals should be used. When ground planes cannot be used, good single point grounding techniques should be applied.
- 4. OUTPUT SHORT CIRCUIT:** HA-5190/5195 does not have output short circuit protection. Short circuits to ground can be tolerated for approximately 10 seconds. Short circuits to either supply will result in immediate destruction of the device.
- 5. HEAVY CAPACITIVE LOADS:** When driving heavy capacitive loads (> 100pF) a small resistor (100 Ω) should be connected in series with the output and inside the feedback loop.

Typical Applications (Also see Application Notes 525 and 526)

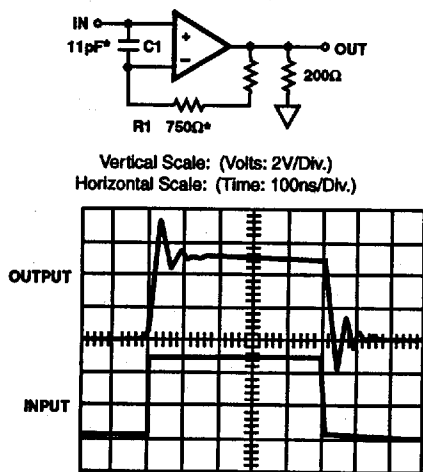

Vertical Scale: (Volts: 2V/Div.)
 Horizontal Scale: (Time: 100ns/Div.)

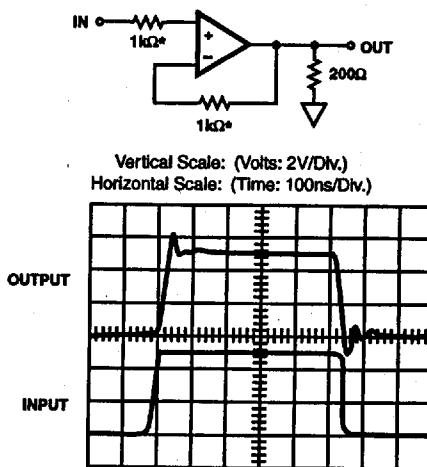

Vertical Scale: (Volts: 2V/Div.)
 Horizontal Scale: (Time: 100ns/Div.)

* Values were determined experimentally for optimum speed and settling time. R1 and C1 should be optimized for each particular application to ensure best overall frequency response.

FIGURE 14. SUGGESTED COMPENSATION FOR UNITY GAIN STABILITY: NONINVERTING

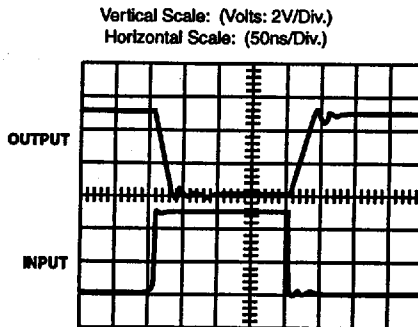
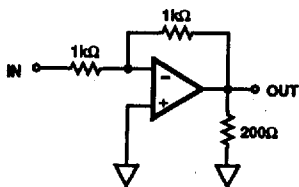

Vertical Scale: (Volts: 2V/Div.)
 Horizontal Scale: (50ns/Div.)

FIGURE 15. SUGGESTED COMPENSATION FOR INVERTING UNITY GAIN

HA-5190, HA-5195

Typical Applications (Also see Application Notes 525 and 526) (Continued)

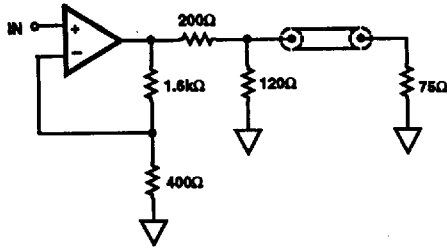

FIGURE 16. VIDEO PULSE AMPLIFIER/75Ω COAXIAL DRIVER

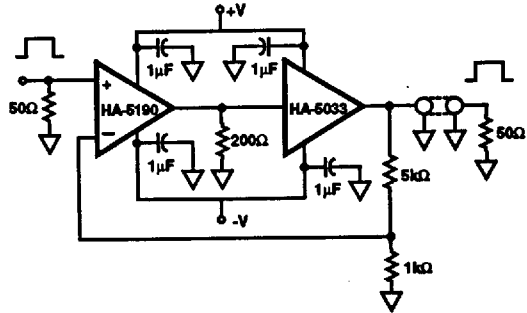

FIGURE 17. VIDEO PULSE AMPLIFIER COAXIAL LINE DRIVER