

## 5 channels step-up white LED driver

Datasheet – production data

### Features

- Operating input voltage range from 2.3 V to 5.5 V
- $\pm 7.5\%$  LED current accuracy
- Two LEDs in series per channel
- High side current source
- Up to 125 mA of total LED current
- 86% efficiency at 100 mA
- PWM dimming with automatic shutdown time window
- 2.5 MHz switching frequency
- CSP 12 bumps 0.4 mm. pitch 1.4 x 1.8 mm.

### Applications

- LCD backlight with up to 10 LEDs
- Cellular phones
- PDAs

### Description

The STLED25 is a fixed frequency, high efficiency, boost DC-DC converter with five parallel high side current sources. It is capable of providing 125 mA of total current with a maximum voltage of 7.5 V on each channel. Each current source supports single or dual LED connection. The output voltage of the step-up converter is automatically set at 100 mV above the highest voltage required on any driver, to guarantee proper operation of the linear current sources. The device implements a self-test feature to detect failure of any of the LEDs and to disable the related channel. The failure status is reset as soon the IC is disabled. This mode of failure detection allows the device to

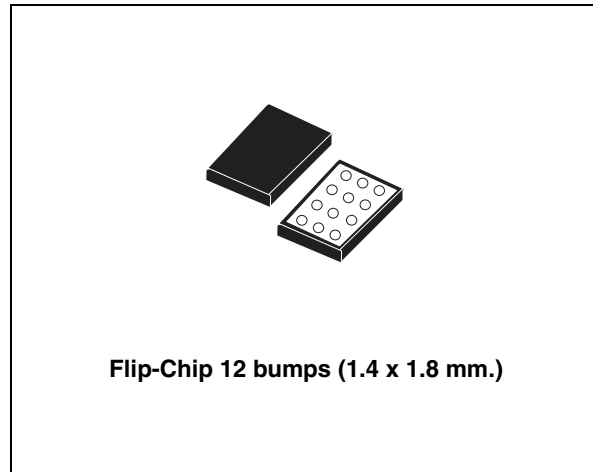

continue operating driver channels that are functioning normally, while avoiding excessive power consumption or associated thermal issues. The control technique is able to maintain the efficiency close to 87% at medium load and higher than 85% at light or full load. The device also includes soft-start control, inrush current limit, thermal shutdown and inductor peak current limit. The STLED25 is packaged in a 12-bump CSP (1.4 x 1.8 mm, 0.5 mm height).

**Table 1. Device summary**

Order code	Package	Packaging
STLED25JR	Flip-Chip12	Tape and reel

# Contents

<b>1</b>	<b>Application schematic</b>	<b>3</b>
<b>2</b>	<b>Pin configuration</b>	<b>5</b>
<b>3</b>	<b>Maximum ratings</b>	<b>6</b>
<b>4</b>	<b>Electrical characteristics</b>	<b>7</b>
<b>5</b>	<b>Typical application performance</b>	<b>9</b>
5.1	Quiescent current consumption	9
5.2	Switching frequency	9
5.3	Continuous output current	10
5.4	Efficiency at 100 mA $I_{OUT}$	10
5.5	Efficiency at 75 mA $I_{OUT}$	11
5.6	Efficiency at 50 mA $I_{OUT}$	11
5.7	Absolute channel accuracy	12
5.8	Current matching between LED strings	12
5.9	PWM dimming linearity 0.39 - 10%	13
5.10	PWM dimming linearity 10 - 100%	13
5.11	Inductor peak current	14
5.12	Maximum continuous output current	14
<b>6</b>	<b>Detailed description</b>	<b>16</b>
6.1	Boost DC-DC converter operation	16
6.2	Current setting	16
6.3	EN13 and EN45	16
6.4	Modes of operation	17
6.5	Undervoltage lockout	17
6.6	Overtemperature protection	18
6.7	Open LED protection	18
6.8	Overvoltage protection	18
6.9	Short LED protection	18

---

<b>7</b>	<b>Application information</b> .....	<b>19</b>
7.1	External passive components .....	19
7.1.1	Inductor selection .....	19
7.1.2	Input and output capacitor selection .....	19
7.2	Recommended PCB layout .....	20
<b>8</b>	<b>Package mechanical data</b> .....	<b>24</b>
<b>9</b>	<b>Revision history</b> .....	<b>29</b>

# 1 Application schematic

Figure 1. STLED25 application schematic

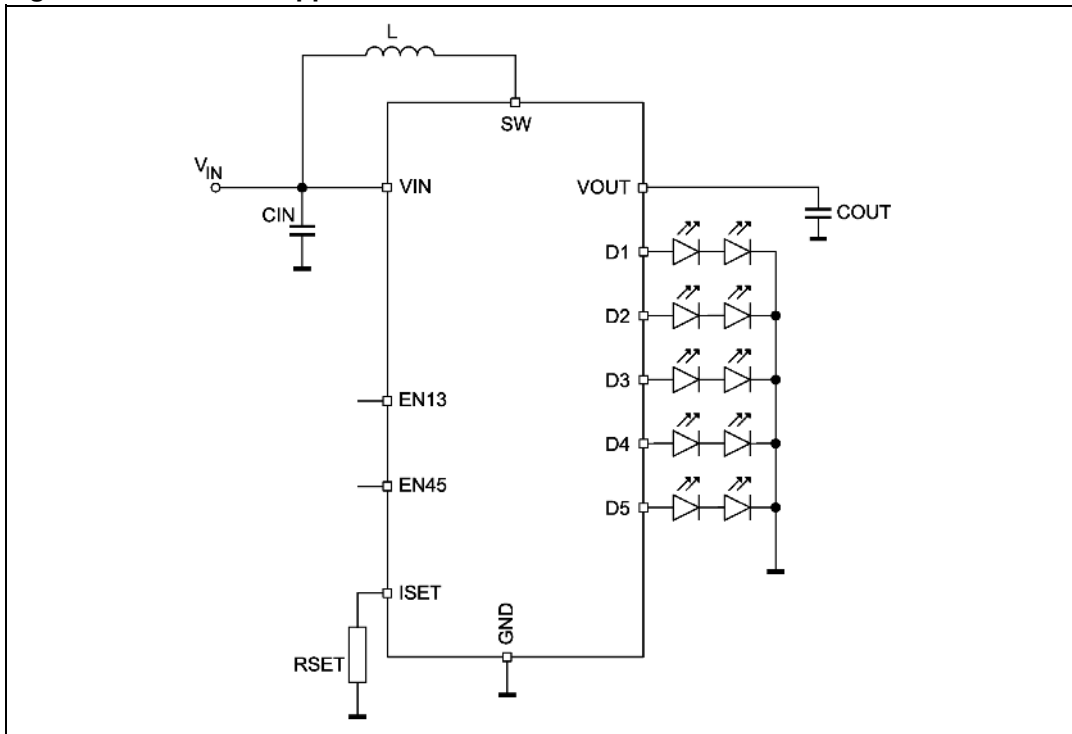

Table 2. Typical external components

Component	Manufacturer	Part number	Value	Size
C <sub>IN</sub>	Murata	GRM155R60J155M	1.5 μF	0402
C <sub>OUT</sub>	Murata	GRM219R61A106ME47	10 μF	0805
L	Samsung	CIG21K4R7SCE	4.7 μH	0805
R <sub>SET</sub>			25 k <sup>(1)</sup>	0402

1. For 20 mA per branch.

*Note:* All the above components refer to a typical application. Operation of the device is not limited to the choice of these external components.

Figure 2. Functional block diagram

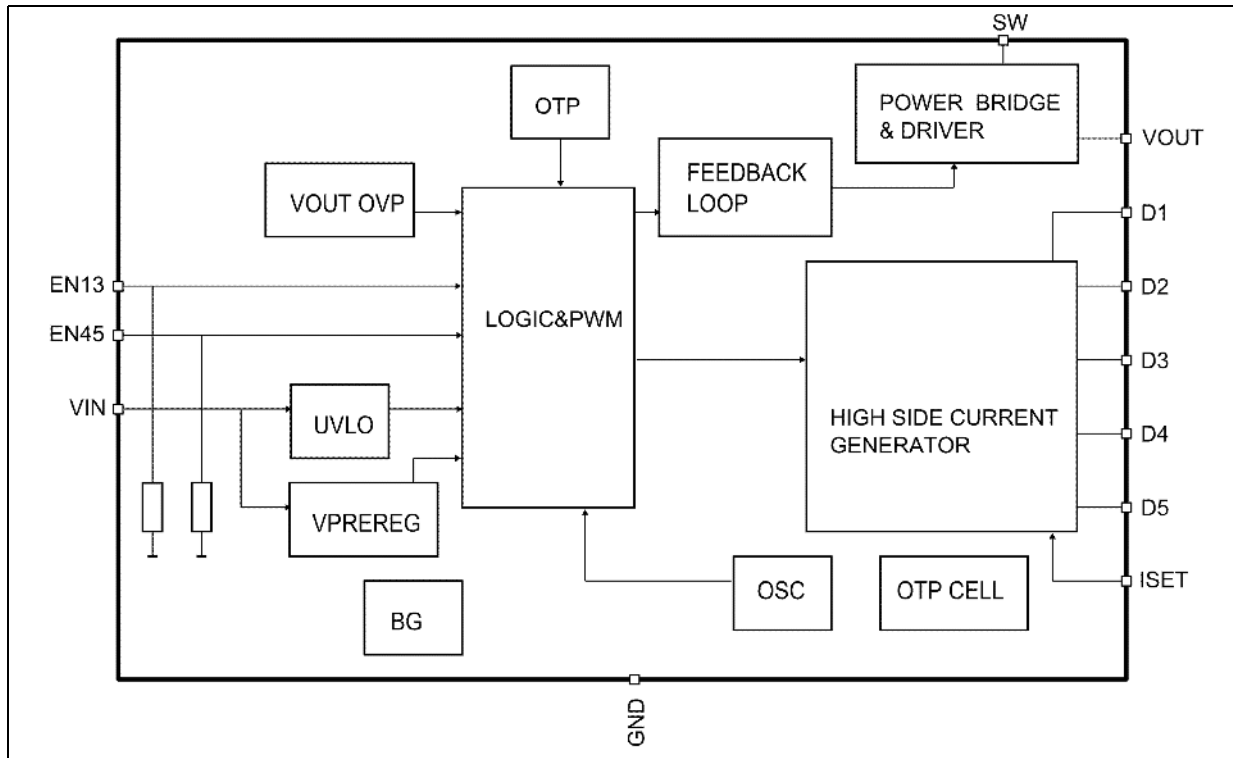

## 2 Pin configuration

Figure 3. Pin configuration (top view)

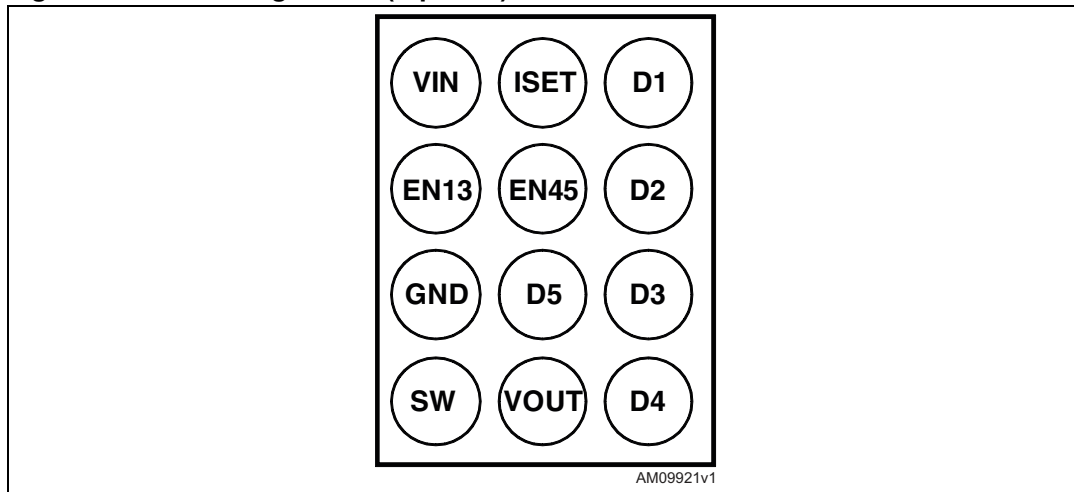

Table 3. Pin description

Pin name	Pin number	Description
VIN	A1	Supply from battery
ISET	A2	Resistor to GND from 1.28 V (typ.) internal reference: 390x current multiplier
D1	A3	String 1 controlled by EN13
EN13	B1	Positive polarity. EN13 & 45 Low = IC shutdown
EN45	B2	Positive polarity. EN13 & EN45 Low = IC shutdown
D2	B3	String 2 controlled by EN13
GND	C1	Power ground and IC ground
D5	C2	String 5 controlled by EN45
D3	C3	String 3 controlled by EN13
SW	D1	Inductor connection to internal switch
VOUT	D2	DC-DC output to V <sub>OUT</sub> capacitor
D4	D3	String 4 controlled by EN45

### 3 Maximum ratings

**Table 4. Absolute maximum ratings**

Symbol	Parameter	Value	Unit
V <sub>IN</sub>	Supply voltage	-0.3 to +6	V
SW	Switching node	-0.3 to + 11	V
V <sub>OUT</sub>	Output voltage	-0.3 to +10	V
D1-D5	LED strings	-0.3 to +10	V
EN13, EN45	Signal pins	-0.3 to V <sub>IN</sub>	V
ISET	Current setting	-0.3 V to 2	V
ESD	Machine model	± 200	V
	Human body model	± 2000	
	Charged device model	± 500	
T <sub>AMB</sub>	Operating ambient temperature	-30 to 85	°C
T <sub>J</sub>	Maximum operating junction temperature	+150	°C
T <sub>STG</sub>	Storage temperature	-65 to 150	°C

**Table 5. Thermal data**

Symbol	Parameter	Value	Unit
R <sub>THJA</sub>	Junction to ambient thermal resistance (1)	62	°C/W

1. This parameter corresponds to a 4-layer PCB board with 1 inch<sup>2</sup> of cooling area.

## 4 Electrical characteristics

- 30 °C < T<sub>A</sub> < 85 °C, V<sub>IN</sub> = 3.7 V; V<sub>OUT</sub> = 7.5 V, EN13 = EN45 = V<sub>IN</sub>, typical values are at T<sub>A</sub> = 25 °C, unless otherwise specified.

**Table 6. Electrical characteristics**

Symbol	Parameter	Test conditions	Min.	Typ.	Max.	Unit
<b>General section</b>						
V <sub>IN</sub>	Operating input voltage		2.3	3.7	5.5	V
I <sub>q</sub>	Shutdown mode	EN13 = EN45 = 0		0.5	2	µA
V <sub>UVLO</sub>	Undervoltage lockout threshold	V <sub>IN</sub> rising		1.9	2.0	V
		V <sub>IN</sub> falling	1.7	1.8		
f <sub>SW</sub>	Switching frequency		2.25	2.5	2.75	MHz
I <sub>OUT</sub>	Continuous output current <sup>(1)</sup>	V <sub>IN</sub> = 2.5 V, V <sub>OUT</sub> = 6.2 V			125	mA
I <sub>PK</sub>	Inductor peak current		550		650	mA
η	Application efficiency <sup>(1)</sup> (V <sub>IN</sub> = 3.7 V; V <sub>OUT</sub> = 6.2 V; see application schematic)	I <sub>OUT</sub> = 50 mA		84		%
		I <sub>OUT</sub> = 75 mA		86		
		I <sub>OUT</sub> = 100 mA		86		
η <sub>DC-DC</sub>	DC-DC converter efficiency	I <sub>OUT</sub> = 100 mA		88		
V <sub>OVP</sub>	Overvoltage protection		8.8	9.05	9.3	V
OVP <sub>HYST</sub>	Overvoltage protection hysteresis			250		mV
T <sub>SHDN</sub>	Thermal shutdown			150		°C
	Hysteresis			20		°C
<b>LEDs current</b>						
I <sub>D1-D5</sub>	Current matching		-5.5		+5.5	%
V <sub>SCP</sub>	Short-circuit protection on LEDs	Measured on the Dx pins		1.28		V
I <sub>LED</sub>	Absolute channel accuracy	5 mA < I <sub>LED</sub> < 25 mA, V <sub>IN</sub> = 2.5 V to 5.5 V	-7.5		+7.5	%
		2.5 mA < I <sub>LED</sub> < 5 mA, V <sub>IN</sub> = 2.5 V to 5.5 V	-10		10	%
I <sub>SET</sub>	Voltage reference	R <sub>SET</sub> = 200 k to 15 k		1.28		V
	Current mirror	I <sub>LED</sub> / I <sub>SET</sub>		390		A/A
V <sub>CSH</sub>	Current source headroom voltage			135		mV



Table 6. Electrical characteristics (continued)

Symbol	Parameter	Test conditions	Min.	Typ.	Max.	Unit
$I_{\text{RIPPLE}}$	LED peak-to-peak current ripple <sup>(1)</sup> <sup>(2)</sup>	$V_{\text{IN}} = 2.5 \text{ V}$ ; $I_{\text{LED}} = 20 \text{ mA}$ at all channels, $\text{EN13}_{\text{PWM}} = \text{EN45}_{\text{PWM}}$		500		$\mu\text{A}$
		$V_{\text{IN}} = 2.5 \text{ V}$ ; $I_{\text{LED}} = 20 \text{ mA}$ at all channels, $\text{EN13}_{\text{PWM}} = \text{EN45}_{\text{PWM}}$		4000		
$\text{PWM}_{\text{LIN}}$	PWM linearity <sup>(1)</sup> <sup>(2)</sup>	1/255 PWM, 300 Hz, 20 mA on all drivers, $V_{\text{IN}} = 2.5 \text{ V}$ <sup>(3)</sup>			10	%
		25/255 PWM, 300 Hz, 20 mA on all drivers, $V_{\text{IN}} = 2.5 \text{ V}$ <sup>(3)</sup>			2	%
$I_{\text{LED\_LEAK}}$	LED driver leakage in OFF state	$V_{\text{OUT}} = 7.5 \text{ V}$			0.5	$\mu\text{A}$
$I_{\text{LED\_MAX}}$	LED driver max current		25			mA
Line_tr	Line transient response <sup>(1)</sup>	$V_{\text{IN\_TR}} = \pm 350 \text{ mV}$ , 10 $\mu\text{s}$ step		30		%
$f_{\text{DIM}}$	PWM dimming frequency		100		800	Hz
$D_{\text{DIM}}$	Duty cycle of PWM dimming		0.39		100	%
<b>Logic inputs</b>						
$R_{\text{EN}}$	Internal pull-down resistor			100		k $\Omega$
$V_{\text{IL}}$	EN low-level input voltage	$V_{\text{IN}} = 2.7 \text{ V}$ to 4.5 V			0.68	V
		$V_{\text{IN}} = 2.3 \text{ V}$ to 5.5 V			0.55	
$V_{\text{IH}}$	EN high-level input voltage	$V_{\text{IN}} = 2.7 \text{ V}$ to 4.5 V	1.07			V
		$V_{\text{IN}} = 2.3 \text{ V}$ to 5.5 V	1.14			
$I_{\text{LK-I}}$	EN input leakage current	$V_{\text{EN}} = V_{\text{IN}} = 4.2 \text{ V}$ , 100 k internal pulldowns		42		$\mu\text{A}$
<b>Power switches</b>						
$R_{\text{DSON}}$	P-channel on resistance			880		m $\Omega$
	N-channel on resistance			450		
$I_{\text{LKG-LX}}$	LX leakage current	$V_{\text{IN}} = V_{\text{LX}} = 4.8 \text{ V}$ ; $V_{\text{EN}} = 0$			1	$\mu\text{A}$

1. Not tested in production

2. 10% value reduction at  $V_{\text{IN}} = 2.3 \text{ V}$

3. The PWM linearity is measured on the mean value of the output current in PWM mode in the 100 ms window. The frequency of the PWM is 300 Hz

## 5 Typical application performance

### 5.1 Quiescent current consumption

Figure 4. Quiescent current at different ambient temperatures

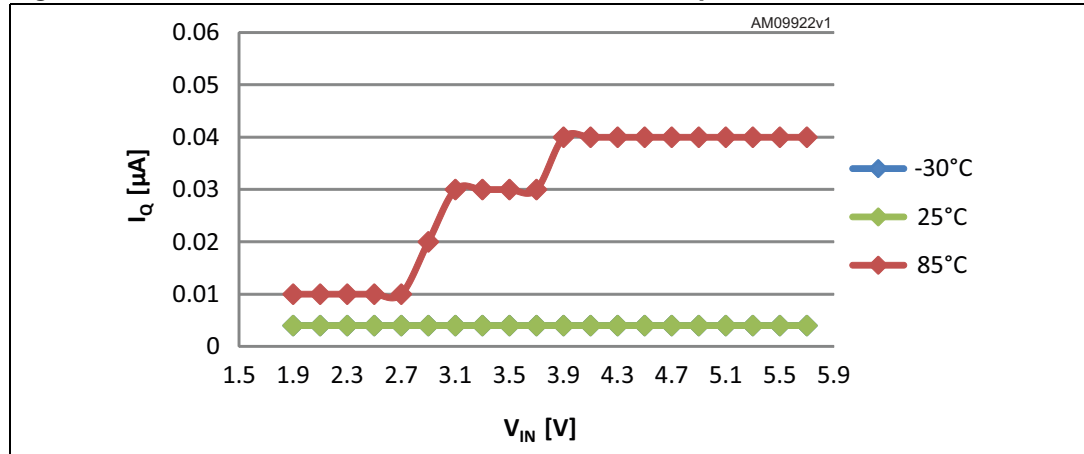

### 5.2 Switching frequency

Figure 5. Switching frequency at different ambient temperatures

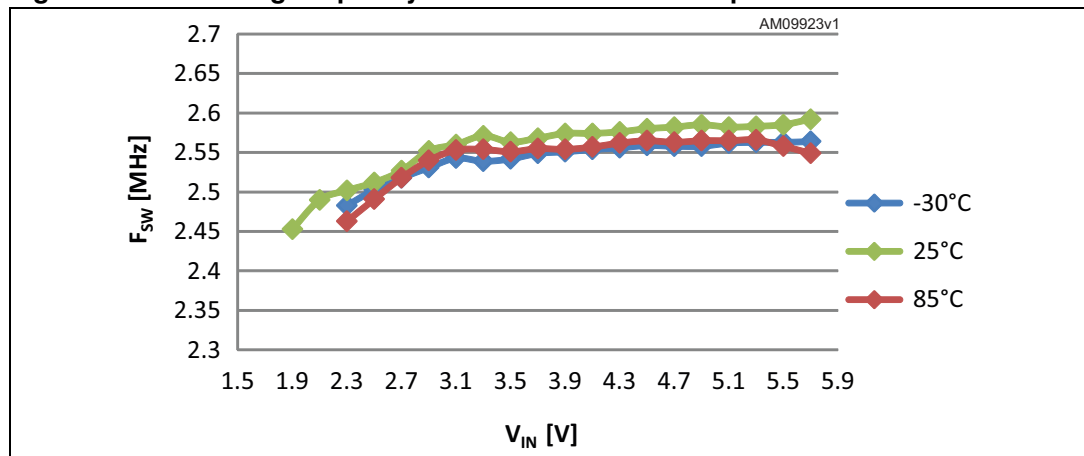

### 5.3 Continuous output current

Figure 6. Output current when  $V_{OUT} = 8.5\text{ V}$  at different ambient temperatures

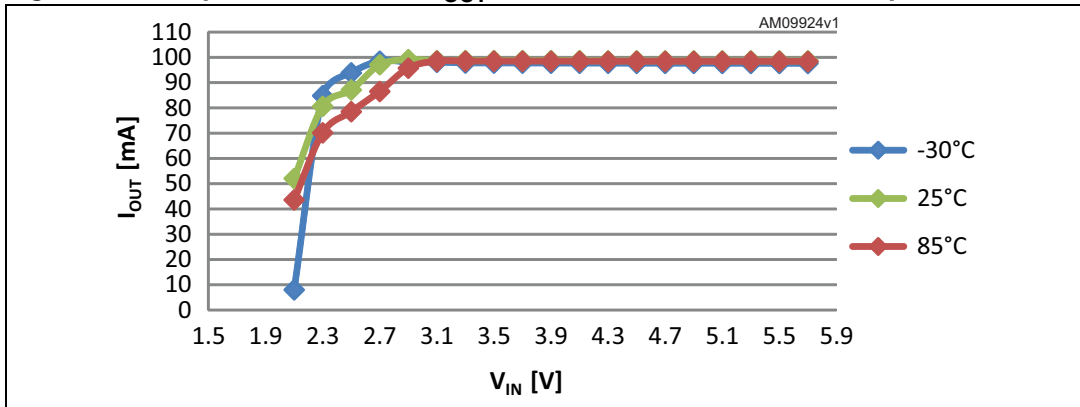

### 5.4 Efficiency at 100 mA $I_{OUT}$

Figure 7. Efficiency when  $I_{OUT} = 100\text{ mA}$  at different ambient temperatures

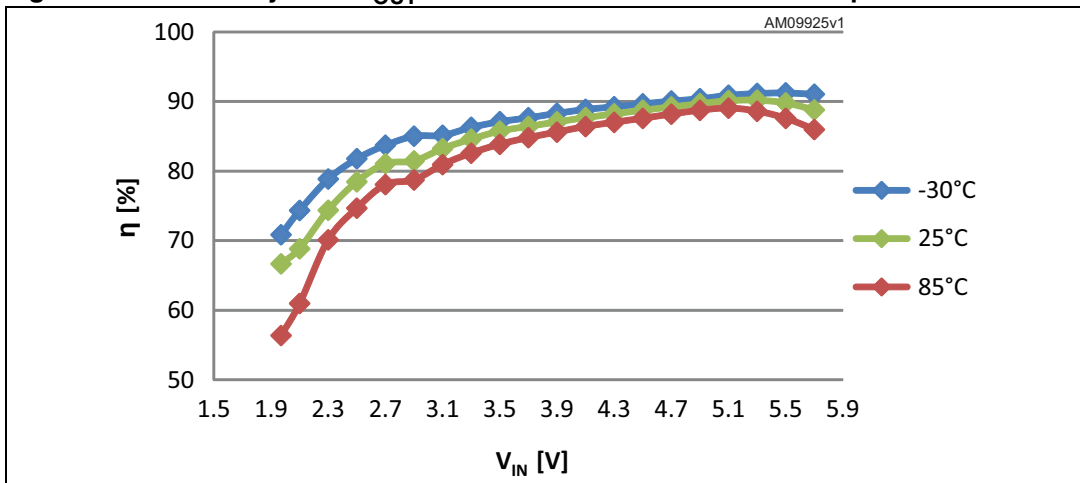

### 5.5 Efficiency at 75 mA I<sub>OUT</sub>

Figure 8. APPL efficiency when I<sub>OUT</sub> = 75 mA at T<sub>A</sub> = 25 °C

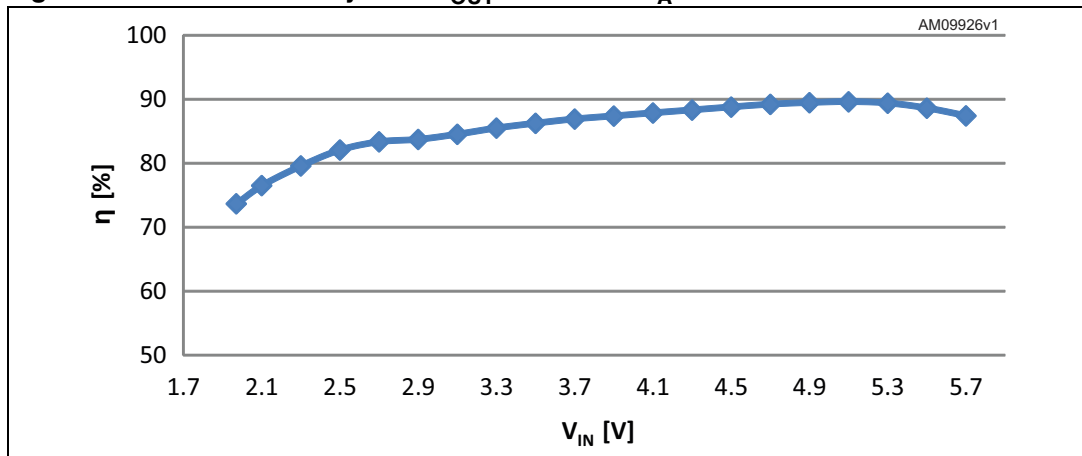

### 5.6 Efficiency at 50 mA I<sub>OUT</sub>

Figure 9. APPL efficiency when I<sub>OUT</sub> = 50 mA at T<sub>A</sub> = 25 °C

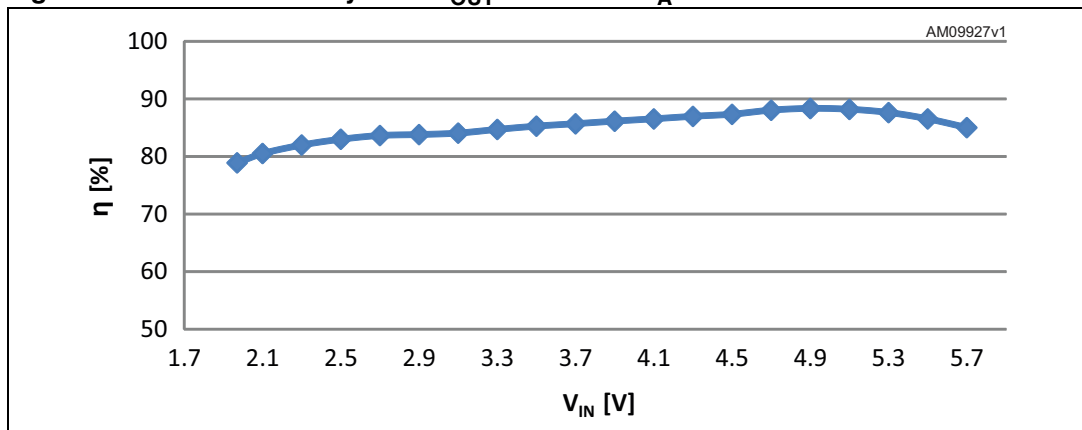

### 5.7 Absolute channel accuracy

Figure 10. Absolute channel accuracy - set string current to 20 mA

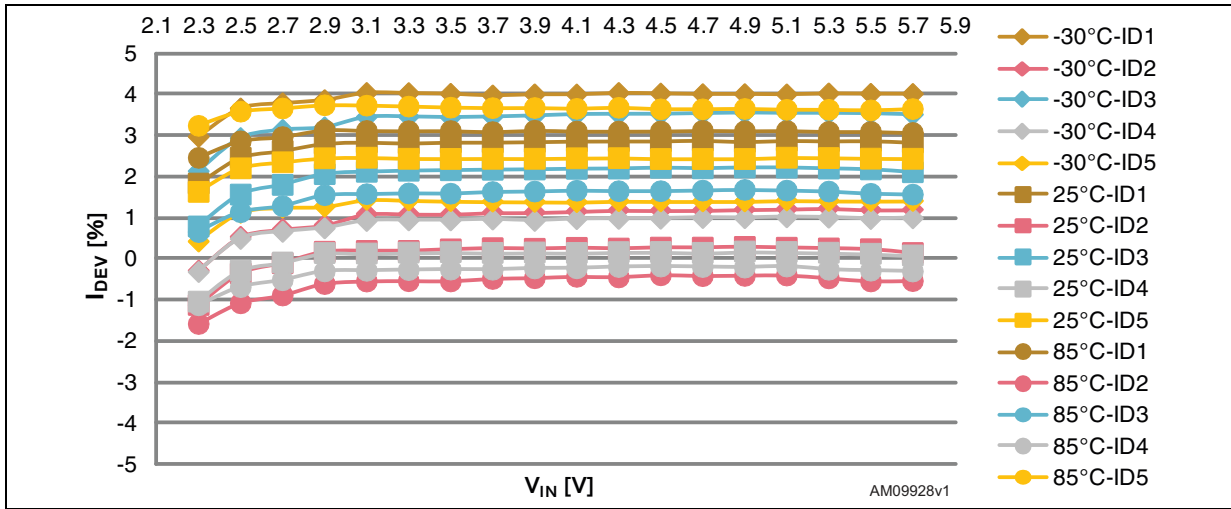

### 5.8 Current matching between LED strings

Figure 11. Current matching - set string current to 20 mA

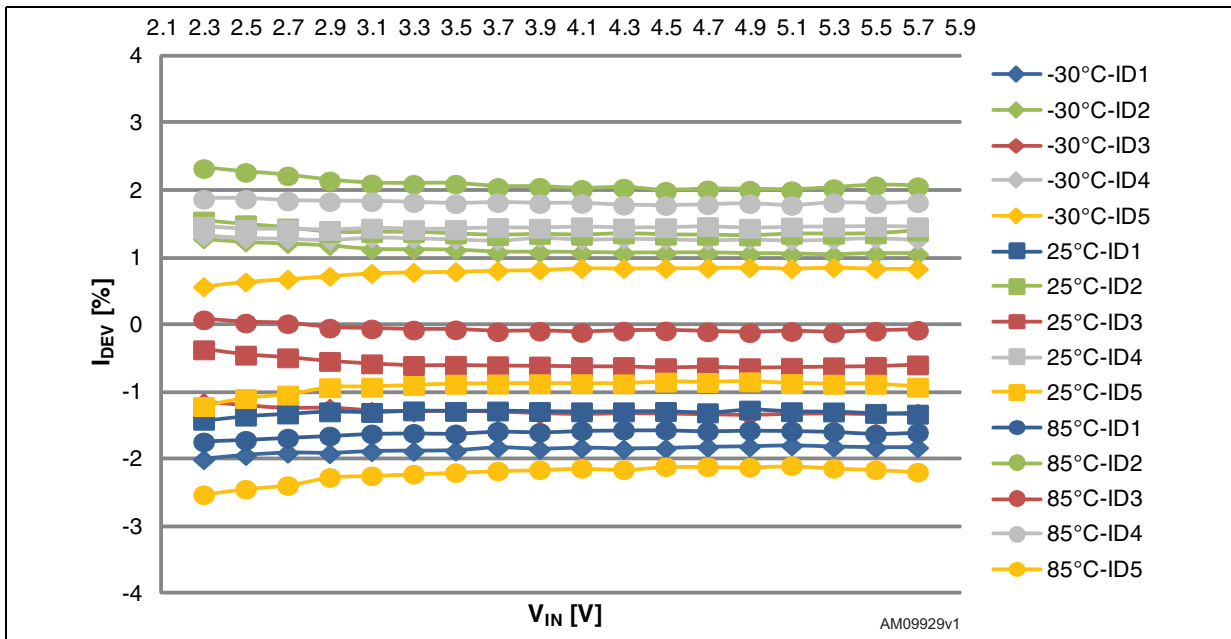

### 5.9 PWM dimming linearity 0.39 - 10%

Figure 12. PWM linearity 0.39 - 10% at  $T_A = 25\text{ }^\circ\text{C}$

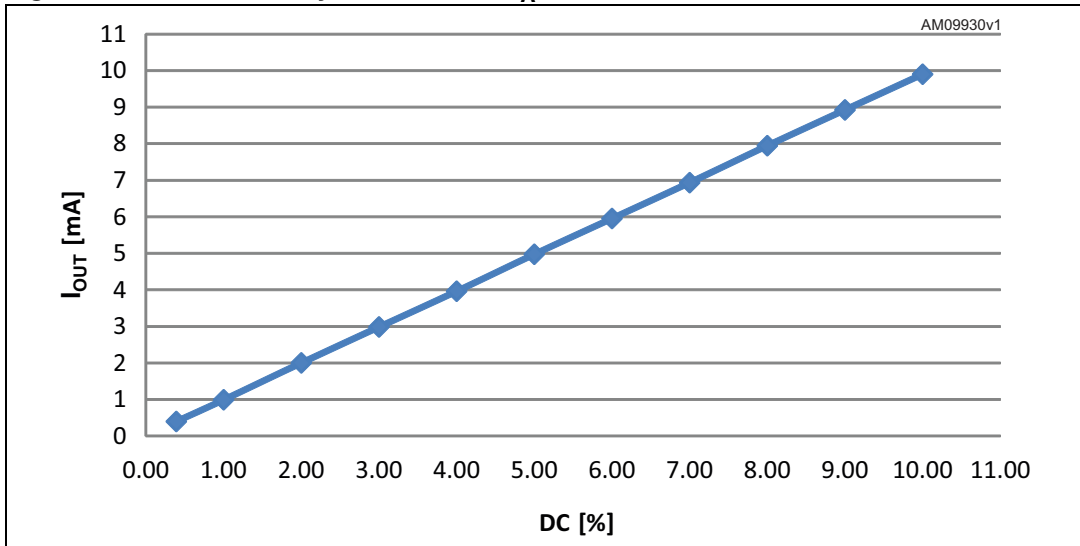

### 5.10 PWM dimming linearity 10 - 100%

Figure 13. PWM linearity 10 - 100% at  $T_A = 25\text{ }^\circ\text{C}$

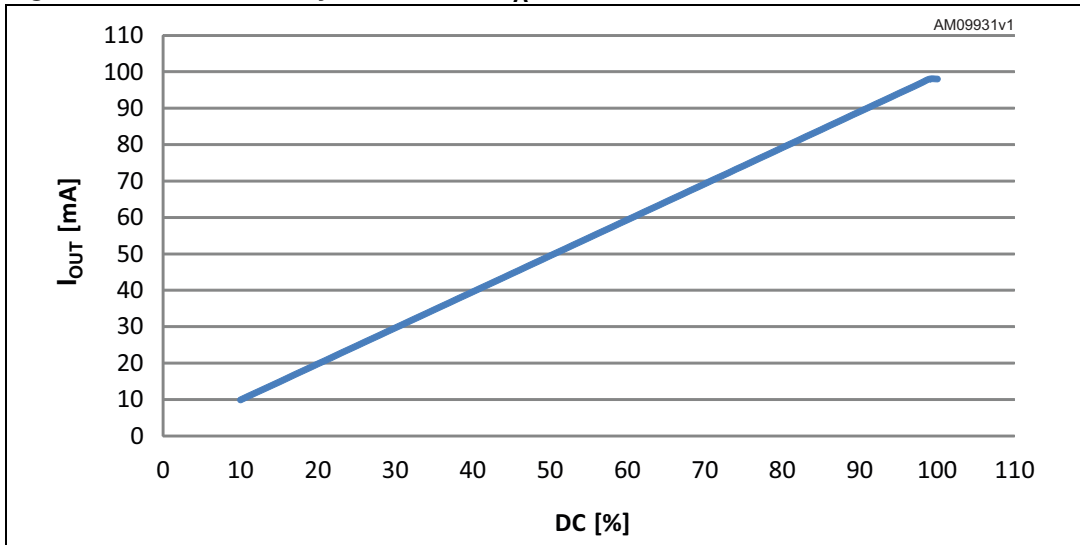

### 5.11 Inductor peak current

Figure 14. Inductor peak current at  $T_A = 25\text{ }^\circ\text{C}$

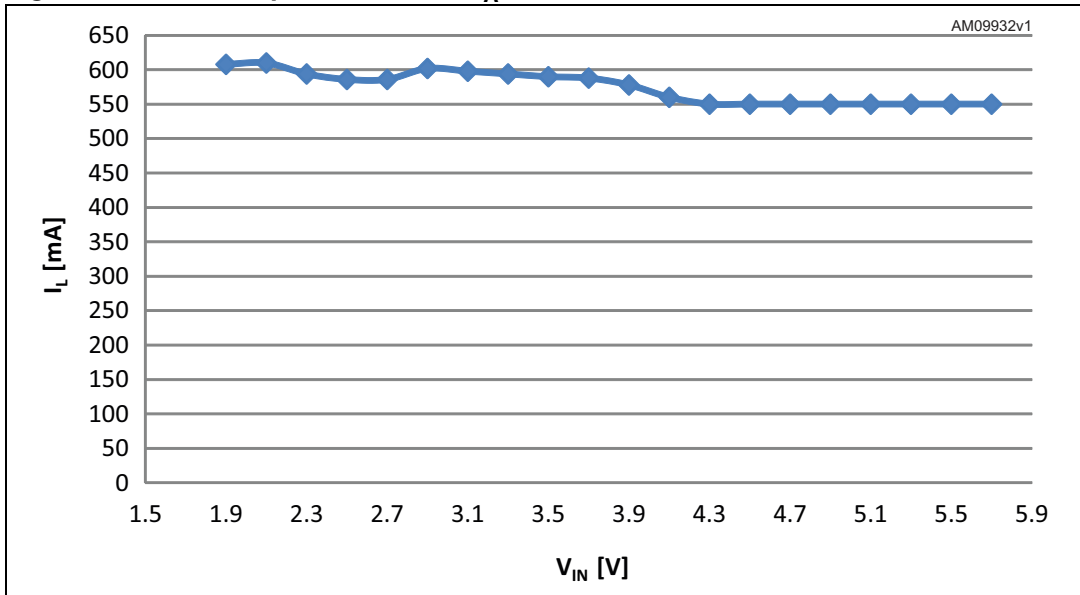

### 5.12 Maximum continues output current

Figure 15. Maximum output current at  $T_A = 25\text{ }^\circ\text{C}$

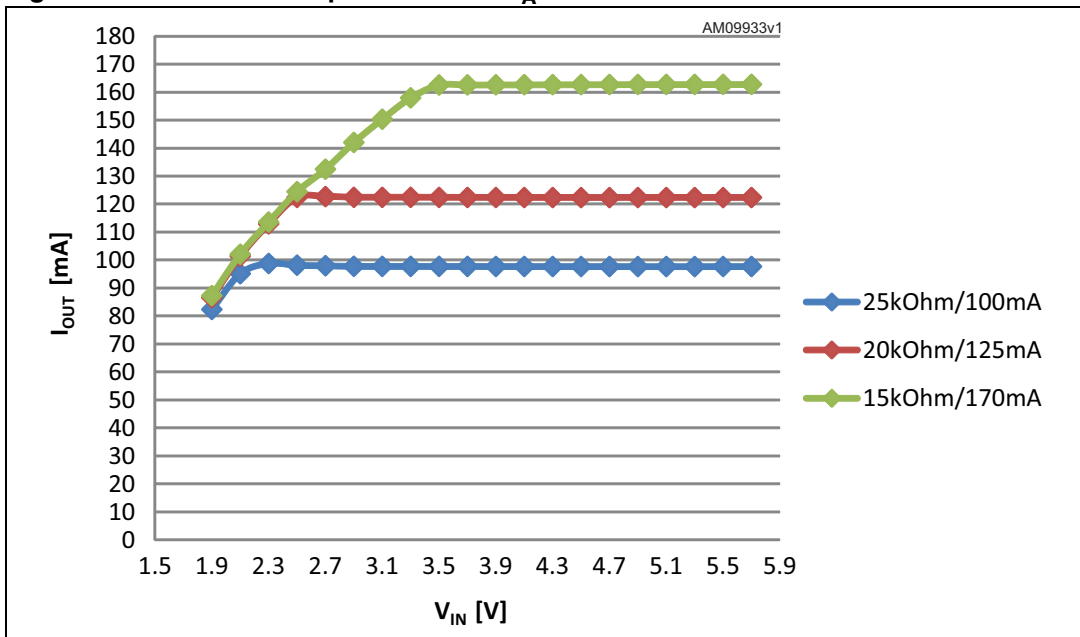

Figure 16. Startup waveform



Figure 17. Line transient response

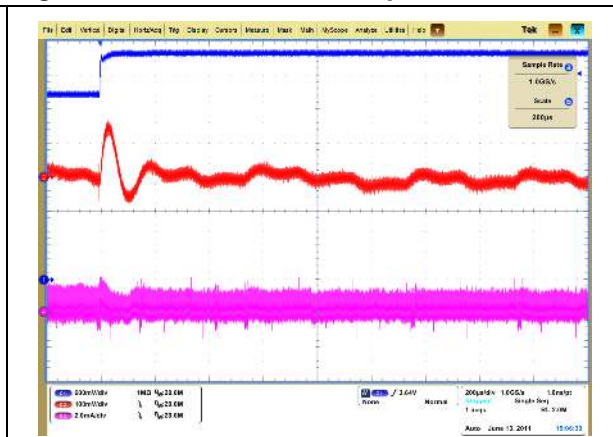
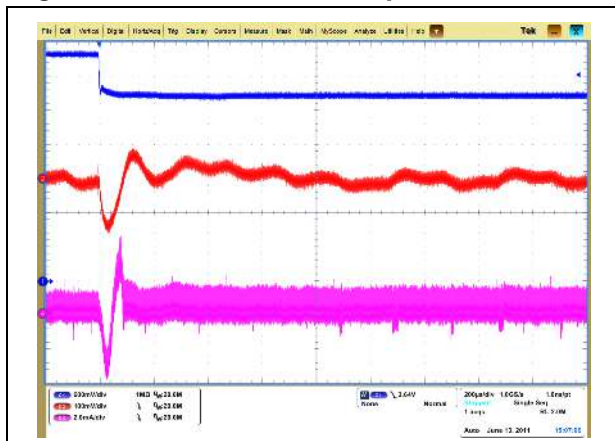

Figure 18. Line transient response





## 6 Detailed description

The STLED25 is a high efficiency white LED power supply which integrates a step-up converter and 5 high-side current sources. The device is controlled by two enable inputs called EN13 and EN45 according to the labels of the LED channels. EN13 enables LED channels 1, 2, 3 and EN45 enables LED channels 4, 5. The device is protected against shorted LED channels by short LED protection and against open LED channels by open LED protection. The device is able to recognize which channel has failed, and switch off this channel to maintain correct operation of the remaining channels. The STLED25 device is 125 mA total output current capable and works over a battery voltage range of 2.3 V to 5.5 V. The typical output voltage during operation corresponds to the voltage level equal to  $V_{FLED} + 125 \text{ mV}$ . The STLED25 device has an optimized switching power bridge to reach a high level of application efficiency (86%) with the typical battery voltage of 3.7 V. The device is also able to work at high efficiency when not all the LED channels of the device are used.

### 6.1 Boost DC-DC converter operation

The step-up bridge with current mode control of the regulation regulates the output voltage level according to the LED channel with the highest  $V_{FLED}$ , in order to maintain sufficient voltage headroom for the related current sources. The typical headroom of the current sources is in the range of 135 mV. The STLED25 contains a current limiter, with a typical value 600 mA, and soft-start control to limit the supply current from the battery. The method of regulation during startup and normal operation is explained in [Section 6.4](#).

### 6.2 Current setting

Each LED channel regulates to the same current. The value of the LED current is set by choosing the  $R_{SET}$  resistor. The current flowing through this resistor is mirrored in order to obtain the LED current. The multiplication factor is 390.

The LED current is calculated with the following formula:

#### Equation 1

$$I_{LED} = \frac{V_{SET}}{R_{SET}} \times 390$$

where:

$V_{SET} = 1.28 \text{ V}$  typical

### 6.3 EN13 and EN45

EN13 and EN45 play the dual role of enable pin and PWM dimming. EN13 drives strings D1, D2, D3 while EN45 drives D4 and D5. Both EN13 and EN45 are pulled down internally by 100 k resistors.

The EN pins accept a signal between 100 Hz and 800 Hz, at duty cycles from 0.39% to 100%. The output average current maximum error is 10% at 0.39%, PWM duty cycle at 300 Hz.

## 6.4 Modes of operation

### Shutdown mode

The device is in shutdown with minimum current consumption. It goes to PWM\_start as soon as EN13 or EN45 are pulled high.

### PWM\_start

Once ENxx is asserted, the DC-DC is turned ON with a soft-start procedure until  $V_{OUT}$  reaches 7 V; this phase takes around 1.2 ms.

If ENxx remains asserted, the device will stay in this condition and wait for 10 ms (PWM\_start\_up), then the STLED25 goes to PWM\_normal mode. If the next EN is asserted during the PWM\_start\_up mode, the device will immediately enable the LED current sources and continue in PWM\_normal mode.

### PWM\_normal

In this mode of operation the drivers are in the ON state delivering current to the LEDs, and the DC-DC converter maintains the  $V_{OUT}$  value with enough headroom to keep the high side current sources in regulation.

When both EN pins are low, the drivers are turned off and the RUN\_HOLD timer starts.

### RUN\_hold

The RUN\_hold time lasts approximately 30 ms. During this time, the DC-DC converter maintains the last optimum voltage on  $V_{OUT}$ . If RUN\_hold time elapses without EN reassertion, then the STLED25 goes into shutdown mode. If EN is reasserted, the device goes to PWM\_normal mode.

Figure 19. Modes of operation

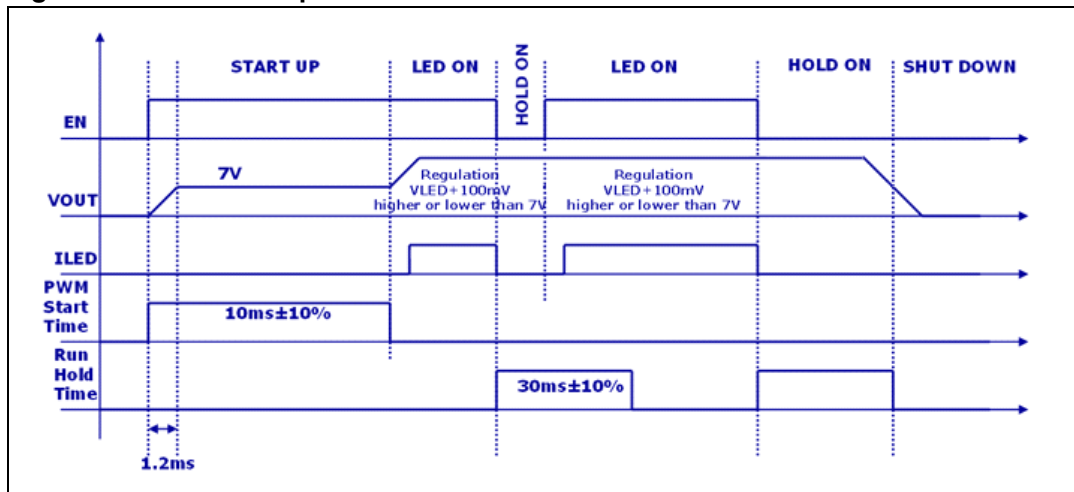

## 6.5 Undervoltage lockout

The undervoltage lockout function prevents improper operation of the STLED25 when the input voltage is not high enough. When the input voltage is below the UVLO threshold, the device is in shutdown mode. The hysteresis of 100 mV prevents unstable operation when the input voltage is close to the UVLO threshold.

## 6.6 Overtemperature protection

An internal temperature sensor continuously monitors the IC junction temperature. If the IC temperature exceeds 150 °C (typical), the device stops operating. As soon as the temperature falls below 135 °C (typical), normal operation is restored.

## 6.7 Open LED protection

The device is able to detect an “Open LED” failure in each LED channel independently. When this failure appears, the DC-DC increases the output voltage to maintain the current source headroom voltage until the OVP threshold is reached; the device detects which LED channel is the root cause and switches off this LED channel. This state is maintained until the STLED25 goes into shutdown mode.

## 6.8 Overvoltage protection

The device has overvoltage protection on the  $V_{OUT}$  pin to protect the device and external components against the high voltage coming from the DC-DC, in case of a disconnected load. When the output voltage level reaches the OVP threshold (9.3 V typical), the DC-DC is turned off until the output voltage level goes below the OVP threshold. The hysteresis of the OVP threshold is approximately 250 mV.

## 6.9 Short LED protection

The device is able to detect a shorted LED in each LED channel independently; when the protection detects a failure on any of the LED channels, it switches off this channel until the STLED25 enters shutdown mode.

## 7 Application information

### 7.1 External passive components

#### 7.1.1 Inductor selection

The inductor is the key passive component for switching converters.

For the STLED25, an inductance of 4.7 μH is recommended. It is very important to select the right inductor according to the maximum current the inductor can handle to avoid saturation. The peak current for the step-up can be calculated with the following formula:

**Equation 2**

$$I_{PEAK-BOOST} = \frac{V_{OUT} \times I_{OUT}}{\eta \times V_{IN_{MIN}}} + \frac{V_{IN_{MIN}} \times (V_{OUT} - V_{IN_{MIN}})}{2 \times V_{OUT} \times f_s \times L}$$

where:

V<sub>OUT</sub>: step-up output voltage. The boost control loop keeps it 135 mV higher than the maximum among VD1-D5

I<sub>OUT</sub>: total output current

V<sub>IN</sub>: input voltage of STLED25

f<sub>s</sub>: switching frequency. Use the minimum value of 2.25 MHz for the worst case

η: efficiency of step-up converter. It is 0.87 at 75 mA load

**Table 7. List of recommended inductors**

Manufacturer	Part number	Inductance [μH]	Saturation current [A]	Size [mm]
Samsung	CIG21K4R7SCE	4.7	0.6	0805
Murata	LQM21PN4R7	4.7	0.6	0805

#### 7.1.2 Input and output capacitor selection

It is recommended to use ceramic capacitors with low ESR as input and output capacitors in order to filter any disturbance present in the input line and to maintain stable operation of the step-up converter. A minimum real capacitance value of 1 μF must be guaranteed for C<sub>IN</sub> and 4.2 μF C<sub>OUT</sub> in all conditions.

Table 8. Input and output capacitor

Manufacturer	Part number	Nominal capacitance [ $\mu\text{F}$ ]	Rated voltage [V]	TCC	Size [mm]
<b>C<sub>IN</sub></b>					
Murata	GRM155R60J155M	1.5	6.3		0402
Samsung	CL05A225MQ5NSKC	2.2	6.3		0402
<b>C<sub>OUT</sub></b>					
Murata	GRM219R61A106ME47	10	10		0805

## 7.2 Recommended PCB layout

The STLED25 is a high-frequency power switching device, so it requires a proper PCB layout in order to obtain the necessary stability and optimize line/load regulation and output voltage ripple. Input and output capacitors must be as close as possible to their relative pins.

Figure 20. Top layer

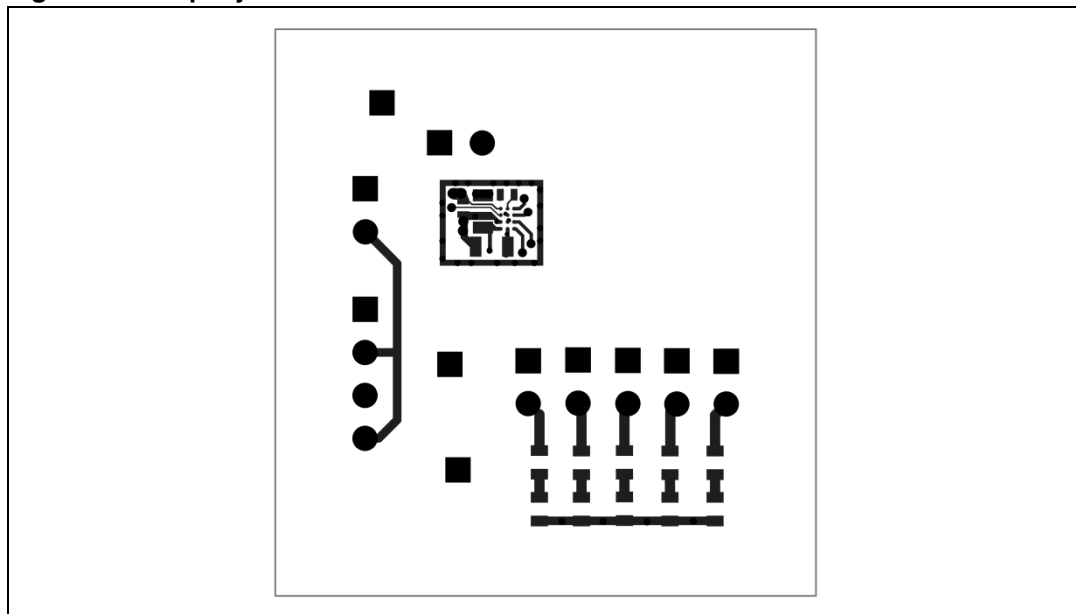

Figure 21. Mid layer 1

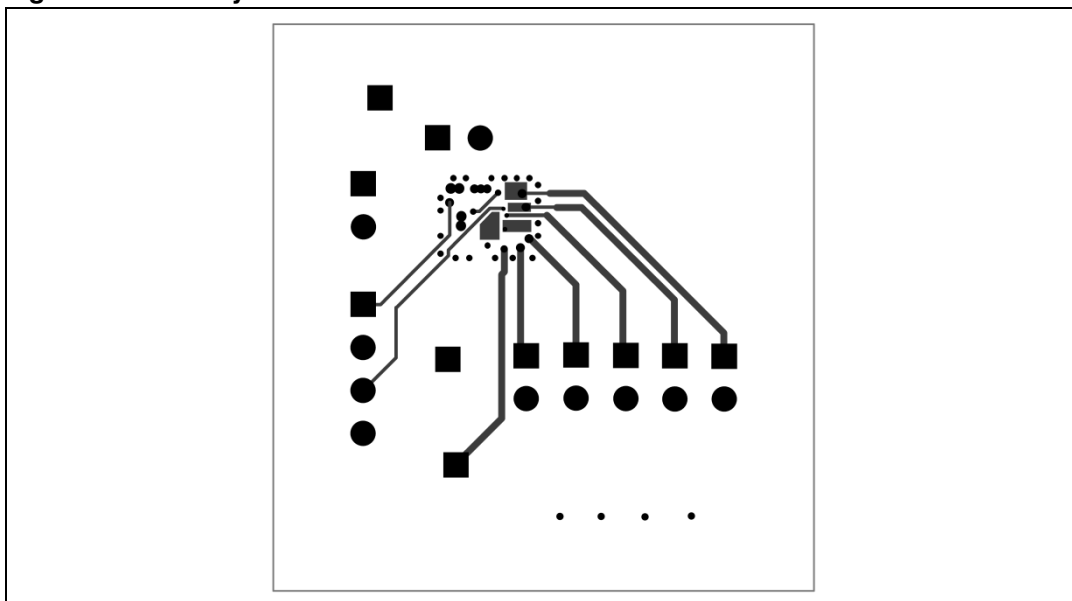

Figure 22. Mid layer 2

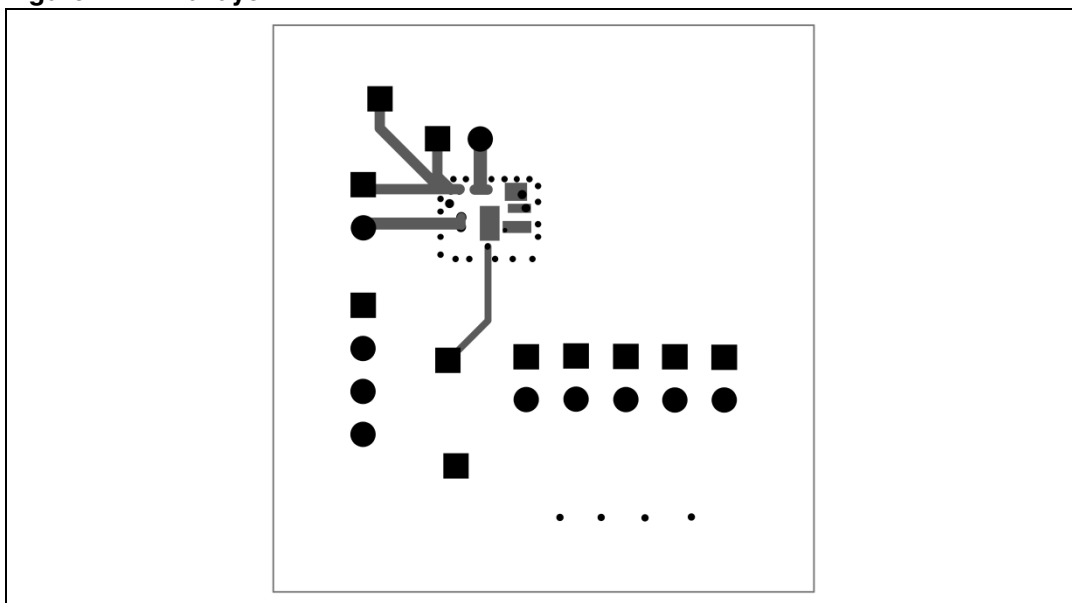

Figure 23. Bottom layer

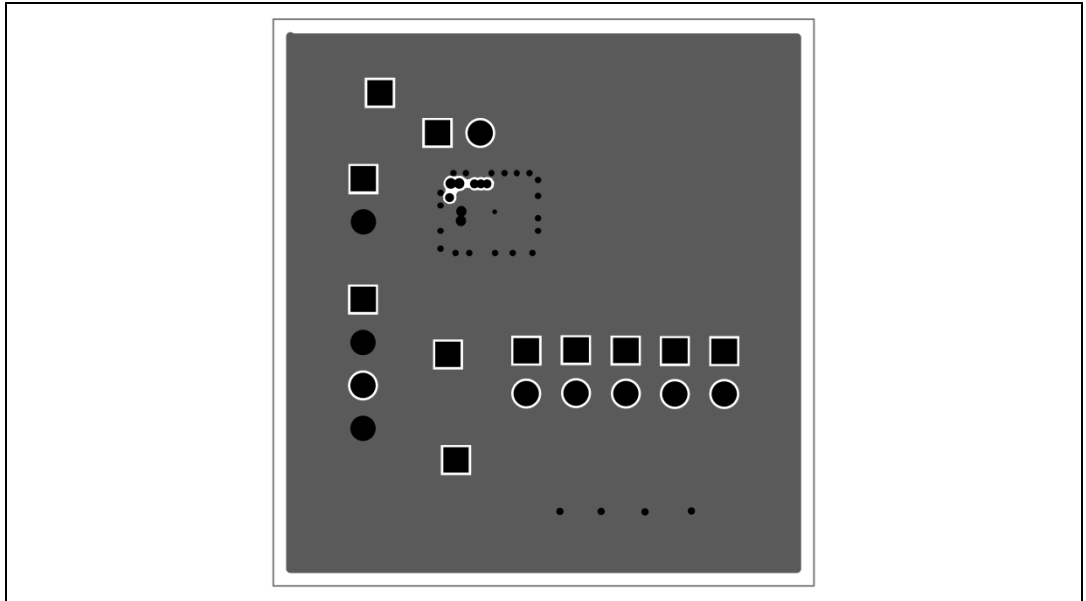

Figure 24. Top overlay

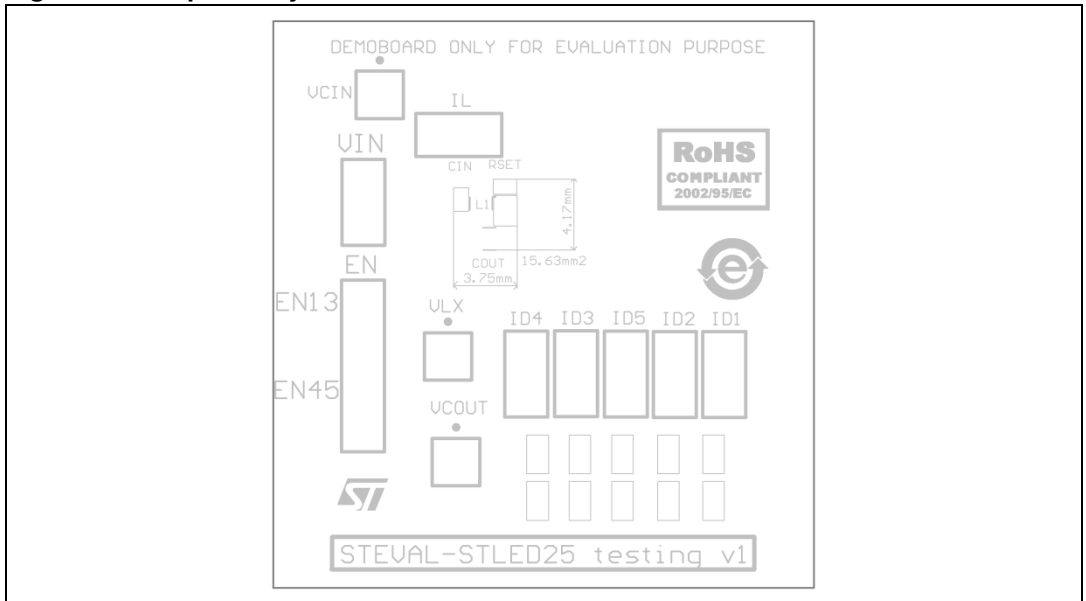
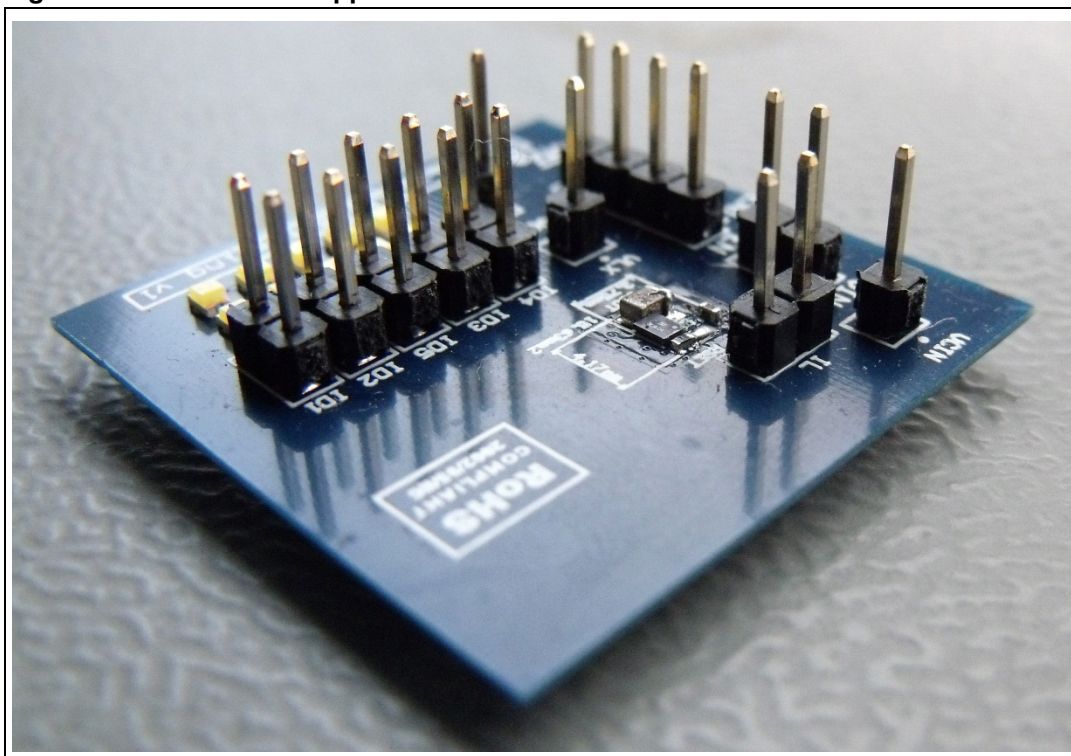

Figure 25. Photo of the application board





## 8 Package mechanical data

In order to meet environmental requirements, ST offers these devices in different grades of ECOPACK<sup>®</sup> packages, depending on their level of environmental compliance. ECOPACK<sup>®</sup> specifications, grade definitions and product status are available at: [www.st.com](http://www.st.com). ECOPACK<sup>®</sup> is an ST trademark.

**Flip-chip 12 mechanical data**

Dim.	mm.		
	Min.	Typ.	Max.
A	0.45	0.50	0.55
A1	0.17	0.20	0.23
A2	0.28	0.30	0.32
b	0.22	0.26	0.30
D	1.815	1.845	1.875
D1		1.20	
E	1.358	1.388	1.418
E1		0.80	
e	0.36	0.40	0.44
fD	0.313	0.323	0.333
fE	0.284	0.294	0.304
ccc			0.05

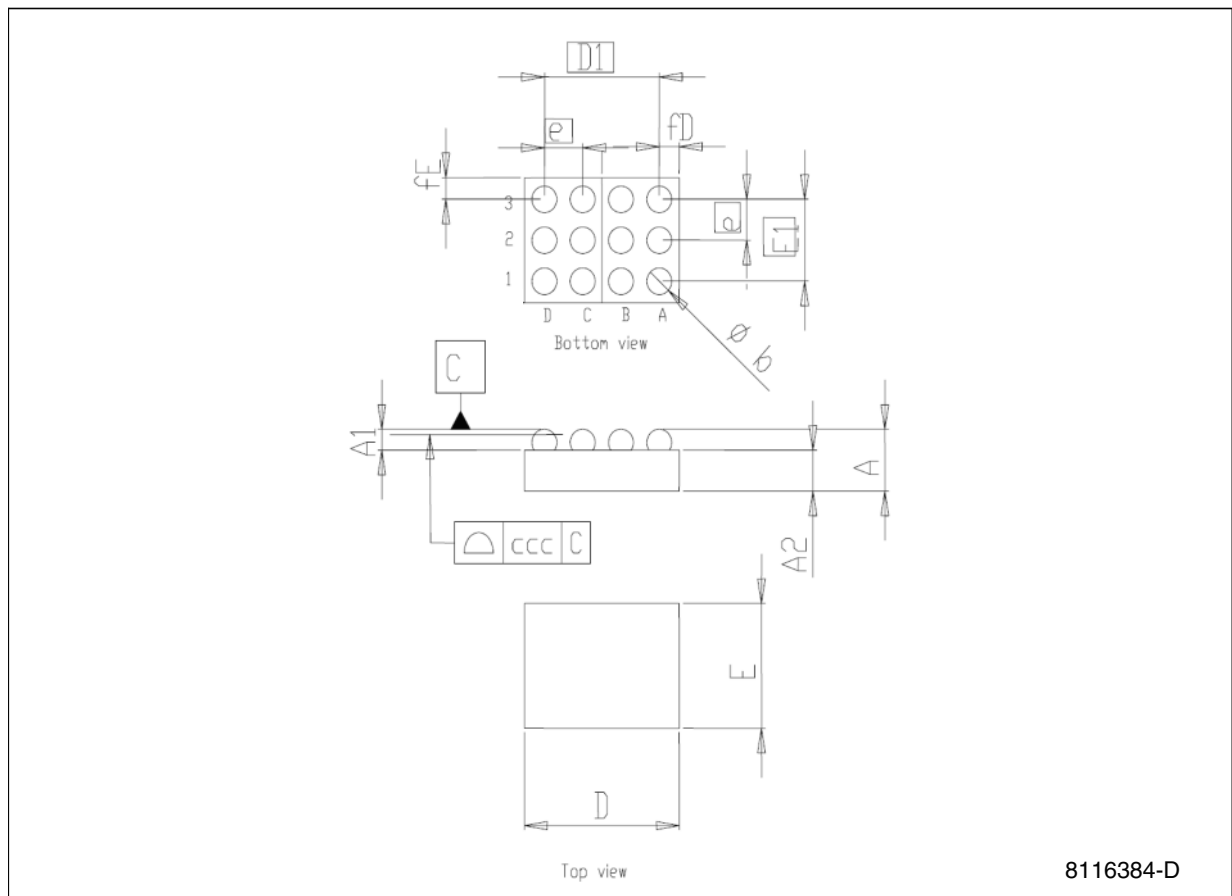

**Tape & reel Flip-Chip 12 mechanical data**

Dim.	mm.			inch.		
	Min.	Typ.	Max.	Min.	Typ.	Max.
A			180			7.087
C	12.8		13.2	0.504		0.520
D	20.2			0.795		
N	60			2.362		
T			14.4			0.567
Ao	1.46	1.51	1.56	0.057	0.059	0.061
Bo	1.89	1.94	1.99	0.074	0.076	0.078
Ko	0.54	0.59	0.64	0.021	0.023	0.025
Po	3.9		4.1	0.154		0.161
P	3.9		4.1	0.154		0.161

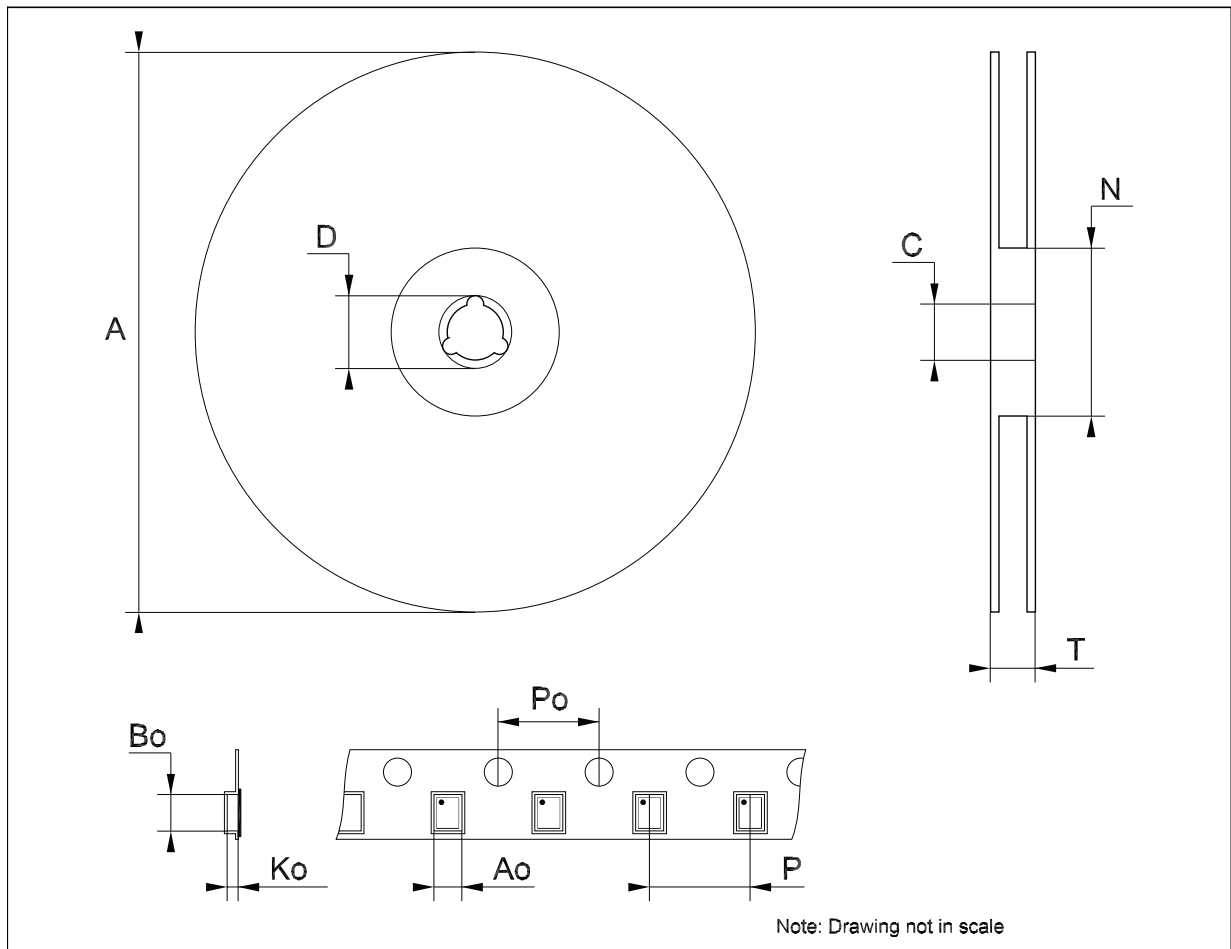
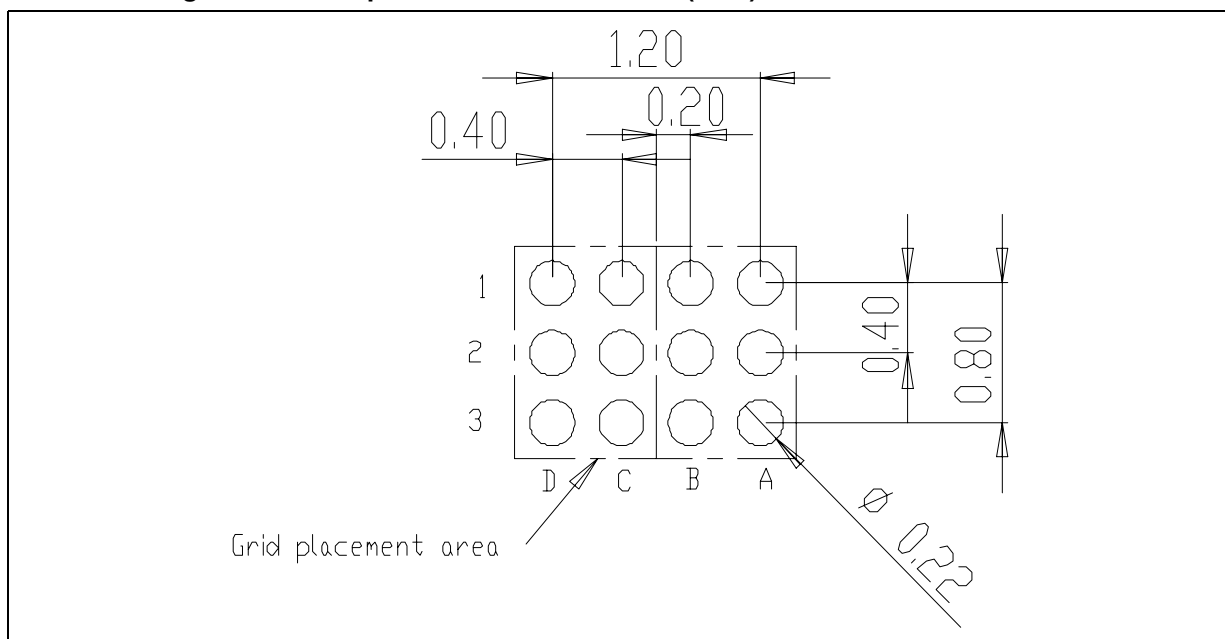

Figure 26. Footprint recommended data (mm.)



## 9 Revision history

**Table 9. Document revision history**

Date	Revision	Changes
10-Oct-2011	1	Initial release.
13-Dec-2011	2	Modified: C <sub>OUT</sub> part number <a href="#">Table 2 on page 4</a> and <a href="#">Table 8 on page 21</a> .
11-May-2012	3	Document status promoted from preliminary data to production data.

**Please Read Carefully:**

Information in this document is provided solely in connection with ST products. STMicroelectronics NV and its subsidiaries ("ST") reserve the right to make changes, corrections, modifications or improvements, to this document, and the products and services described herein at any time, without notice.

All ST products are sold pursuant to ST's terms and conditions of sale.

Purchasers are solely responsible for the choice, selection and use of the ST products and services described herein, and ST assumes no liability whatsoever relating to the choice, selection or use of the ST products and services described herein.

No license, express or implied, by estoppel or otherwise, to any intellectual property rights is granted under this document. If any part of this document refers to any third party products or services it shall not be deemed a license grant by ST for the use of such third party products or services, or any intellectual property contained therein or considered as a warranty covering the use in any manner whatsoever of such third party products or services or any intellectual property contained therein.

**UNLESS OTHERWISE SET FORTH IN ST'S TERMS AND CONDITIONS OF SALE ST DISCLAIMS ANY EXPRESS OR IMPLIED WARRANTY WITH RESPECT TO THE USE AND/OR SALE OF ST PRODUCTS INCLUDING WITHOUT LIMITATION IMPLIED WARRANTIES OF MERCHANTABILITY, FITNESS FOR A PARTICULAR PURPOSE (AND THEIR EQUIVALENTS UNDER THE LAWS OF ANY JURISDICTION), OR INFRINGEMENT OF ANY PATENT, COPYRIGHT OR OTHER INTELLECTUAL PROPERTY RIGHT.**

**UNLESS EXPRESSLY APPROVED IN WRITING BY TWO AUTHORIZED ST REPRESENTATIVES, ST PRODUCTS ARE NOT RECOMMENDED, AUTHORIZED OR WARRANTED FOR USE IN MILITARY, AIR CRAFT, SPACE, LIFE SAVING, OR LIFE SUSTAINING APPLICATIONS, NOR IN PRODUCTS OR SYSTEMS WHERE FAILURE OR MALFUNCTION MAY RESULT IN PERSONAL INJURY, DEATH, OR SEVERE PROPERTY OR ENVIRONMENTAL DAMAGE. ST PRODUCTS WHICH ARE NOT SPECIFIED AS "AUTOMOTIVE GRADE" MAY ONLY BE USED IN AUTOMOTIVE APPLICATIONS AT USER'S OWN RISK.**

Resale of ST products with provisions different from the statements and/or technical features set forth in this document shall immediately void any warranty granted by ST for the ST product or service described herein and shall not create or extend in any manner whatsoever, any liability of ST.

ST and the ST logo are trademarks or registered trademarks of ST in various countries.

Information in this document supersedes and replaces all information previously supplied.

The ST logo is a registered trademark of STMicroelectronics. All other names are the property of their respective owners.

© 2012 STMicroelectronics - All rights reserved

STMicroelectronics group of companies

Australia - Belgium - Brazil - Canada - China - Czech Republic - Finland - France - Germany - Hong Kong - India - Israel - Italy - Japan - Malaysia - Malta - Morocco - Philippines - Singapore - Spain - Sweden - Switzerland - United Kingdom - United States of America

[www.st.com](http://www.st.com)