

BGN1800

(1.2V 1800mAh)

Rechargeable Sealed Nickel Cadmium Battery Pack



Technical Specification Sheet



This specification governs the performance of the following Nickel-Cadmium Cylindrical cell and its stack-up battery. All data involves voltage and weight to stack-up battery are equal to the value of unit cell times the number of unit cell which consisted in the stack-up batteries.

RATINGS

Description	Unit	Specification	Conditions	
Nominal Voltage	V/Cell	1.2V	Unit cell	
Nominal Voltage	mAh	1800	Standard Charge/Discharge	
Standard Charge	mA	180 (0.1C)	Ambient Temperature: Ta = 20 ± 5°C	
	Hour	16		
Trickle Charge		0.03C ~ 0.05C	Ta = 0 ~ 45°C	
Standard Discharge	mA	360 (0.2C)	Ambient Temperature: Ta = 20 ± 5°C Humidity: Max. 85%	
Discharge Cut-off Voltage	V/Cell	1.0		
Operating Temperature Range	°C	0 ~ 45°C	Humidity: Max. 85%	
Storage Temperature	°C	-20 ~ 35°C	1 Year	Fully charged state, Humidity Max.60%
		0 ~ 60°C	1 Week	Fully charged state, Humidity Max.80%
Typical Weight	g	Approx. 45.0		

PERFORMANCE

Test	Unit	Specification	Other Condition	Remarks
Capacity	mAh	1800	Standard Charge Discharge	Up to 3 cycles are allowed
Open Circuit Voltage (OCV)	V/Cell	≥1.25	Within 1 hour after standard Charge	
Internal Impedance	mΩ/Cell	≤25	Upon fully charge (1 KHz)	
High Rate Discharge (1.0C)	minute	≥48	Standard Charge, 1 hour rest Before Discharge by 1.0C to 1.0 V/cell	Up to 3 cycles are allowed
Overcharge		No leakage nor explosion	0.1C Charge 14 days	
Charge Retention/	mAh	≥1170 (65%)	Standard Charge, Storage: 45°C Ambient Temperature, Standard Discharge	
IEC Cycle Life/	Cycle	≥500	IEC61951-1(2003)7.4.1.1	(See Note)
Leakage Test		No leakage nor deformation	Fully charged at 0.5C for 2.5 hour stand for 14 days.	
Security Test		No explosion, but leakage or deformation is allowed	Charge the cell 0.1C 16hrs, Then ≤100mΩ Impedance short circuit for 1hour	Ambient Temperature: T=20±5°C
Impact Resistance		Change of voltage should be under 0.02V/Cell; change of impedance should be under 5mΩ	Charge the cell 0.1C 16hrs, then leave for 1~4hrs, check battery before/after dropped Height 50cm Wooden board (thickness 30mm) Direction not specified, 3 times.	Ambient Temperature: T=20±5°C
Vibration Resistance		Change of voltage should be under 0.02V/cell; change of impedance should be under 5mΩ	Charge the battery 0.1C 16hrs, then leave for 24hrs, check Battery before/after vibration, Amplitude 1.5mm Vibration 3000CPM, Any direction for 60mins.	Ambient Temperature: T=20±5°C

CONFIGURATION & DIMENSIONS

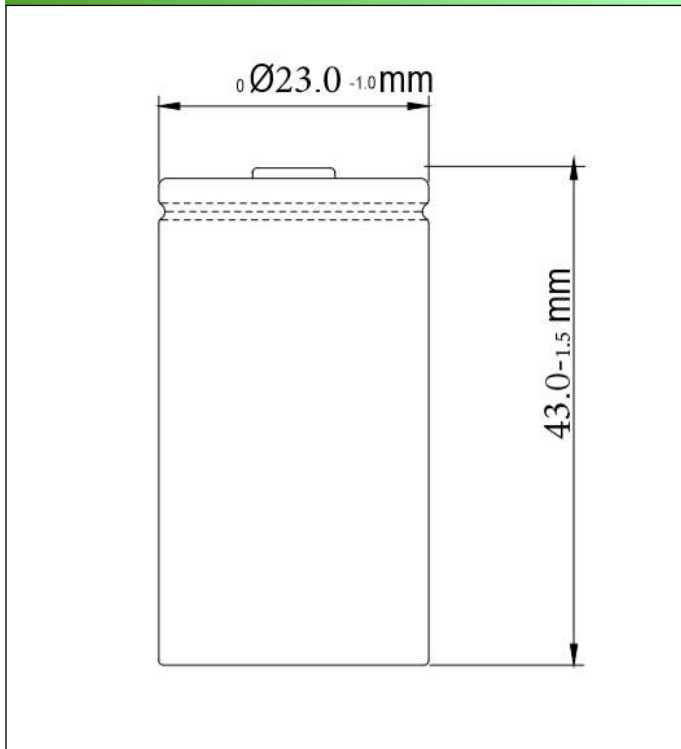

CAUTION

- 1) Reverse charging is not acceptable.
- 2) Charge before use. The cells/batteries are delivered in an uncharged state.
- 3) Do not charge/discharge with more than our specified current.
- 4) Do not short circuit the cell/battery. Permanent damage to the cell/battery may result.
- 5) Do not incinerate or mutilate the cell/battery.
- 6) Do not solder directly to the cell/battery.
- 7) The life expectancy may be reduced if the cell/battery is subjected adverse conditions like: extreme temperature, deep cycling, excessive overcharge/ over-discharge.
- 8) Store the cell/battery uncharged in a cool dry place. Always discharge batteries before bulk storage or shipment.

Notes:

Ambient Temperature.

- Approximate charge time from discharged state is for reference only.
- We recommend cells or batteries are charged and discharged at least once every 6 months.
- IEC61951-1(2003)7.4.1.1 Cycle Life:

Cycle No.	Charge	Rest	Discharge
1	0.1C×16h	None	0.25C×2h20min
2-48	0.25C×3h10min	None	0.25C×2h20min
49	0.25C×3h10min	None	0.25C to 1.0V/ cell
50	0.1C×16h	1-4h	0.2C to 1.0V/ cell

Cycles 1 to 50 shall be repeated until the discharge duration on any 50th Cycle becomes less than 3 h

EXTERNAL APPEARANCE

The cell/battery shall be free from cracks, scars, breakage, rust, discoloration, leakage nor deformation.

OTHER

- 1) The information (subject to change without prior notice) contained in this document is for reference only and should not be used as a basis for product guarantee or warranty. For applications other than those described here, please consult your nearest Battery Guy sales and Marketing office or Distributors.
- 2) Manufacturer reserves the right to alter or amend the design, model and specification without prior notice.