

## LMH6702-MIL 1.7-GHz Ultra-Low Distortion Wideband Op Amp

### 1 Features

$V_S = \pm 5\text{ V}$ ,  $T_A = 25^\circ\text{C}$ ,  $A_V = 2\text{ V/V}$ ,  $R_L = 100\ \Omega$ ,  $V_{OUT} = 2\text{ V}_{PP}$ , Typical Unless Noted:

- 2<sup>nd</sup> and 3<sup>rd</sup> Harmonics (5 MHz, SOT-23) –100/–96 dBc
- –3-dB Bandwidth ( $V_{OUT} = 0.5\text{ V}_{PP}$ ) 1.7 GHz
- Low Noise  $1.83\text{ nV}/\sqrt{\text{Hz}}$
- Fast Settling to 0.1% 13.4 ns
- Fast Slew Rate  $3100\text{ V}/\mu\text{s}$
- Supply Current 12.5 mA
- Output Current 80 mA
- Low Intermodulation Distortion (75 MHz) –67 dBc
- Improved Replacement for CLC409 and CLC449

### 2 Applications

- Flash A-D Driver
- D-A Transimpedance Buffer
- Wide Dynamic Range IF Amp
- Radar and Communication Receivers
- Line Driver
- High Resolution Video

### 3 Description

The LMH6702-MIL is a very wideband, DC-coupled monolithic operational amplifier designed specifically for wide dynamic range systems requiring exceptional signal fidelity. Benefitting from current feedback architecture, the LMH6702-MIL offers unity gain stability at exceptional speed without need for external compensation.

With its 720-MHz bandwidth ( $A_V = 2\text{ V/V}$ ,  $V_O = 2\text{ V}_{PP}$ ), 10-bit distortion levels through 60-MHz ( $R_L = 100\ \Omega$ ),  $1.83\text{-nV}/\sqrt{\text{Hz}}$  input referred noise and 12.5-mA supply current, the LMH6702-MIL is the ideal driver or buffer for high-speed flash A-D and D-A converters.

Wide dynamic range systems such as radar and communication receivers that require a wideband amplifier offering exceptional signal purity will find the low input referred noise and low harmonic and intermodulation distortion of the LMH6702-MIL an attractive high speed solution.

The LMH6702-MIL is constructed using VIP10™ complimentary bipolar process and proven current feedback architecture. The LMH6702-MIL is available in SOIC and SOT-23 packages.

#### Device Information<sup>(1)</sup>

PART NUMBER	PACKAGE	BODY SIZE (NOM)
LMH6702-MIL	SOIC (8)	4.90 mm × 3.91 mm
	SOT-23 (5)	2.90 mm × 1.60 mm

(1) For all available packages, see the orderable addendum at the end of the datasheet.

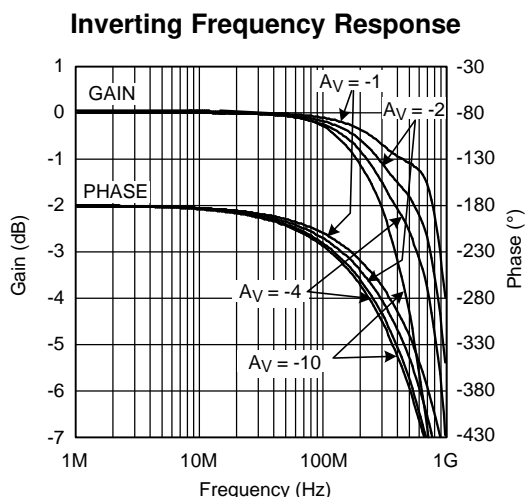

#### Harmonic Distortion vs Load and Frequency

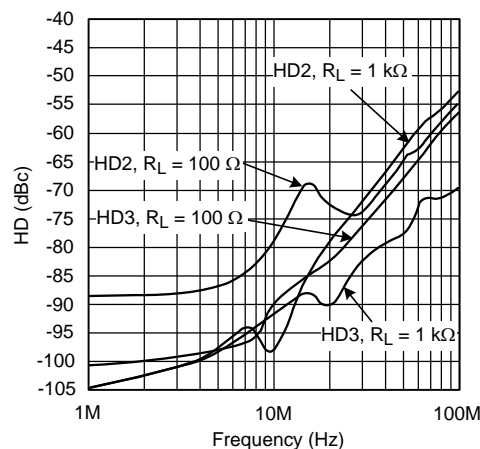

## Table of Contents

<b>1 Features</b> .....	<b>1</b>	7.3 Device Functional Modes.....	<b>12</b>
<b>2 Applications</b> .....	<b>1</b>	<b>8 Application and Implementation</b> .....	<b>13</b>
<b>3 Description</b> .....	<b>1</b>	8.1 Application Information.....	<b>13</b>
<b>4 Revision History</b> .....	<b>2</b>	8.2 Typical Application .....	<b>13</b>
<b>5 Pin Configuration and Functions</b> .....	<b>3</b>	<b>9 Power Supply Recommendations</b> .....	<b>15</b>
<b>6 Specifications</b> .....	<b>4</b>	<b>10 Layout</b> .....	<b>15</b>
6.1 Absolute Maximum Ratings .....	4	10.1 Layout Guidelines .....	15
6.2 ESD Ratings.....	4	10.2 Layout Example .....	16
6.3 Recommended Operating Conditions.....	4	<b>11 Device and Documentation Support</b> .....	<b>17</b>
6.4 Thermal Information .....	4	11.1 Documentation Support .....	17
6.5 Electrical Characteristics.....	5	11.2 Community Resources.....	17
6.6 Typical Characteristics.....	7	11.3 Trademarks .....	17
<b>7 Detailed Description</b> .....	<b>11</b>	11.4 Electrostatic Discharge Caution.....	17
7.1 Overview .....	11	11.5 Glossary .....	17
7.2 Feature Description.....	11	<b>12 Mechanical, Packaging, and Orderable Information</b> .....	<b>17</b>

## 4 Revision History

DATE	REVISION	NOTES
June 2017	*	Initial release.

## 5 Pin Configuration and Functions

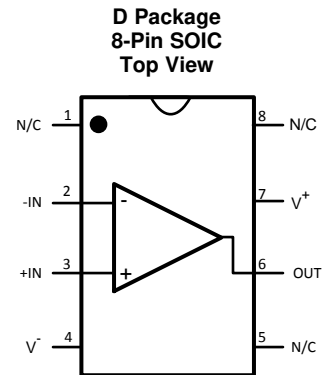
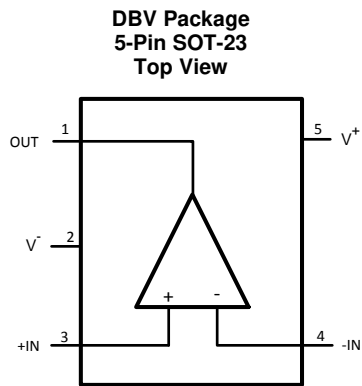

NC: No internal connection

### Pin Functions

NAME	PIN NUMBER		I/O	DESCRIPTION
	D	DBV		
-IN	2	4	I	Inverting input voltage
+IN	3	3	I	Non-inverting input voltage
N/C	1, 5, 8	–	–	No connection
OUT	6	1	O	Output
V-	4	2	I	Negative supply
V+	7	5	I	Positive supply

## 6 Specifications

### 6.1 Absolute Maximum Ratings

 over operating free-air temperature range (unless otherwise noted) <sup>(1)(2)</sup>

	MIN	MAX	UNIT
V <sub>S</sub>		±6.75	V
I <sub>OUT</sub>		See <sup>(3)</sup>	
Common mode input voltage		V <sup>-</sup> to V <sup>+</sup>	V
Maximum junction temperature		150	°C
Storage temperature	-65	150	°C
Soldering information	Infrared or convection (20 s)	235	°C
	Wave soldering (10 s)	260	°C

- (1) Stresses beyond those listed under *Absolute Maximum Ratings* may cause permanent damage to the device. These are stress ratings only, which do not imply functional operation of the device at these or any other conditions beyond those indicated under *Recommended Operating Conditions*. Exposure to absolute-maximum-rated conditions for extended periods may affect device reliability.
- (2) If Military/Aerospace specified devices are required, please contact the TI Sales Office/ Distributors for availability and specifications.
- (3) The maximum output current (I<sub>OUT</sub>) is determined by device power dissipation limitations.

### 6.2 ESD Ratings

	VALUE	UNIT
V <sub>(ESD)</sub> Electrostatic discharge	Human-body model (HBM), per ANSI/ESDA/JEDEC JS-001 <sup>(1)</sup>	±2000
	Machine Model (MM), per JEDEC specification JESD22-C101, all pins <sup>(2)</sup>	±200

- (1) Human body model: 1.5 kΩ in series with 100 pF. JEDEC document JEP155 states that 2000-V HBM allows safe manufacturing with a standard ESD control process. Manufacturing with less than 2000-V HBM is possible with the necessary precautions. Pins listed as ±2000 V may actually have higher performance.
- (2) Machine model: 0 Ω in series with 200 pF. JEDEC document JEP157 states that 200-V MM allows safe manufacturing with a standard ESD control process. Manufacturing with less than 200-V MM is possible with the necessary precautions. Pins listed as ±200 V may actually have higher performance.

### 6.3 Recommended Operating Conditions

 over operating free-air temperature range (unless otherwise noted) <sup>(1)</sup>

	MIN	MAX	UNIT
Operating temperature	-40	85	°C
Nominal supply voltage	±4	±6	V

- (1) Absolute Maximum Ratings indicate limits beyond which damage to the device may occur. Operating Ratings indicate conditions for which the device is intended to be functional, but specific performance is not ensured. For ensured specifications, see the Electrical Characteristics tables.

### 6.4 Thermal Information

THERMAL METRIC <sup>(1)</sup>	LMH6702-MIL		UNIT
	DBV (SOT-23)	D (SOIC)	
	5 PINS	8 PINS	
R <sub>θJA</sub> Junction-to-ambient thermal resistance	182	133	°C/W
R <sub>θJC(top)</sub> Junction-to-case (top) thermal resistance	139	79	°C/W
R <sub>θJB</sub> Junction-to-board thermal resistance	40	73	°C/W
ψ <sub>JT</sub> Junction-to-top characterization parameter	28	28	°C/W
ψ <sub>JB</sub> Junction-to-board characterization parameter	40	73	°C/W

- (1) For more information about traditional and new thermal metrics, see the *Semiconductor and IC Package Thermal Metrics* application report (SPRA953).

## 6.5 Electrical Characteristics

at  $A_V = 2$ ,  $V_S = \pm 5\text{ V}$ ,  $R_L = 100\ \Omega$ ,  $R_F = 237\ \Omega$  (unless otherwise noted)<sup>(1)</sup>

PARAMETER		TEST CONDITIONS	MIN <sup>(2)</sup>	TYP <sup>(3)</sup>	MAX <sup>(2)</sup>	UNIT
<b>FREQUENCY DOMAIN PERFORMANCE</b>						
SSBW <sub>SM</sub>	-3-dB Bandwidth	$V_{OUT} = 0.5\ V_{PP}$		1700		MHz
SSBW <sub>LG</sub>		$V_{OUT} = 2\ V_{PP}$		720		
LSBW <sub>LG</sub>		$V_{OUT} = 4\ V_{PP}$		480		
SSBW <sub>HG</sub>		$V_{OUT} = 2\ V_{PP}$ , $A_V = +10$		140		
GF <sub>0.1dB</sub>	0.1-dB gain flatness	$V_{OUT} = 2\ V_{PP}$		120		MHz
LPD	Linear phase deviation	DC to 100 MHz		0.09		deg
DG	Differential gain	$R_L = 150\ \Omega$ , 3.58 MHz		0.024%		
		$R_L = 150\ \Omega$ , 4.43 MHz		0.021%		
DP	Differential phase	$R_L = 150\ \Omega$ , 3.58 MHz		0.004		deg
		$R_L = 150\ \Omega$ , 4.43 MHz		0.007		
<b>TIME DOMAIN RESPONSE</b>						
t <sub>R</sub>	Rise time	2-V Step, TRS		0.87		ns
		2-V Step, TRL		0.77		
t <sub>F</sub>	Fall time	6-V Step, TRS		1.70		ns
		6-V Step, TRL		1.70		
OS	Overshoot	2-V Step		0%		
SR	Slew rate	$6\ V_{PP}$ , 40% to 60% <sup>(4)</sup>		3100		V/ $\mu$ s
T <sub>s</sub>	Settling time to 0.1%	2-V Step		13.4		ns
<b>DISTORTION AND NOISE RESPONSE</b>						
HD2L	2 <sup>nd</sup> Harmonic distortion	$2\ V_{PP}$ , 5 MHz <sup>(5)</sup> (SOT-23)		-100		dBc
		$2\ V_{PP}$ , 5 MHz <sup>(5)</sup> (SOIC)		-87		
HD2		$2V_{PP}$ , 20 MHz <sup>(5)</sup> (SOT-23)		-79		dBc
		$2V_{PP}$ , 20 MHz <sup>(5)</sup> (SOIC)		-72		
HD2H		$2V_{PP}$ , 60 MHz <sup>(5)</sup> (SOT-23)		-63		dBc
		$2V_{PP}$ , 60 MHz <sup>(5)</sup> (SOIC)		-64		
HD3L	3 <sup>rd</sup> Harmonic distortion	$2V_{PP}$ , 5 MHz <sup>(5)</sup> (SOT-23)		-96		dBc
		$2V_{PP}$ , 5 MHz <sup>(5)</sup> (SOIC)		-98		
HD3		$2V_{PP}$ , 20 MHz <sup>(5)</sup> (SOT-23)		-88		dBc
		$2V_{PP}$ , 20 MHz <sup>(5)</sup> (SOIC)		-82		
HD3H		$2V_{PP}$ , 60 MHz <sup>(5)</sup> (SOT-23)		-70		dBc
		$2V_{PP}$ , 60 MHz <sup>(5)</sup> (SOIC)		-65		
OIM3	IMD	75 MHz, P <sub>O</sub> = 10dBm/ tone		-67		dBc
V <sub>N</sub>	Input referred voltage noise	>1 MHz		1.83		nV/ $\sqrt{\text{Hz}}$
I <sub>N</sub>	Input referred inverting noise current	>1 MHz		18.5		pA/ $\sqrt{\text{Hz}}$
I <sub>NN</sub>	Input referred non-inverting noise current	>1 MHz		3.0		pA/ $\sqrt{\text{Hz}}$
SNF	Total input noise floor	>1 MHz		-158		dBm <sub>1Hz</sub>
INV	Total integrated input noise	1 MHz to 150 MHz		35		$\mu$ V

- (1) Electrical Table values apply only for factory testing conditions at the temperature indicated. Factory testing conditions result in very limited self-heating of the device such that  $T_J = T_A$ . No guarantee of parametric performance is indicated in the electrical tables under conditions of internal self-heating where  $T_J > T_A$ . Min/Max ratings are based on production testing unless otherwise specified.
- (2) All limits are ensured by testing or statistical analysis.
- (3) Typical numbers are the most likely parametric norm.
- (4) Slew Rate is the average of the rising and falling edges.
- (5) Harmonic distortion is strongly influenced by package type (SOT-23 or SOIC). See Application Note section under [Harmonic Distortion](#) for more information.

**Electrical Characteristics (continued)**

 at  $A_V = 2$ ,  $V_S = \pm 5\text{ V}$ ,  $R_L = 100\ \Omega$ ,  $R_F = 237\ \Omega$  (unless otherwise noted)<sup>(1)</sup>

PARAMETER		TEST CONDITIONS	MIN <sup>(2)</sup>	TYP <sup>(3)</sup>	MAX <sup>(2)</sup>	UNIT	
<b>STATIC, DC PERFORMANCE</b>							
$V_{IO}$	Input offset voltage			$\pm 1.0$	$\pm 4.5$	mV	
		$-40 \leq T_J \leq 85$			$\pm 6.0$		
$DV_{IO}$	Input offset voltage average drift	See <sup>(6)</sup>		-13		$\mu\text{V}/^\circ\text{C}$	
$I_{BN}$	Input bias current	Non-Inverting <sup>(7)</sup>		-6	-15	$\mu\text{A}$	
			$-40 \leq T_J \leq 85$		-21		
$DI_{BN}$	Input bias current average drift	Non-Inverting <sup>(6)</sup>		+40		$\text{nA}/^\circ\text{C}$	
$I_{BI}$	Input bias current	Inverting <sup>(7)</sup>		-8	$\pm 30$	$\mu\text{A}$	
			$-40 \leq T_J \leq 85$		$\pm 34$		
$DI_{BI}$	Input bias current average drift	Inverting <sup>(6)</sup>		-10		$\text{nA}/^\circ\text{C}$	
$PSRR$	Power supply rejection ratio	DC		47	52	dB	
			$-40 \leq T_J \leq 85$	45			
$CMRR$	Common mode rejection ration	DC		45	48	dB	
			$-40 \leq T_J \leq 85$	44			
$I_{CC}$	Supply current	$R_L = \infty$		11.0	12.5	16.1	mA
			$-40 \leq T_J \leq 85$	10.0		17.5	
<b>MISCELLANEOUS PERFORMANCE</b>							
$R_{IN}$	Input resistance	Non-Inverting		1.4		$\text{M}\Omega$	
$C_{IN}$	Input capacitance	Non-Inverting		1.6		pF	
$R_{OUT}$	Output resistance	Closed Loop		30		$\text{m}\Omega$	
$V_{OL}$	Output voltage range	$R_L = 100\ \Omega$		$\pm 3.3$	$\pm 3.5$	V	
			$-40 \leq T_J \leq 85$	$\pm 3.2$			
$CMIR$	Input voltage range	Common Mode		$\pm 1.9$	$\pm 2.2$	V	
$I_O$	Output current			50	80	mA	

(6) Drift determined by dividing the change in parameter at temperature extremes by the total temperature change.

(7) Negative input current implies current flowing out of the device.

### 6.6 Typical Characteristics

$T_A = 25^\circ\text{C}$ ,  $V_S = \pm 5\text{ V}$ ,  $R_L = 100\ \Omega$ ,  $R_F = 237\ \Omega$  (unless otherwise noted)

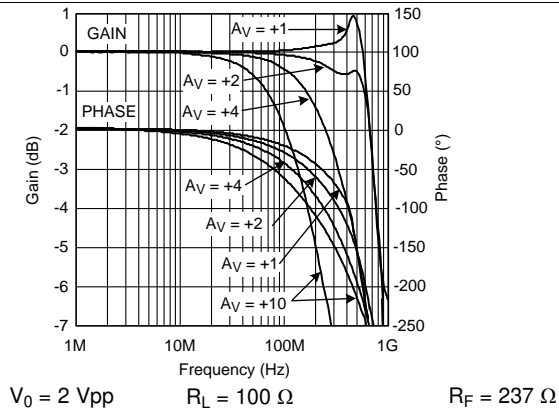

Figure 1. Non-Inverting Frequency Response

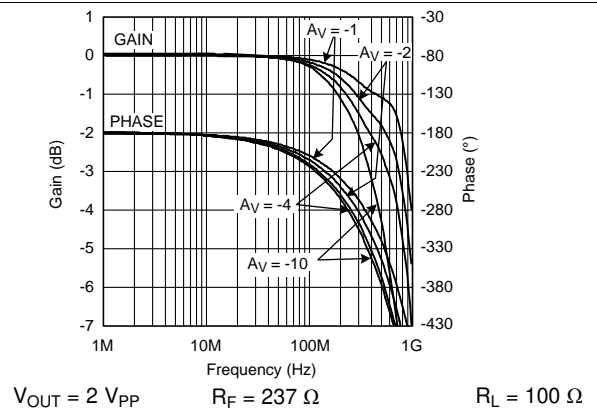

Figure 2. Inverting Frequency Response

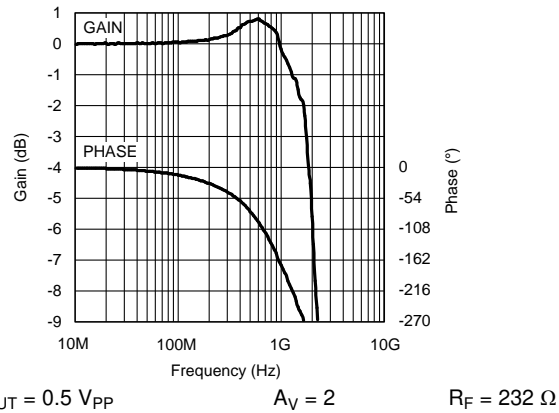

Figure 3. Small Signal Bandwidth

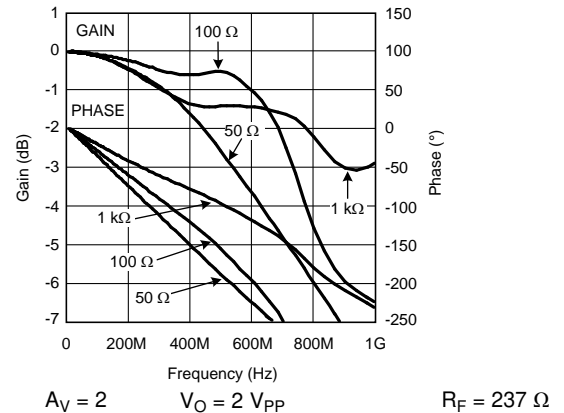

Figure 4. Frequency Response for Various  $R_L$ s,  $A_V = 2$

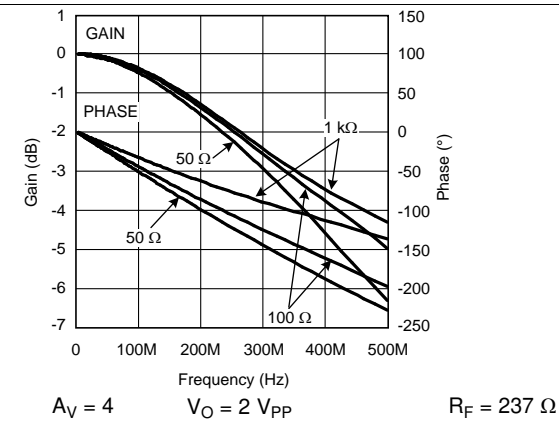

Figure 5. Frequency Response for Various  $R_L$ s,  $A_V = 4$

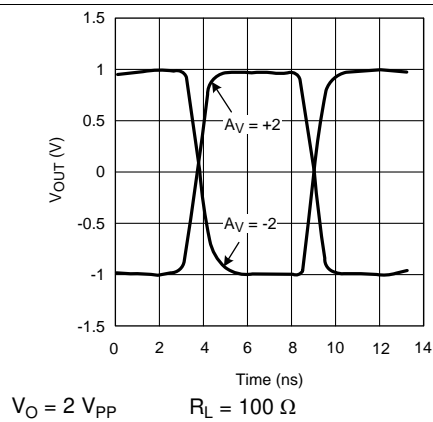

Figure 6. Step Response, 2 VPP

Typical Characteristics (continued)

$T_A = 25^\circ\text{C}$ ,  $V_S = \pm 5\text{ V}$ ,  $R_L = 100\ \Omega$ ,  $R_f = 237\ \Omega$  (unless otherwise noted)

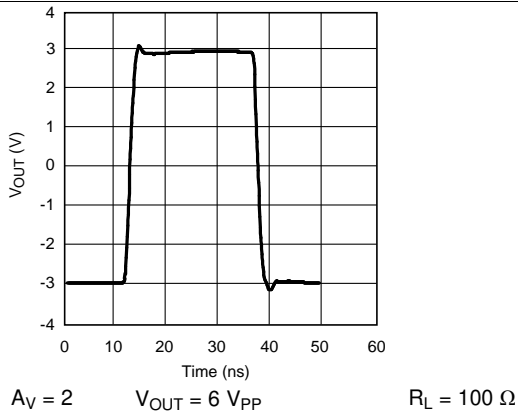

Figure 7. Step Response, 6 Vpp

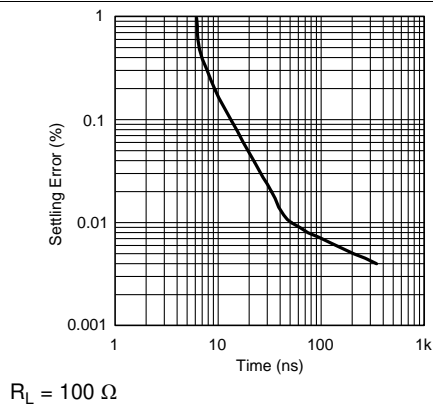

Figure 8. Percent Settling vs Time

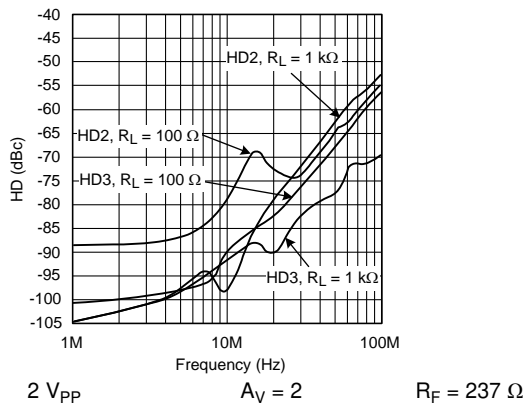

Figure 9. Harmonic Distortion vs Load and Frequency (SOIC Package)

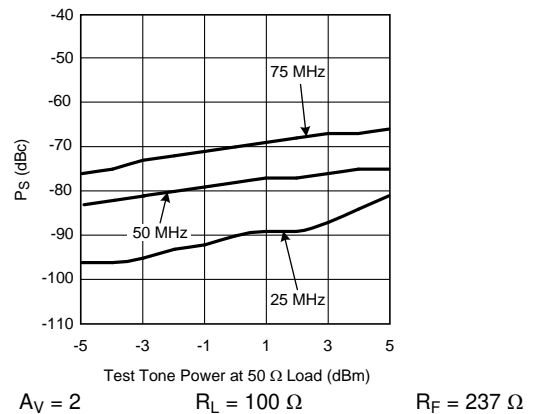

Figure 10. 2 Tone 3rd Order Spurious Level (SOIC Package)

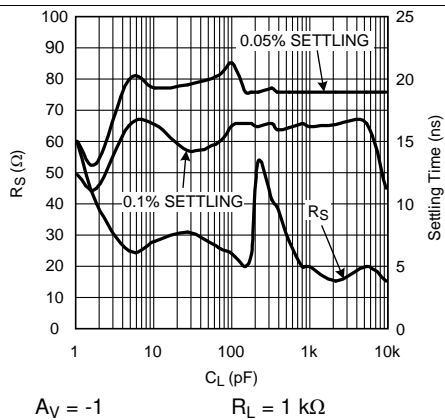

Figure 11.  $R_S$  and Settling Time vs  $C_L$

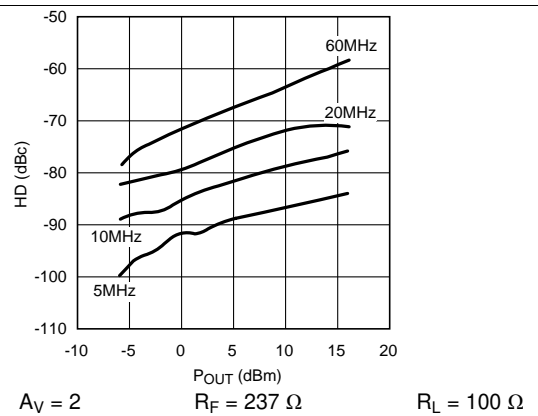

Figure 12. HD2 vs Output Power (Across 100  $\Omega$ ) (SOIC Package)



Typical Characteristics (continued)

$T_A = 25^\circ\text{C}$ ,  $V_S = \pm 5\text{ V}$ ,  $R_L = 100\ \Omega$ ,  $R_f = 237\ \Omega$  (unless otherwise noted)

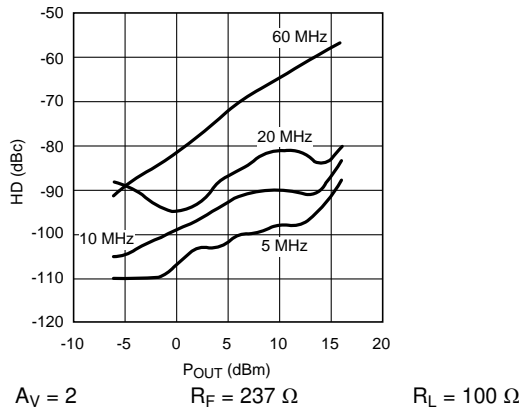

Figure 13. HD3 vs Output Power (Across 100 Ω) (SOIC Package)

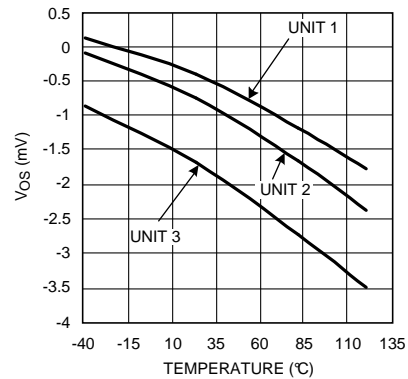

Figure 14. Input Offset for 3 Representative Units

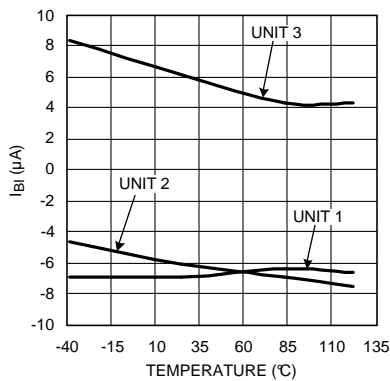

Figure 15. Inverting Input Bias for 3 Representative Units

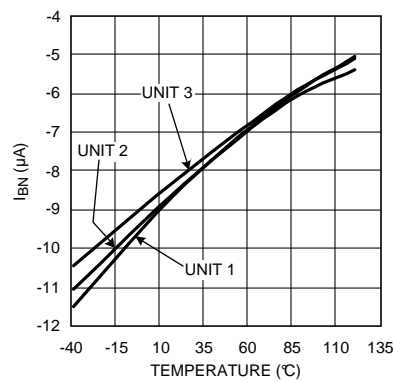

Figure 16. Non-Inverting Input Bias for 3 Representative Units

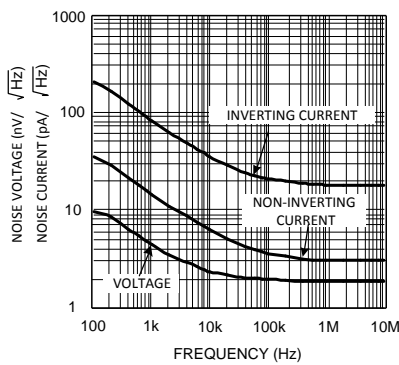

Figure 17. Noise

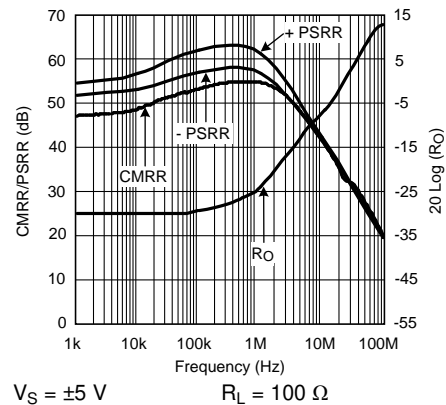

Figure 18. CMRR, PSRR,  $R_{OUT}$

Typical Characteristics (continued)

$T_A = 25^\circ\text{C}$ ,  $V_S = \pm 5\text{ V}$ ,  $R_L = 100\ \Omega$ ,  $R_f = 237\ \Omega$  (unless otherwise noted)

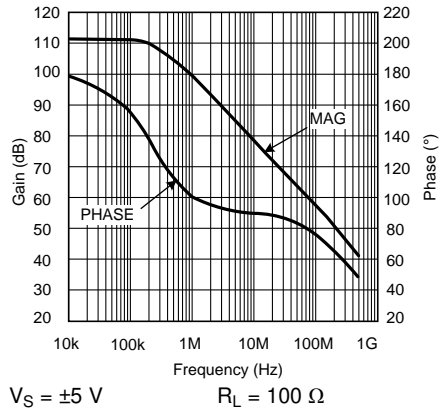

Figure 19. Transimpedance

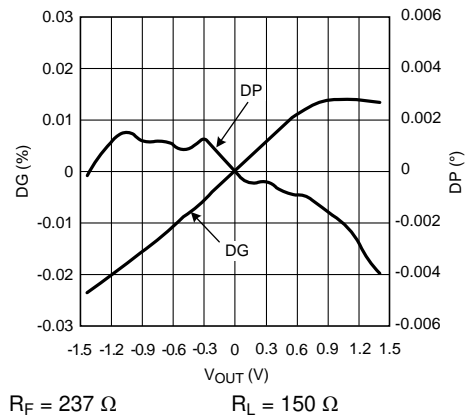

Figure 20. DG/DP (NTSC)

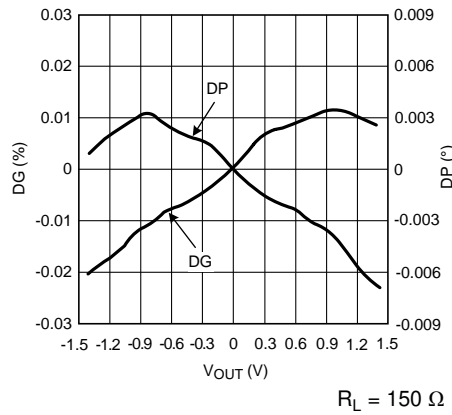

Figure 21. DG/DP (PAL)

## 7 Detailed Description

### 7.1 Overview

The LMH6702-MIL has been optimized for exceptionally low harmonic distortion while driving very demanding resistive or capacitive loads. Generally, when used as the input amplifier to very high speed flash ADCs, the distortions introduced by the converter will dominate over the low LMH6702-MIL distortions shown in [Typical Characteristics](#).

### 7.2 Feature Description

#### 7.2.1 Harmonic Distortion

The capacitor  $C_{SS}$ , shown across the supplies in [Figure 24](#) and [Figure 25](#), is critical to achieving the lowest 2<sup>nd</sup> harmonic distortion. For absolute minimum distortion levels, it is also advisable to keep the supply decoupling currents (ground connections to  $C_{POS}$ , and  $C_{NEG}$  in [Figure 24](#) and [Figure 25](#)) separate from the ground connections to sensitive input circuitry (such as  $R_G$ ,  $R_T$ , and  $R_{IN}$  ground connections). Splitting the ground plane in this fashion and separately routing the high frequency current spikes on the decoupling caps back to the power supply (similar to *Star Connection* layout technique) ensures minimum coupling back to the input circuitry and results in best harmonic distortion response (especially 2<sup>nd</sup> order distortion).

If this layout technique has not been observed on a particular application board, designer may actually find that supply decoupling caps could adversely affect HD2 performance by increasing the coupling phenomenon already mentioned. [Figure 22](#) shows actual HD2 data on a board where the ground plane is *shared* between the supply decoupling capacitors and the rest of the circuit. Once these capacitors are removed, the HD2 distortion levels reduce significantly, especially between 10 MHz to 20 MHz, as shown in [Figure 22](#):

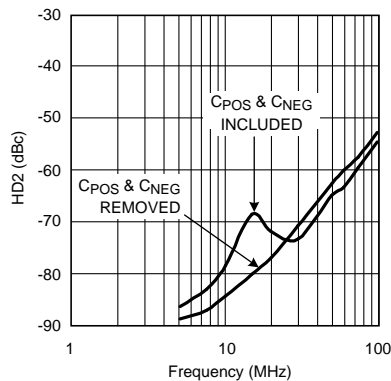
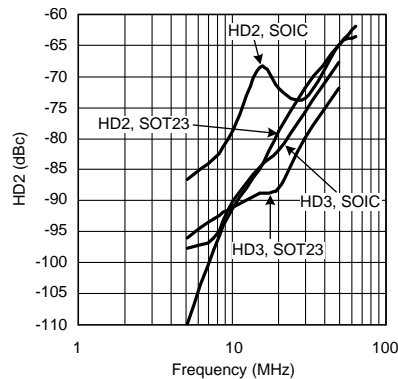

**Figure 22. Decoupling Current Adverse Effect on a Board with Shared Ground Plane**

At these extremely low distortion levels, the high frequency behavior of decoupling capacitors themselves could be significant. In general, lower value decoupling caps tend to have higher resonance frequencies making them more effective for higher frequency regions. A particular application board which has been laid out correctly with ground returns *split* to minimize coupling, would benefit the most by having low value and higher value capacitors paralleled to take advantage of the effective bandwidth of each and extend low distortion frequency range.

Another important variable in getting the highest fidelity signal from the LMH6702-MIL is the package itself. As already noted, coupling between high frequency current transients on supply lines and the device input can lead to excess harmonic distortion. An important source of this coupling is in fact through the device bonding wires. A smaller package, in general, will have shorter bonding wires and therefore lower coupling. This is true in the case of the SOT-23 compared to the SOIC package where a marked improvement in HD can be measured in the SOT-23 package. [Figure 23](#) shows the HD comparing SOT-23 to SOIC package:

## Feature Description (continued)



**Figure 23. SOIC and SOT-23 Packages Distortion Terms Compared**

The LMH6702-MIL data sheet shows both SOT-23 and SOIC data in [Electrical Characteristics](#) to aid in selecting the right package. [Typical Characteristics](#) shows SOIC package plots only.

## 7.3 Device Functional Modes

### 7.3.1 2-Tone 3<sup>rd</sup> Order Intermodulation

Figure 10 shows a relatively constant difference between the test power level and the spurious level with the difference depending on frequency. The LMH6702-MIL does not show an intercept type performance, (where the relative spurious levels change at a 2X rate versus the test tone powers), due to an internal full power bandwidth enhancement circuit that boosts the performance as the output swing increases while dissipating negligible quiescent power under low output power conditions. This feature enhances the distortion performance and full power bandwidth to match that of much higher quiescent supply current parts.

### 7.3.2 DC Accuracy and Noise

The example in [Equation 1](#) shows the output offset computation equation for the non-inverting configuration using the typical bias current and offset specifications for  $A_V = 2$ :

Output Offset:

$$V_O = (\pm I_{BN} \cdot R_{IN} \pm V_{IO}) (1 + R_F/R_G) \pm I_{BI} \cdot R_F$$

where

- $R_{IN}$  is the equivalent input impedance on the non-inverting input. (1)

Example computation for  $A_V = +2$ ,  $R_F = 237\Omega$ ,  $R_{IN} = 25\Omega$ :

$$V_O = (\pm 6 \mu A \times 25 \Omega \pm 1 mV) (1 + 237/237) \pm 8 \mu A \times 237 = \pm 4.20 mV$$
 (2)

A good design, however, should include a worst case calculation using min/max numbers in the data sheet tables, in order to ensure *worst case* operation.

Further improvement in the output offset voltage and drift is possible using the composite amplifiers described in Application Note OA--07, [Current Feedback Op Amp Applications Circuit Guide \(SNOA365\)](#). The two input bias currents are physically unrelated in both magnitude and polarity for the current feedback topology. It is not possible, therefore, to cancel their effects by matching the source impedance for the two inputs (as is commonly done for matched input bias current devices).

The total output noise is computed in a similar fashion to the output offset voltage. Using the input noise voltage and the two input noise currents, the output noise is developed through the same gain equations for each term but combined as the square root of the sum of squared contributing elements. See Application Note OA-12, [Noise Analysis for Comlinear Amplifiers \(SNOA375\)](#) for a full discussion of noise calculations for current feedback amplifiers.

## 8 Application and Implementation

### NOTE

Information in the following applications sections is not part of the TI component specification, and TI does not warrant its accuracy or completeness. TI's customers are responsible for determining suitability of components for their purposes. Customers should validate and test their design implementation to confirm system functionality.

### 8.1 Application Information

The LMH6702-MIL achieves its excellent pulse and distortion performance by using the current feedback topology. The loop gain for a current feedback op amp, and hence the frequency response, is predominantly set by the feedback resistor value. The LMH6702-MIL is optimized for use with a 237-Ω feedback resistor. Using lower values can lead to excessive ringing in the pulse response while a higher value will limit the bandwidth.

### 8.2 Typical Application

#### 8.2.1 Feedback Resistor

The LMH6702-MIL achieves its excellent pulse and distortion performance by using the current feedback topology. The loop gain for a current feedback op amp, and hence the frequency response, is predominantly set by the feedback resistor value. The LMH6702-MIL is optimized for use with a 237-Ω feedback resistor. Using lower values can lead to excessive ringing in the pulse response while a higher value will limit the bandwidth.

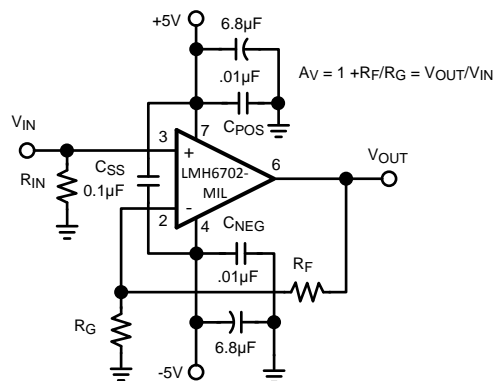

Copyright © 2017, Texas Instruments Incorporated

Figure 24. Recommended Non-Inverting Gain Circuit

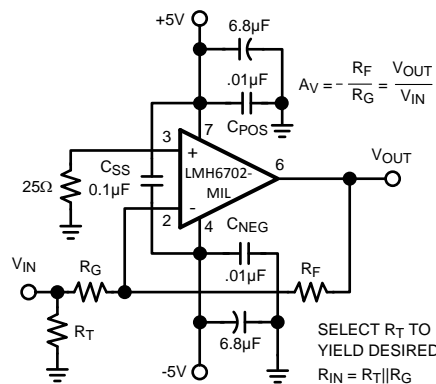

Copyright © 2017, Texas Instruments Incorporated

Figure 25. Recommended Inverting Gain Circuit

## Typical Application (continued)

### 8.2.2 Design Requirements

The exceptional performance and uniquely targeted superior technical specifications of the LMH6702-MIL make it a natural choice for high speed data acquisition applications as a front end amplifier driving the input of a high performance ADC. Of these specifications, the following can be discussed in more detail:

1. A bandwidth of 1.7 GHz and relative insensitivity of bandwidth to closed loop gain (characteristic of Current Feedback architecture when compared to the traditional voltage feedback architecture) as shown in [Figure 1](#).
2. Ultra-low distortion approaching -87 dBc at the lower frequencies and exceptional noise performance (see [Figure 9](#) and [Figure 17](#)).
3. Fast settling in less than 20 ns (see [Figure 27](#)).

As the input of an ADC could be capacitive in nature and could also alternate in capacitance value during a typical acquisition cycle, the driver amplifier (LMH6702-MIL in this case) should be designed so that it avoids instability, peaking, or other undesirable artifacts.

For Capacitive Load Drive, see [Figure 26](#), which shows a typical application using the LMH6702-MIL to drive an ADC.

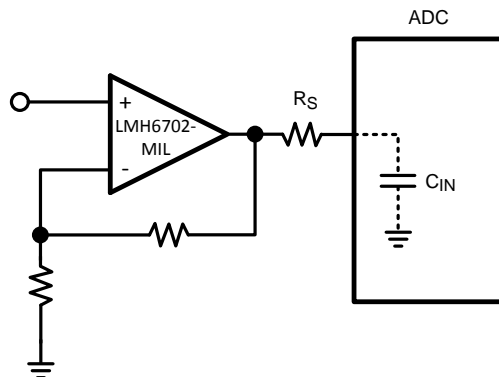

Copyright © 2017, Texas Instruments Incorporated

**Figure 26. Input Amplifier to ADC**

### 8.2.3 Detailed Design Procedure

The series resistor,  $R_S$ , between the amplifier output and the ADC input is critical to achieving best system performance. This load capacitance, if applied directly to the output pin, can quickly lead to unacceptable levels of ringing in the pulse response. [Figure 27](#) in *Application Curve* ( $R_S$  and Settling Time vs  $C_L$ ) is an excellent starting point for selecting  $R_S$ . The value derived in that plot minimizes the step settling time into a fixed discrete capacitive load with the output driving a very light resistive load (1 k $\Omega$ ). Sensitivity to capacitive loading is greatly reduced once the output is loaded more heavily. Therefore, for cases where the output is heavily loaded,  $R_S$  value may be reduced. The exact value may best be determined experimentally for these cases.

In applications where the LMH6702-MIL is replacing the CLC409, care must be taken when the device is lightly loaded and some capacitance is present at the output. Due to the much higher frequency response of the LMH6702-MIL compared to the CLC409, there could be increased susceptibility to low value output capacitance (parasitic or inherent to the board layout or otherwise being part of the output load). As already mentioned, this susceptibility is most noticeable when the LMH6702-MIL's resistive load is light. Parasitic capacitance can be minimized by careful lay out. Addition of an output snubber R-C network will also help by increasing the high frequency resistive loading.

Referring back to [Figure 26](#), it must be noted that several additional constraints should be considered in driving the capacitive input of an ADC. There is an option to increase  $R_S$ , band-limiting at the ADC input for either noise or Nyquist band-limiting purposes. However, increasing  $R_S$  too much can induce an unacceptably large input glitch due to switching transients coupling through from the *convert* signal. Also,  $C_{IN}$  is oftentimes a voltage dependent capacitance. This input impedance non-linearity will induce distortion terms that will increase as  $R_S$  is increased. Only slight adjustments up or down from the recommended  $R_S$  value should therefore be attempted in optimizing system performance.

## Typical Application (continued)

### 8.2.4 Application Curve

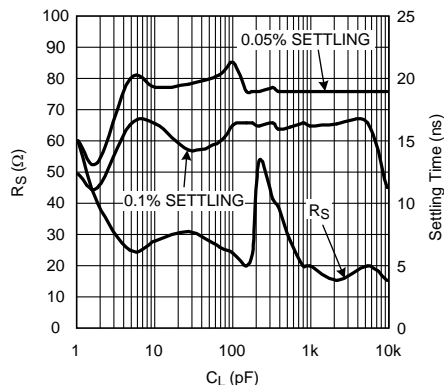

$$A_V = -1$$

$$R_L = 1 \text{ k}\Omega$$

Figure 27.  $R_S$  and Settling Time vs  $C_L$

## 9 Power Supply Recommendations

The LMH6702-MIL can operate off a single supply or with dual supplies as long as the input CM voltage range (CMIR) has the required headroom to either supply rail. Supplies should be decoupled with low inductance, often ceramic, capacitors to ground less than 0.5 inches from the device pins. The use of ground plane is recommended, and as in most high speed devices, it is advisable to remove ground plane close to device sensitive pins such as the inputs.

## 10 Layout

### 10.1 Layout Guidelines

Generally, a good high frequency layout will keep power supply and ground traces away from the inverting input and output pins. Parasitic capacitances on these nodes to ground will cause frequency response peaking and possible circuit oscillations. See *Frequent Faux Pas in Applying Wideband Current Feedback Amplifiers*, Application Note OA-15 (SNOA367). Texas Instruments suggests the following evaluation boards as a guide for high frequency layout and as an aid in device testing and characterization. See Table 1 for details.

The LMH6702-MIL evaluation board(s) is a good example of high frequency layout techniques as a reference. General high-speed, signal-path layout suggestions include:

- Continuous ground planes are preferred for signal routing with matched impedance traces for longer runs. However, open up both ground and power planes around the capacitive sensitive input and output device pins as shown in Figure 28. After the signal is sent into a resistor, parasitic capacitance becomes more of a bandlimiting issue and less of a stability issue.
- Use good, high-frequency decoupling capacitors (0.1  $\mu\text{F}$ ) on the ground plane at the device power pins as shown in Figure 28. Higher value capacitors (2.2  $\mu\text{F}$ ) are required, but may be placed further from the device power pins and shared among devices. For best high-frequency decoupling, consider X2Y supply-decoupling capacitors that offer a much higher self-resonance frequency over standard capacitors.
- When using differential signal routing over any appreciable distance, use microstrip layout techniques with matched impedance traces.
- The input summing junction is very sensitive to parasitic capacitance. Connect any  $R_f$ , and  $R_g$  elements into the summing junction with minimal trace length to the device pin side of the resistor, as shown in Figure 29. The other side of these elements can have more trace length if needed to the source or to ground.

## 10.2 Layout Example

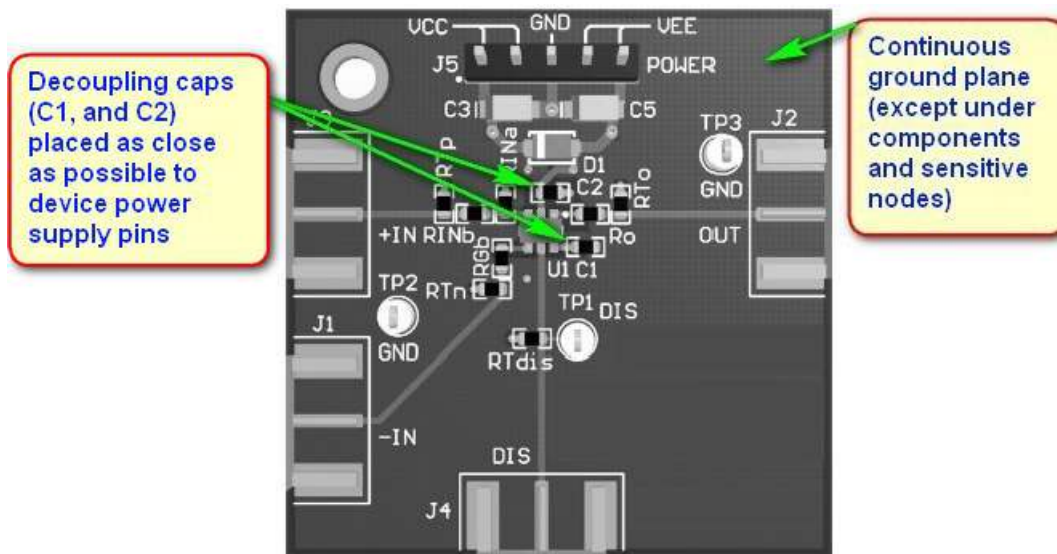

Figure 28. LMH6702-MIL Evaluation Board Layer 1

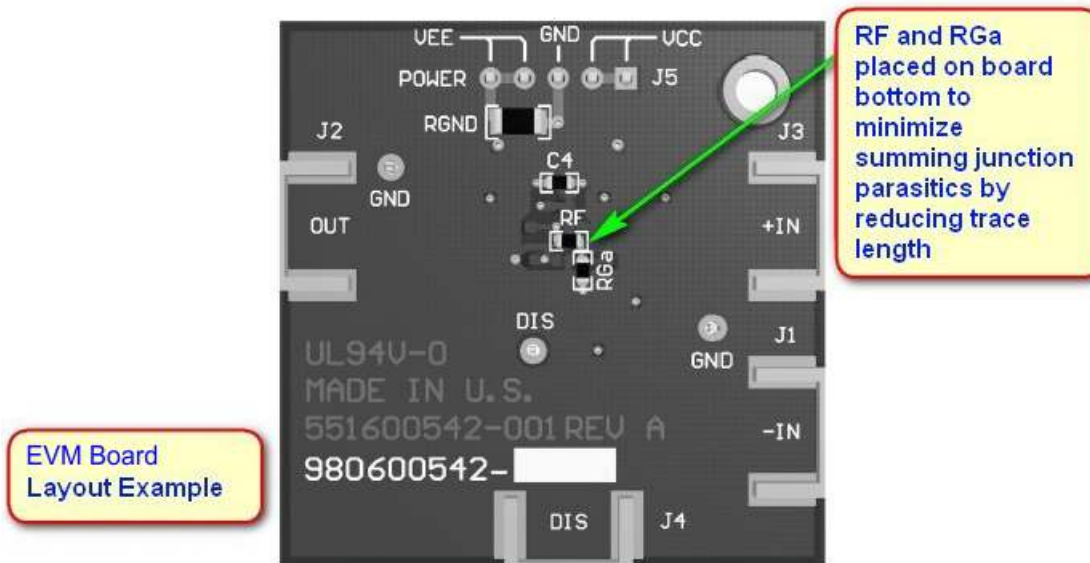

Figure 29. LMH6702-MIL Evaluation Board Layer 2

Table 1. Evaluation Board Comparison

DEVICE	PACKAGE	EVALUATION BOARD PART NUMBER
LMH6702-MILMF	SOT-23	LMH730216
LMH6702-MILMA	SOIC	LMH730227



## 11 Device and Documentation Support

### 11.1 Documentation Support

#### 11.1.1 Related Documentation

For related documentation, see the following:

- *Absolute Maximum Ratings for Soldering* ([SNOA549](#))
- *Current Feedback Op Amp Applications Circuit Guide*, Application Note OA--07 ([SNOA365](#))
- *Frequent Faux Pas in Applying Wideband Current Feedback Amplifiers*, Application Note OA-15 ([SNOA367](#))
- *Noise Analysis for Comlinear Amplifiers*, Application Note OA-12 ([SNOA375](#))
- *Semiconductor and IC Package Thermal Metrics* ([SPRA953](#))

### 11.2 Community Resources

The following links connect to TI community resources. Linked contents are provided "AS IS" by the respective contributors. They do not constitute TI specifications and do not necessarily reflect TI's views; see TI's [Terms of Use](#).

**TI E2E™ Online Community** *TI's Engineer-to-Engineer (E2E) Community*. Created to foster collaboration among engineers. At [e2e.ti.com](#), you can ask questions, share knowledge, explore ideas and help solve problems with fellow engineers.

**Design Support** *TI's Design Support* Quickly find helpful E2E forums along with design support tools and contact information for technical support.

### 11.3 Trademarks

VIP10, E2E are trademarks of Texas Instruments.

All other trademarks are the property of their respective owners.

### 11.4 Electrostatic Discharge Caution



These devices have limited built-in ESD protection. The leads should be shorted together or the device placed in conductive foam during storage or handling to prevent electrostatic damage to the MOS gates.

### 11.5 Glossary

[SLYZ022](#) — *TI Glossary*.

This glossary lists and explains terms, acronyms, and definitions.

## 12 Mechanical, Packaging, and Orderable Information

The following pages include mechanical, packaging, and orderable information. This information is the most current data available for the designated devices. This data is subject to change without notice and revision of this document. For browser-based versions of this data sheet, refer to the left-hand navigation.

**PACKAGING INFORMATION**

Orderable Device	Status (1)	Package Type	Package Drawing	Pins	Package Qty	Eco Plan (2)	Lead finish/ Ball material (6)	MSL Peak Temp (3)	Op Temp (°C)	Device Marking (4/5)	Samples
LMH6702 MDC	ACTIVE	DIESALE	Y	0	754	RoHS & Green	Call TI	Level-1-NA-UNLIM	-40 to 85		Samples

(1) The marketing status values are defined as follows:

**ACTIVE:** Product device recommended for new designs.

**LIFEBUY:** TI has announced that the device will be discontinued, and a lifetime-buy period is in effect.

**NRND:** Not recommended for new designs. Device is in production to support existing customers, but TI does not recommend using this part in a new design.

**PREVIEW:** Device has been announced but is not in production. Samples may or may not be available.

**OBSOLETE:** TI has discontinued the production of the device.

(2) **RoHS:** TI defines "RoHS" to mean semiconductor products that are compliant with the current EU RoHS requirements for all 10 RoHS substances, including the requirement that RoHS substance do not exceed 0.1% by weight in homogeneous materials. Where designed to be soldered at high temperatures, "RoHS" products are suitable for use in specified lead-free processes. TI may reference these types of products as "Pb-Free".

**RoHS Exempt:** TI defines "RoHS Exempt" to mean products that contain lead but are compliant with EU RoHS pursuant to a specific EU RoHS exemption.

**Green:** TI defines "Green" to mean the content of Chlorine (Cl) and Bromine (Br) based flame retardants meet JS709B low halogen requirements of <=1000ppm threshold. Antimony trioxide based flame retardants must also meet the <=1000ppm threshold requirement.

(3) MSL, Peak Temp. - The Moisture Sensitivity Level rating according to the JEDEC industry standard classifications, and peak solder temperature.

(4) There may be additional marking, which relates to the logo, the lot trace code information, or the environmental category on the device.

(5) Multiple Device Markings will be inside parentheses. Only one Device Marking contained in parentheses and separated by a "-" will appear on a device. If a line is indented then it is a continuation of the previous line and the two combined represent the entire Device Marking for that device.

(6) Lead finish/Ball material - Orderable Devices may have multiple material finish options. Finish options are separated by a vertical ruled line. Lead finish/Ball material values may wrap to two lines if the finish value exceeds the maximum column width.

**Important Information and Disclaimer:** The information provided on this page represents TI's knowledge and belief as of the date that it is provided. TI bases its knowledge and belief on information provided by third parties, and makes no representation or warranty as to the accuracy of such information. Efforts are underway to better integrate information from third parties. TI has taken and continues to take reasonable steps to provide representative and accurate information but may not have conducted destructive testing or chemical analysis on incoming materials and chemicals. TI and TI suppliers consider certain information to be proprietary, and thus CAS numbers and other limited information may not be available for release.

In no event shall TI's liability arising out of such information exceed the total purchase price of the TI part(s) at issue in this document sold by TI to Customer on an annual basis.

## IMPORTANT NOTICE AND DISCLAIMER

TI PROVIDES TECHNICAL AND RELIABILITY DATA (INCLUDING DATASHEETS), DESIGN RESOURCES (INCLUDING REFERENCE DESIGNS), APPLICATION OR OTHER DESIGN ADVICE, WEB TOOLS, SAFETY INFORMATION, AND OTHER RESOURCES "AS IS" AND WITH ALL FAULTS, AND DISCLAIMS ALL WARRANTIES, EXPRESS AND IMPLIED, INCLUDING WITHOUT LIMITATION ANY IMPLIED WARRANTIES OF MERCHANTABILITY, FITNESS FOR A PARTICULAR PURPOSE OR NON-INFRINGEMENT OF THIRD PARTY INTELLECTUAL PROPERTY RIGHTS.

These resources are intended for skilled developers designing with TI products. You are solely responsible for (1) selecting the appropriate TI products for your application, (2) designing, validating and testing your application, and (3) ensuring your application meets applicable standards, and any other safety, security, or other requirements. These resources are subject to change without notice. TI grants you permission to use these resources only for development of an application that uses the TI products described in the resource. Other reproduction and display of these resources is prohibited. No license is granted to any other TI intellectual property right or to any third party intellectual property right. TI disclaims responsibility for, and you will fully indemnify TI and its representatives against, any claims, damages, costs, losses, and liabilities arising out of your use of these resources.

TI's products are provided subject to TI's Terms of Sale ([www.ti.com/legal/termsofsale.html](http://www.ti.com/legal/termsofsale.html)) or other applicable terms available either on [ti.com](http://ti.com) or provided in conjunction with such TI products. TI's provision of these resources does not expand or otherwise alter TI's applicable warranties or warranty disclaimers for TI products.

Mailing Address: Texas Instruments, Post Office Box 655303, Dallas, Texas 75265  
Copyright © 2020, Texas Instruments Incorporated