

Redundancy Unit

S8VK-R

Contribute to build high reliable systems
Compact and Cost-effective solution
for Back-up applications
Easy setup for system reliability
requirement

- Redundancy operating LED for the status confirmation
- A signal output for failure detection of power supplies
- By adjusting the power supply voltage to light up Balance LED, the lifetime of power supplies will be more than twice. *1
- Wide range input
DC5-30V (S8VK-R10), DC10-60V (S8VK-R20)
- Wide operation temperature range: -40 to 70 °C
- Safety standards:
UL508/60950-1, CSA C22.2 No. 107.1/60950-1
EN50178, EN60950-1 Lloyd's standards *2
- EMS: EN61000-6-2
EMI: EN61000-6-3
- 5 year warranty *3

*1. The lifetime will depend on the connected power supply.
Refer to *Functions* on page 5.

*2. Scheduled to obtain certification in September, 2013.

*3. Five-year warranty conditions: Rated input voltage, 80% load, Ambient operating temperature: 40°C, Standard mounting.



⚠ Refer to *Safety Precautions for All Power Supplies and Safety Precautions* on page 9.

Model Number Structure

Model Number Legend

Note: Not all combinations are possible. Refer to *List of Models* in *Ordering Information*, below.

S8VK-R □□
1

1. Output current

- 10: 10 A
- 20: 20 A

Ordering Information

Note: For details on normal stock models, contact your nearest OMRON representative.

Input voltage	Output current	Model number
DC5-30V	10 A	S8VK-R10
DC10-60V	20 A	S8VK-R20

S8VK-R

Specifications

Ratings, Characteristics, and Functions

Item	Output Current		10 A	20 A
Input	Voltage		5 to 30 VDC	10 to 60 VDC
	Current		2x 0 to 5 A 1x 0 to 10 A	2x 0 to 10 A 1x 0 to 20 A
Output	Current	Continuous	10 A	20 A
		Power Boost	12 A (Refer to Engineering Data)	24 A (Refer to Engineering Data)
Voltage drop	Input to Output		0.56 V typ. 2x5 A 0.63 V typ. 1x10 A 0.7 V max. (-40°C 1x10 A)	0.67 V typ. 2x10 A 0.78 V typ. 1x20 A 0.9 V max. (-40°C 1x20 A)
Power losses			6.5 W 2x5 A 7.1 W 1x10 A 0.8 W 0 A	15.8 W 2x10 A 18.0 W 1x20 A 0.8 W 0 A
Additional functions	REDUNDANCY OK	Indicator	Lighting: Voltage difference between Vin1 and Vin2 is less than 2.4 V typ. (color: green)	
		Contact	Photo switch contact ON: Voltage difference between Vin1 and Vin2 is less than 2.4 V typ. Contact Ratings: 30 VDC, 50 mA	
	BALANCE	Indicator	Lighting: Voltage difference between Vin1 and Vin2 is less than 50 mV typ. (color: green)	
Others	Ambient operating temperature		-40 to 70°C (Refer to Engineering Data)	
	Storage temperature		-40 to 85°C	
	Ambient operating humidity		0% to 95% (Storage humidity: 0% to 95%)	
	Dielectric strength (detection current: 20 mA)		1.0 kVAC for 1 min. (between all inputs outputs and \perp terminal) 0.5 kVAC for 1 min. (between all inputs outputs and Signal contact)	
	Vibration resistance		10 to 55 Hz, 0.375-mm single amplitude for 2 h each in X, Y, and Z directions 10 to 150 Hz, 0.35-mm single amplitude (5 G max.) for 80 min each in X, Y, and Z directions	
	Shock resistance		150 m/s ² , 3 times each in \pm X, \pm Y, and \pm Z directions	
	EMI	Conducted Emission	Conforms to EN61204-3 EN55011 Class B and based on FCC Class B	
		Radiated Emission	Conforms to EN61204-3 EN55011 Class B	
	EMS		Conforms to EN61000-6-2	
	Approved Standards		UL Listed: UL508 (Listing) UL UR: UL60950-1 (Recognition) cUL: CSA C22.2 No.107.1 cUR: CSA C22.2 No.60950-1 EN: EN50178, EN60950-1 Lloyd's standards *	
	Degree of protection		IP20 by EN/IEC60529	
Weight		183 g	462 g	

* Scheduled to obtain certification in September, 2013.

Connections

Block Diagrams

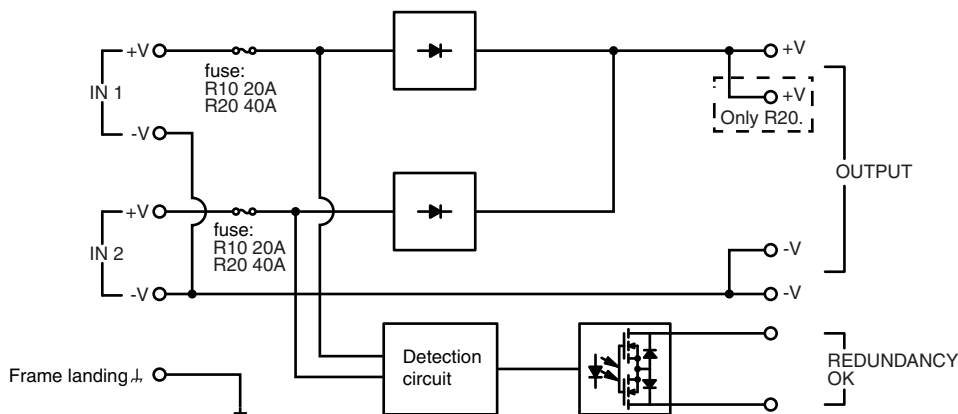

Construction and Nomenclature

Nomenclature

10 A Models
S8VK-R10

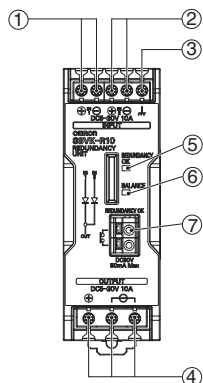

20 A Models
S8VK-R20

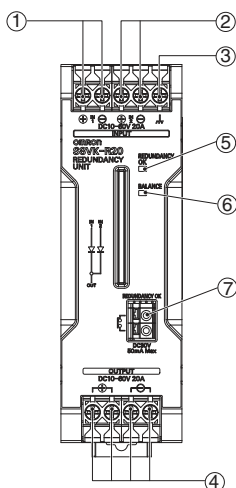

No.	Name	Function
1	Input terminal 1	Connect the input 1 lines to these terminals.
2	Input terminal 2	Connect the input 2 lines to these terminals.
3	⏏ terminal	Connect the ground line to these terminals.
4	Output terminal	Connect the load lines to these terminals.
5	Status indicator (redundancy OK: Green)	Lighting: Voltage difference between Vin1 and Vin2 is less than 2.4 V typ.
6	Status indicator (voltage balance: Green)	Lighting: Voltage difference between Vin1 and Vin2 is less than 50 mV typ.
7	Status contact (redundancy OK: photo switch)	Photo switch contact ON: Voltage difference between Vin1 and Vin2 is less than 2.4 V typ.

S8VK-R

Engineering Data

Derating Curve

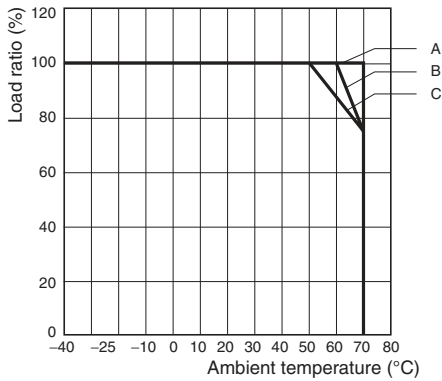

- A: Standard mounting
- B: Standard mounting, when contact mounted with S8VK-G
60°C and over: the derating is 2.5%/°C (when contact mounted with S8VK-G)
- C: Face-up mounting
50°C and over: the derating is 1.25%/°C

Mounting

(A) Standard (Vertical) mounting

(B) Contact Mounting

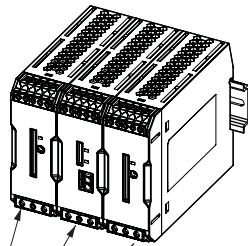
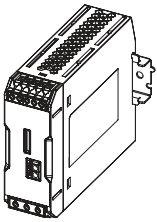

(C) Face-up mounting

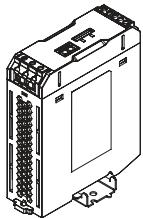

POWER SUPPLY (S8VK-G)

Power Boost Function

This function is possible when used in combination with S8VK-G (All Models).

Power Boost is a function that can output the temporary repeated boost current larger than the rated current.

However, it should meet the following four Boost current conditions.

1. Time that the boost current flows: t_1
2. The maximum value of the boost current: I_p
3. The average output current: I_{ave}
4. The time ratio of the boost current flow: Duty

Note: Boost current conditions

- $t_1 \leq 10$ s
- $I_p \leq$ Rated boost current
- $I_{ave} \leq$ Rated current

$$\text{Duty} = \frac{t_1}{t_1 + t_2} \times 100 [\%] \leq 30\%$$

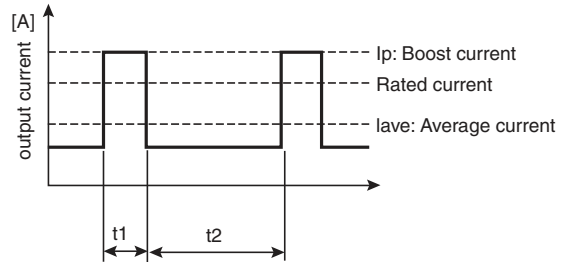

- Do not allow the boost current to continue for more than 10 seconds.
Also, do not let the duty cycle exceed the boost current conditions. These conditions may damage the Power supply.
- Ensure that the average current of one cycle of the boost current does not exceed the rated output current. This may damage the Power Supply.
- Lessen the load of the boost load current by adjusting the ambient temperature and the mounting direction.

Combinations with the S8VK-G

Power supply model	Redundant unit model	
	Redundancy	Higher capacity
S8VK-G015□□	S8VK-R10	S8VK-R10
S8VK-G030□□		
S8VK-G060□□		
S8VK-G12024		
S8VK-G24024	S8VK-R20	S8VK-R20
S8VK-G24048		
S8VK-G48024		
S8VK-G48048		

Functions

Functions

Status	Output	Display
Redundancy	Relay switch output: OFF (Normally ON)	Green
Voltage Balance	---	Green

Status Functions

Functions	Operation
Redundancy Status (Refer to Chart 1.)	Redundancy OK signal and LED will turn ON and light up when the input voltage difference is 2.4 V typ or less. The signal and LED will detect the failure of a power supply on one side, or connecting errors of power supply voltage.
Voltage Balance Status (Refer to Chart 1.)	Balance LED will light up when the input voltage difference is 50 mV typ or less. By adjusting the input voltage to light up LED, output current of each power supply will be balanced. The lifetime as a power supply system will be more than twice comparing when there is only one power supply. Applicable models: S8VK-G03005, S8VK-G06012, S8VK-G12024, S8VK-G240□□, S8VK-G480□□ By adjusting the input voltage to light up LED, the fluctuation of the output voltage will be less when one of the power supply breaks.

Chart 1: Operation Timing

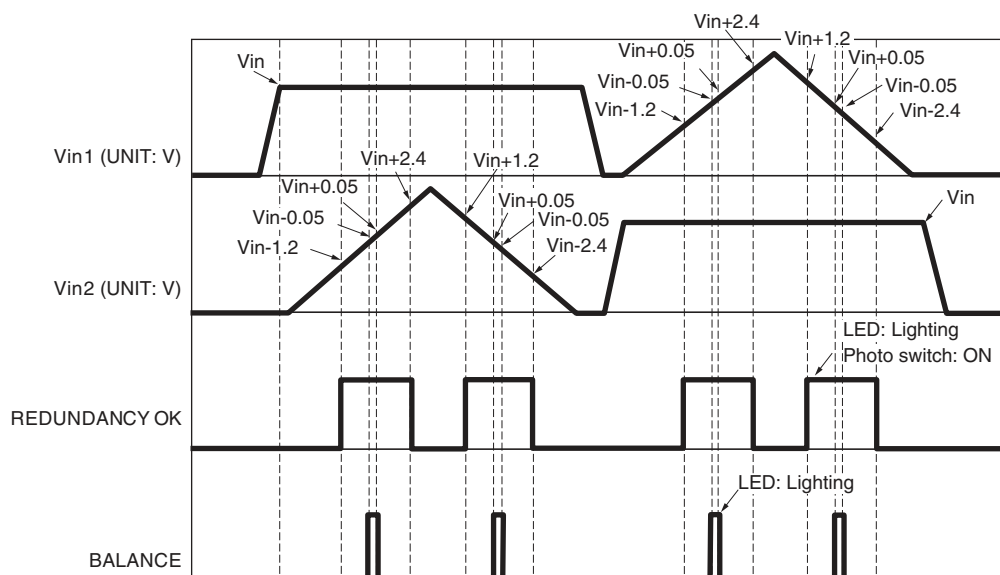

Reference Value

	Value
Reliability (MTBF)	S8VK-R10: 720,000 hrs. S8VK-R20: 680,000 hrs.
Definition	MTBF stands for Mean Time Between Failures, which is calculated according to the probability of accidental device failures, and indicates reliability of devices. Therefore, it does not necessarily represent a life of the product.
Life expectancy	10 yrs. Min.
Definition	The life expectancy indicates average operating hours under the ambient temperature of 40°C and a load rate of 50%. Normally this is determined by the life expectancy of the built-in aluminum electrolytic capacitor.

S8VK-R

Dimensions

(Unit: mm)

S8VK-R10

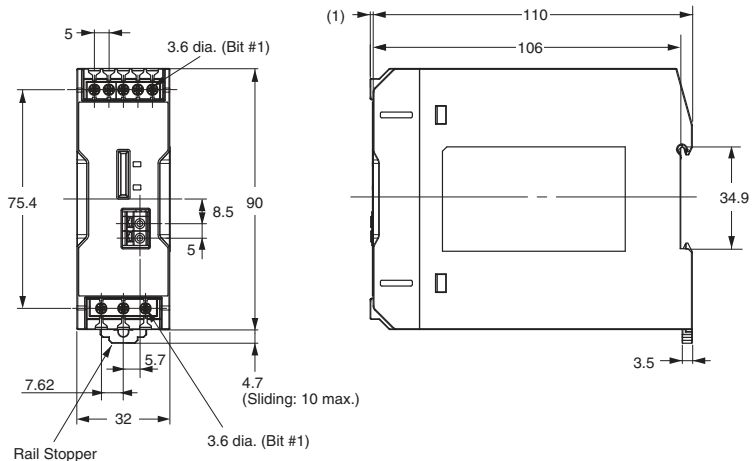

S8VK-R20

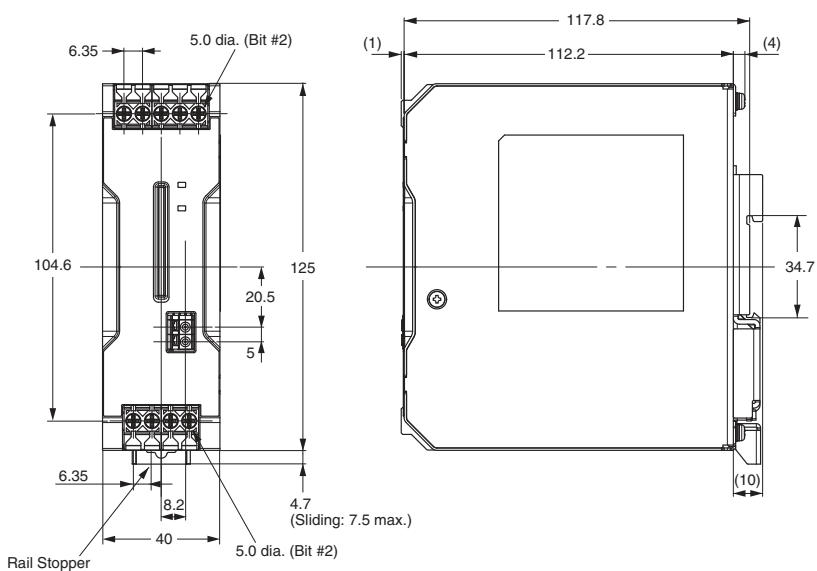

DIN Rail (Order Separately)

Note: All units are in millimeters unless otherwise indicated.

Mounting Rail (Material: Aluminum)

PFP-100N

PFP-50N

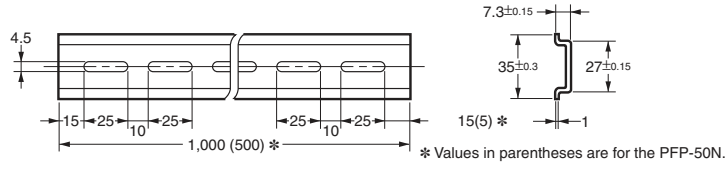
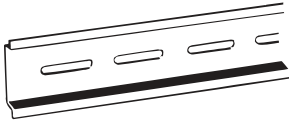

Mounting Rail (Material: Aluminum)

PFP-100N2

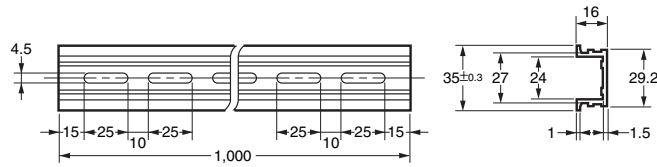

End Plate

PFP-M

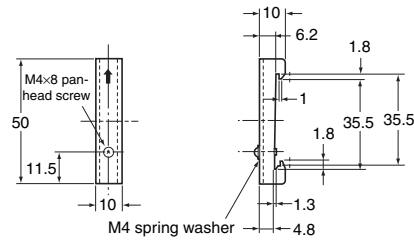
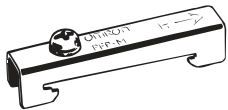

Note: If there is a possibility that the Unit will be subject to vibration or shock, use a steel DIN Rail. Otherwise, metallic filings may result from aluminum abrasion.

Mounting Brackets

Name	Model
Front-mounting bracket (for S8VK-R10)	S82Y-VS10F
Front-mounting bracket (for S8VK-R20)	S82Y-VK10F
Side-mounting bracket (for S8VK-R10)	S82Y-VS10S
Side-mounting bracket (for S8VK-R20)	S82Y-VK10S



Type	Model	Dimensions	Appearance
Front-mounting bracket (for S8VK-R10)	S82Y-VS10F		
Front-mounting bracket (for S8VK-R20)	S82Y-VK10F		
Side-mounting bracket (for S8VK-R10)	S82Y-VS10S		<p>Left-side mounting Right-side mounting</p>
Side-mounting bracket (for S8VK-R20)	S82Y-VK10S		<p>Left-side mounting Right-side mounting</p>

Safety Precautions

Warning Indications

 CAUTION	Indicates a potentially hazardous situation which, if not avoided, may result in minor or moderate injury or in property damage.
Precautions for Safe Use	Supplementary comments on what to do or avoid doing, to use the product safely.
Precautions for Correct Use	Supplementary comments on what to do or avoid doing, to prevent failure to operate, malfunction or undesirable effect on product performance.

Meaning of Product Safety Symbols

	Used to warn of the risk of minor injury caused by high temperatures.
	Used for general mandatory action precautions for which there is no specified symbol.
	Use to indicate prohibition when there is a risk of minor injury from electrical shock or other source if the product is disassembled.

CAUTION

Risk of a mild burn on rare occasions. Do not touch the device unit while it is powered on or immediately after the power is turned off.



The ignition may accidentally be caused. Tighten terminal screws to a specified torque 4.43 to 5.31 lb-in (0.5 to 0.6 N-m).



Minor electric shock, fire, or Product failure may occasionally occur. Do not allow any pieces of metal or conductors or any clippings or cuttings resulting from installation work to enter the Product.



Risk of product damage. Do not reverse the polarity of the device input terminals when wiring.



Risk of internal component deterioration and damage. Do not connect an AC power supply.



Minor electric shock, fire, or Product failure may occasionally occur. Do not disassemble, modify, or repair the Product or touch the interior of the Product.



Precautions for Safe Use

Wiring

- Minor fire may possibly occur. Ensure that input and output terminals are wired correctly.
- Increases in the temperature of internal parts resulting from heating of wiring materials may result in deterioration or damage to parts. Use wiring materials suitable to the current being used. The following wiring materials, torque and strip length are recommended to prevent heating and possible fires in wiring materials.

Terminal	Model	Recommend Wire Type		
		AWG	Solid wire	Twisted wire
Input	S8VK-R10	AWG14 to 12	2.5 to 4 mm ²	2.5 mm ²
	S8VK-R20	AWG12 to 10	4 to 6 mm ²	4 mm ²
Output	S8VK-R10	AWG14 to 12	2.5 to 4 mm ²	2.5 mm ²
	S8VK-R20	AWG12 to 10	4 to 6 mm ²	4 mm ²
Status contact	S8VK-R□□	AWG16	1.5 mm ²	---
All terminals	wires to be stripped: 8 mm			

- On rare occasions there is a risk of internal element deterioration and damage if use is continued in a short-circuit or over-current state.
- Do not apply more than 75N force to the terminal block when tightening it.
- Use within a range that does not exceed the output current rating. When a load short-circuit occurs, the short-circuit current of two power supply units flows. Use output wiring that can handle the short-circuit current of two units. If the wiring does not have sufficient current capacity, connect a fuse on the output side. Recommended fuse S8VK-R10: 15 A, S8VK-R20: 30 A Fast-acting type
- If the current rating of the output terminal is exceeded on the S8VK-R20, always use multiple terminals simultaneously.
- Risk of damage to internal components. Do not use in a state that exceeds the rated current of the signal output.

Installation Environment

- Do not use the Redundancy Unit in locations subject to shocks or vibrations. In particular, install the Redundancy Unit as far away as possible from contactors or other devices that are a vibration source.
- Install the Redundancy Unit well away from any sources of strong, high-frequency noise and surge.

Ambient Operating and Storage Environments

- Store the product with ambient temperature -40 to 85°C, and relative humidity 0 to 95%.
- The internal parts may occasionally be deteriorated or broken. Do not use at a temperature that exceed the operating temperature range for the mounting type.
- Use the product where the relative humidity is 0 to 95%.
- Avoid places where the product is subjected to direct sunlight.
- Avoid places where the product is subjected to penetration of liquid, foreign substance, or corrosive gas.
- Avoid places subject to shock or vibration. A device such as a contact breaker may be a vibration source.
- Set the Redundancy Unit as far as possible from possible sources of shock or vibration.
- If the Redundancy Unit is used in an area with excessive electronic noise or surge, be sure to separate the Redundancy Unit as far as possible from the noise sources.

Precautions for Correct Use

Mounting

The long-term reliability of the S8VK-R can be increased by installing it properly and sufficiently considering heat dissipation.

Install the S8VK-R so that the air flow circulates around it, because the S8VK-R is designed to radiate heat by means of natural air circulation.

Can be used in a contact mounting with the S8VK-G (not covered by safety certification). Two S8VK-G units cannot be mounted together in a contact mounting.

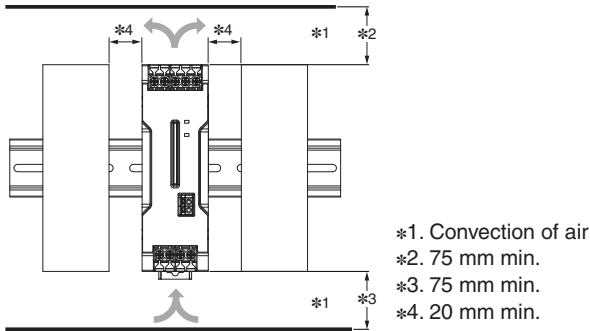

Input Voltage

Rating

S8VK-R10: DC5 to 30V

S8VK-R20: DC10 to 60V

Input Power Supply Selection

This product contains an internal fuse. If a power supply other than the S8VK-G is used, the fuse may blow, depending on the state of the load. Do not connect a power supply other than the S8VK-G to this product.

If you are building a redundant system, never use in a state that exceeds the rated current of the power supply. If one of the power supplies goes down, there is a risk that the voltage on the load side cannot be attained.

Use the same model for the power supplies that are connected.

On rare occasions internal element deterioration and damage may occur if use is continued in a short-circuit or over-current state. Do not continue use for more than 10 seconds.

Do not use in applications where load rush current or overload may frequently occur. Slight risk of deterioration and damage due to internal loss.

The signal output / status LED may occasionally not operate stably.

When using in environments where the temperature is less than -25°C , always adjust the 5 V power supply to 5.3 V or higher.

Dielectric Strength Test

The S8VK-R is designed to withstand a voltage test of 1 kV AC between all input/output terminals and the chassis, and 0.5 kV AC between all input/output terminals and the signal output terminal, for one minute.

Note:

1. The S8VK-R may possibly be damaged from the impulse voltage if a testing device switch is used to abruptly apply or shut off 1 kV AC, 0.5 kV AC. Increase the applied voltage gradually using the voltage adjustment on the testing device.
2. When testing, always short-circuit all terminals to prevent damage to the output terminal.

Signal output

Photo switch output

Photo switch ON when input voltage difference is 2.4 V typ. or less. 30 VDC max. (LVLC), 50 mA max., residual voltage when ON: 2 V max., leakage current when OFF: 0.1 mA max.

Status display LEDs

The status display LEDs show the status of the input power as shown in the table below.

Redundancy OK

Green on: Input voltage difference is 2.4 V typ. or less.

Voltage balance

Green on: Input voltage difference is 50 mV typ. or less.

The redundancy OK display/signal operates when the voltage difference is no more than 2.4 V typ. When using a 5 V or 12 V power supply, verify that there is no difference in the output voltages of the power supplies.

The voltage balance display does not guarantee current balance. The degree of balance varies by model, and therefore if you require operation with balanced current, check the output current of each power supply unit.

The models below use a voltage balance display, and cannot be used as a current balance.

S8VK-G015□□

S8VK-G03012·S8VK-G03024

S8VK-G06024

When adjusting the voltage based on the voltage balance, adjust the voltage of only one power supply. If you must adjust the voltages of both power supplies, be sure to check the output voltage before use. If you want to use the voltage balance display to ensure that the expected life is obtained, use the same thickness and length of wiring from each S8VK-G to the S8VK-R.

Connections

It is possible to connect S8VK-R like below.

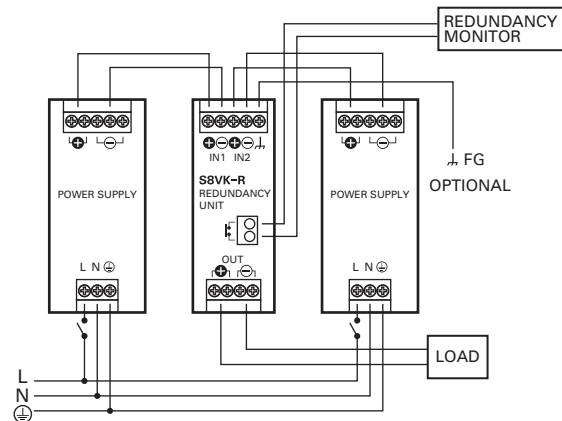

Terms and Conditions of Sale

1. **Offer; Acceptance.** These terms and conditions (these "**Terms**") are deemed part of all quotes, agreements, purchase orders, acknowledgments, price lists, catalogs, manuals, brochures and other documents, whether electronic or in writing, relating to the sale of products or services (collectively, the "**Products**") by Omron Electronics LLC and its subsidiary companies ("**Omron**"). Omron objects to any terms or conditions proposed in Buyer's purchase order or other documents which are inconsistent with, or in addition to, these Terms.
2. **Prices; Payment Terms.** All prices stated are current, subject to change without notice by Omron. Omron reserves the right to increase or decrease prices on any unshipped portions of outstanding orders. Payments for Products are due net 30 days unless otherwise stated in the invoice.
3. **Discounts.** Cash discounts, if any, will apply only on the net amount of invoices sent to Buyer after deducting transportation charges, taxes and duties, and will be allowed only if (i) the invoice is paid according to Omron's payment terms and (ii) Buyer has no past due amounts.
4. **Interest.** Omron, at its option, may charge Buyer 1-1/2% interest per month or the maximum legal rate, whichever is less, on any balance not paid within the stated terms.
5. **Orders.** Omron will accept no order less than \$200 net billing.
6. **Governmental Approvals.** Buyer shall be responsible for, and shall bear all costs involved in, obtaining any government approvals required for the importation or sale of the Products.
7. **Taxes.** All taxes, duties and other governmental charges (other than general real property and income taxes), including any interest or penalties thereon, imposed directly or indirectly on Omron or required to be collected directly or indirectly by Omron for the manufacture, production, sale, delivery, importation, consumption or use of the Products sold hereunder (including customs duties and sales, excise, use, turnover and license taxes) shall be charged to and remitted by Buyer to Omron.
8. **Financial.** If the financial position of Buyer at any time becomes unsatisfactory to Omron, Omron reserves the right to stop shipments or require satisfactory security or payment in advance. If Buyer fails to make payment or otherwise comply with these Terms or any related agreement, Omron may (without liability and in addition to other remedies) cancel any unshipped portion of Products sold hereunder and stop any Products in transit until Buyer pays all amounts, including amounts payable hereunder, whether or not then due, which are owing to it by Buyer. Buyer shall in any event remain liable for all unpaid accounts.
9. **Cancellation; Etc.** Orders are not subject to rescheduling or cancellation unless Buyer indemnifies Omron against all related costs or expenses.
10. **Force Majeure.** Omron shall not be liable for any delay or failure in delivery resulting from causes beyond its control, including earthquakes, fires, floods, strikes or other labor disputes, shortage of labor or materials, accidents to machinery, acts of sabotage, riots, delay in or lack of transportation or the requirements of any government authority.
11. **Shipping; Delivery.** Unless otherwise expressly agreed in writing by Omron:
 - a. Shipments shall be by a carrier selected by Omron; Omron will not drop ship except in "break down" situations.
 - b. Such carrier shall act as the agent of Buyer and delivery to such carrier shall constitute delivery to Buyer;
 - c. All sales and shipments of Products shall be FOB shipping point (unless otherwise stated in writing by Omron), at which point title and risk of loss shall pass from Omron to Buyer; provided that Omron shall retain a security interest in the Products until the full purchase price is paid;
 - d. Delivery and shipping dates are estimates only; and
 - e. Omron will package Products as it deems proper for protection against normal handling and extra charges apply to special conditions.
12. **Claims.** Any claim by Buyer against Omron for shortage or damage to the Products occurring before delivery to the carrier must be presented in writing to Omron within 30 days of receipt of shipment and include the original transportation bill signed by the carrier noting that the carrier received the Products from Omron in the condition claimed.
13. **Warranties.** (a) **Exclusive Warranty.** Omron's exclusive warranty is that the Products will be free from defects in materials and workmanship for a period of twelve months from the date of sale by Omron (or such other period expressed in writing by Omron). Omron disclaims all other warranties, express or implied. (b) **Limitations.** OMRON MAKES NO WARRANTY OR REPRESENTATION, EXPRESS OR IMPLIED, ABOUT NON-INFRINGEMENT, MERCHANTABILITY OR FITNESS FOR A PARTICULAR PURPOSE OF THE PRODUCTS. BUYER ACKNOWLEDGES THAT IT ALONE HAS DETERMINED THAT THE PRODUCTS WILL SUITABLY MEET THE REQUIREMENTS OF THEIR INTENDED USE. Omron further disclaims all warranties and responsibility of any type for claims or expenses based on infringement by the Products or otherwise of any intellectual property right. (c) **Buyer Remedy.** Omron's sole obligation hereunder shall be, at Omron's election, to (i) replace (in the form originally shipped with Buyer responsible for labor charges for removal or replacement thereof) the non-complying Product, (ii) repair the non-complying Product, or (iii) repay or credit Buyer an amount equal to the purchase price of the non-complying Product; provided that in no event shall Omron be responsible for warranty, repair, indemnity or any other claims or expenses regarding the Products unless Omron's analysis confirms that the Products were properly handled, stored, installed and maintained and not subject to contamination, abuse, misuse or inappropriate modification. Return of any Products by Buyer must be approved in writing by Omron before shipment. Omron Companies shall not be liable for the suitability or unsuitability or the results from the use of Products in combination with any electrical or electronic components, circuits, system assemblies or any other materials or substances or environments. Any advice, recommendations or information given orally or in writing, are not to be construed as an amendment or addition to the above warranty. See <http://www.omron247.com> or contact your Omron representative for published information.
14. **Limitation on Liability; Etc.** OMRON COMPANIES SHALL NOT BE LIABLE FOR SPECIAL, INDIRECT, INCIDENTAL, OR CONSEQUENTIAL DAMAGES, LOSS OF PROFITS OR PRODUCTION OR COMMERCIAL LOSS IN ANY WAY CONNECTED WITH THE PRODUCTS, WHETHER SUCH CLAIM IS BASED IN CONTRACT, WARRANTY, NEGLIGENCE OR STRICT LIABILITY. Further, in no event shall liability of Omron Companies exceed the individual price of the Product on which liability is asserted.
15. **Indemnities.** Buyer shall indemnify and hold harmless Omron Companies and their employees from and against all liabilities, losses, claims, costs and expenses (including attorney's fees and expenses) related to any claim, investigation, litigation or proceeding (whether or not Omron is a party) which arises or is alleged to arise from Buyer's acts or omissions under these Terms or in any way with respect to the Products. Without limiting the foregoing, Buyer (at its own expense) shall indemnify and hold harmless Omron and defend or settle any action brought against such Companies to the extent based on a claim that any Product made to Buyer specifications infringed intellectual property rights of another party.
16. **Property; Confidentiality.** Any intellectual property in the Products is the exclusive property of Omron Companies and Buyer shall not attempt to duplicate it in any way without the written permission of Omron. Notwithstanding any charges to Buyer for engineering or tooling, all engineering and tooling shall remain the exclusive property of Omron. All information and materials supplied by Omron to Buyer relating to the Products are confidential and proprietary, and Buyer shall limit distribution thereof to its trusted employees and strictly prevent disclosure to any third party.
17. **Export Controls.** Buyer shall comply with all applicable laws, regulations and licenses regarding (i) export of products or information; (iii) sale of products to "forbidden" or other proscribed persons; and (ii) disclosure to non-citizens of regulated technology or information.
18. **Miscellaneous.** (a) **Waiver.** No failure or delay by Omron in exercising any right and no course of dealing between Buyer and Omron shall operate as a waiver of rights by Omron. (b) **Assignment.** Buyer may not assign its rights hereunder without Omron's written consent. (c) **Law.** These Terms are governed by the law of the jurisdiction of the home office of the Omron company from which Buyer is purchasing the Products (without regard to conflict of law principles). (d) **Amendment.** These Terms constitute the entire agreement between Buyer and Omron relating to the Products, and no provision may be changed or waived unless in writing signed by the parties. (e) **Severability.** If any provision hereof is rendered ineffective or invalid, such provision shall not invalidate any other provision. (f) **Setoff.** Buyer shall have no right to set off any amounts against the amount owing in respect of this invoice. (g) **Definitions.** As used herein, "including" means "including without limitation"; and "Omron Companies" (or similar words) mean Omron Corporation and any direct or indirect subsidiary or affiliate thereof.

Certain Precautions on Specifications and Use

1. **Suitability of Use.** Omron Companies shall not be responsible for conformity with any standards, codes or regulations which apply to the combination of the Product in the Buyer's application or use of the Product. At Buyer's request, Omron will provide applicable third party certification documents identifying ratings and limitations of use which apply to the Product. This information by itself is not sufficient for a complete determination of the suitability of the Product in combination with the end product, machine, system, or other application or use. Buyer shall be solely responsible for determining appropriateness of the particular Product with respect to Buyer's application, product or system. Buyer shall take application responsibility in all cases but the following is a non-exhaustive list of applications for which particular attention must be given: (i) Outdoor use, uses involving potential chemical contamination or electrical interference, or conditions or uses not described in this document. (ii) Use in consumer products or any use in significant quantities. (iii) Energy control systems, combustion systems, railroad systems, aviation systems, medical equipment, amusement machines, vehicles, safety equipment, and installations subject to separate industry or government regulations. (iv) Systems, machines and equipment that could present a risk to life or property. Please know and observe all prohibitions of use applicable to this Product. NEVER USE THE PRODUCT FOR AN APPLICATION INVOLVING SERIOUS RISK TO LIFE OR PROPERTY OR IN LARGE QUANTITIES WITHOUT ENSURING THAT THE SYSTEM AS A WHOLE HAS BEEN DESIGNED TO ADDRESS THE RISKS, AND THAT THE OMRON'S PRODUCT IS PROPERLY RATED AND INSTALLED FOR THE INTENDED USE WITHIN THE OVERALL EQUIPMENT OR SYSTEM.
2. **Programmable Products.** Omron Companies shall not be responsible for the user's programming of a programmable Product, or any consequence thereof.
3. **Performance Data.** Data presented in Omron Company websites, catalogs and other materials is provided as a guide for the user in determining suitability and does not constitute a warranty. It may represent the result of Omron's test conditions, and the user must correlate it to actual application requirements. Actual performance is subject to the Omron's Warranty and Limitations of Liability.
4. **Change in Specifications.** Product specifications and accessories may be changed at any time based on improvements and other reasons. It is our practice to change part numbers when published ratings or features are changed, or when significant construction changes are made. However, some specifications of the Product may be changed without any notice. When in doubt, special part numbers may be assigned to fix or establish key specifications for your application. Please consult with your Omron's representative at any time to confirm actual specifications of purchased Product.
5. **Errors and Omissions.** Information presented by Omron Companies has been checked and is believed to be accurate; however, no responsibility is assumed for clerical, typographical or proofreading errors or omissions.

OMRON INDUSTRIAL AUTOMATION • THE AMERICAS HEADQUARTERS

Schaumburg, IL USA • 847.843.7900 • 800.556.6766 • www.omron247.com

OMRON CANADA, INC. • HEAD OFFICE

Toronto, ON, Canada • 416.286.6465 • 866.986.6766 • www.omron247.com

OMRON ELECTRONICS DE MEXICO • HEAD OFFICE

México DF • 52.55.59.01.43.00 • 001.800.556.6766 • mela@omron.com

OMRON ELECTRONICS DE MEXICO • SALES OFFICE

Apodaca, N.L. • 52.81.11.56.99.20 • 001.800.556.6766 • mela@omron.com

OMRON ELETRÔNICA DO BRASIL LTDA • HEAD OFFICE

São Paulo, SP, Brasil • 55.11.2101.6300 • www.omron.com.br

OMRON ARGENTINA • SALES OFFICE

Cono Sur • 54.11.4783.5300

OMRON CHILE • SALES OFFICE

Santiago • 56.9.9917.3920

OTHER OMRON LATIN AMERICA SALES

54.11.4783.5300

OMRON EUROPE B.V. • Wegalaan 67-69, NL-2132 JD, Hoofddorp, The Netherlands. • Tel: +31 (0) 23 568 13 00

Fax: +31 (0) 23 568 13 88 • www.industrial.omron.eu