

REVISIONS		
REV	ECN	DATE
		MM/DD/YY

.866 [22]

.256 [6.5]

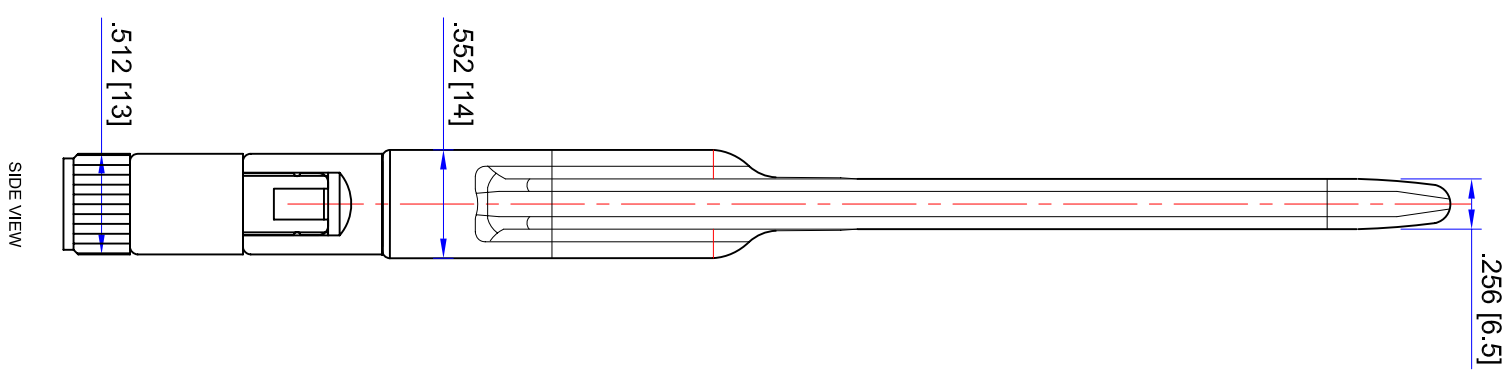
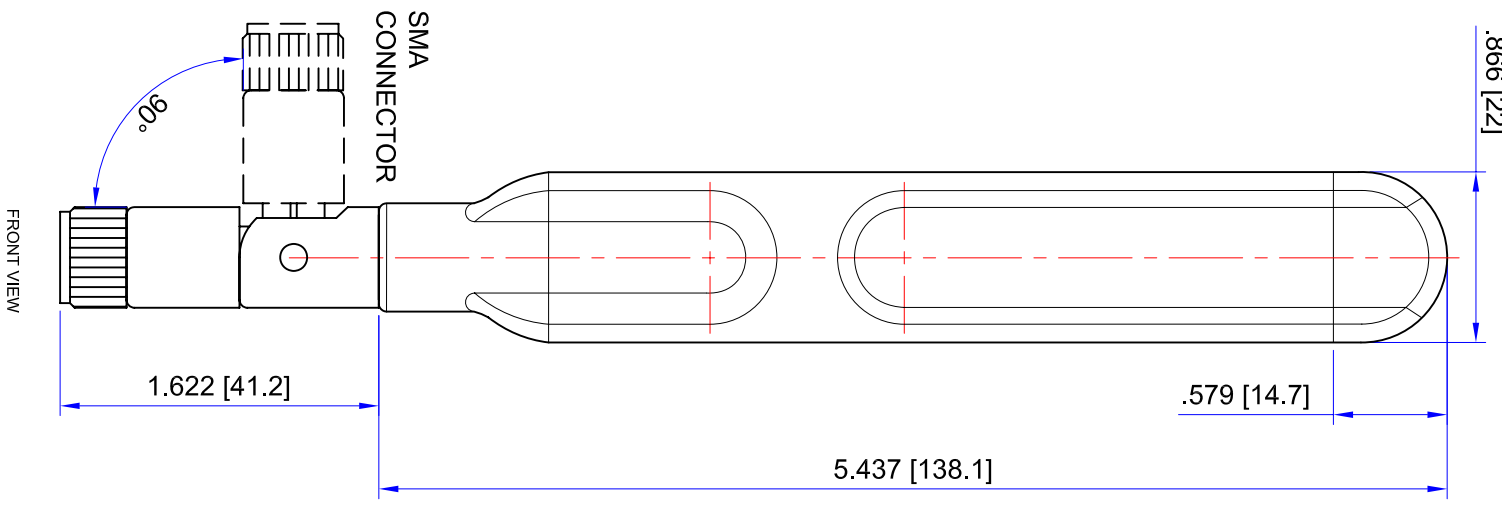

Electrical Properties:

- Frequency Range:**
 AMPS: 824-896MHz
 GSM: 890-960MHz
 PCS: 1850~1990MHz
 DCS: 1710~1880MHz
 UMTS: 1920~2170MHz
- Impedance:**
 50Ω nominal
- VSWR:**
 ADGP <2.0:1 ; UMTS <3.0:1
- Gain:**
 2dBi Typical
- Radiation:**
 Omni
- Polarization:**
 Vertical, Linear

Mechanical Properties:

- Connector:** SMA Type
- Material:** TPV Santoprene
- Radome Housing:** TPV Santoprene
- Mast:** Brass with Black Chrome Finish
- Connector:** SMA Plug Reverse Polarity
- Operation Temp.:** -20°C to +65°C
- Storage Temp.:** -30°C to +75°C
- This is a RoHS compliance product.**

Series Part Number

Connector Code	Description	P / N
AM	SMA Plug	T6150AM-AGDPU-S
AH	SMA Plug Reverse Polarity	T6150AH-AGDPU-S

TITLE	Multiple Band Swivel Antenna – 6150 model		DATE	11/06/07	SHEET	1 of 2
UNIT	mm		DWG. NO.	T6150XX-AGDPU-S		
SCALE	NONE					
NONE						

REVISIONS		
REV	ECN	DATE
		MM/DD/YY

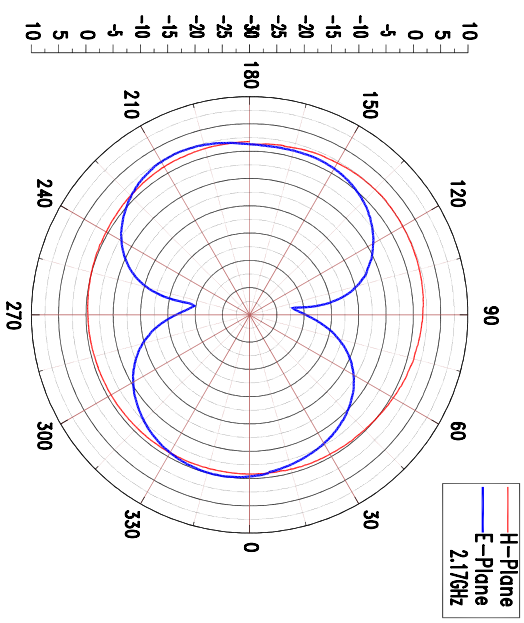
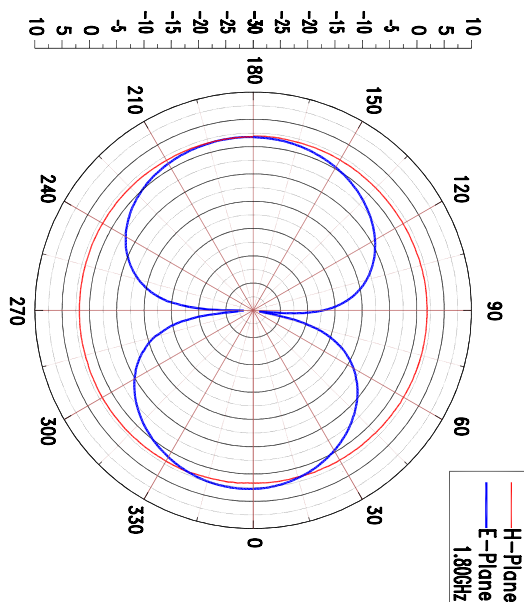
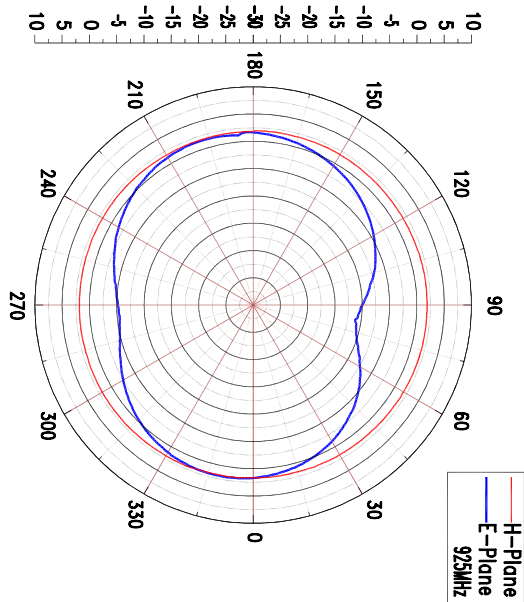
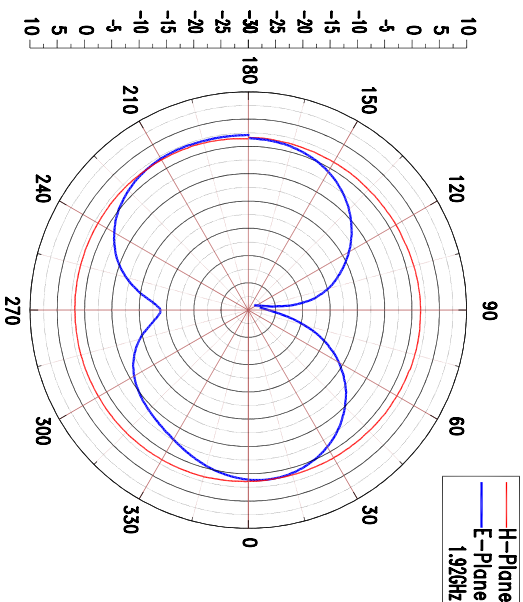
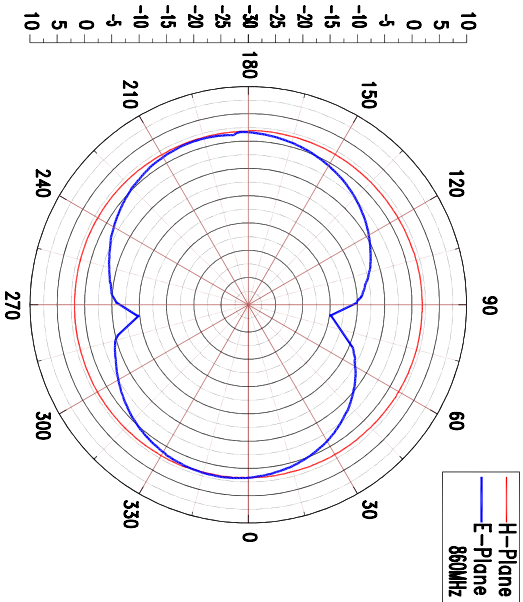

TITLE	Multiple Band Swivel Antenna — 6150 model		DATE	11/06/07	SHEET	2 OF 2
UNIT	mm	DWG. NO.	T6150XX-AGDPU-S			
SCALE	NONE					

NEARSON