



Main

| | |
|------------------------------|---|
| Range of Product | Altistart 22 |
| Product or Component Type | Soft starter |
| Product destination | Asynchronous motors |
| Product Specific Application | Pumps and fans |
| Component name | ATS22 |
| Phase | 3 phase |
| [Us] rated supply voltage | 208...600 V - 15...10 % |
| Maximum Horse Power Rating | 150 Hp 208 V 350 Hp 460 V 400 hp 575 V |
| Factory setting current | 414 A |
| Power dissipation in W | 218 W for standard applications |
| Utilisation category | AC-53A |
| Type of start | Start with torque control (current limited to 3.5 In) |
| IcL starter rating | 480 A connection in the motor supply line for standard applications |
| IP Degree of Protection | IP00 |

Complementary

| | |
|------------------------------|--|
| Assembly style | With heat sink |
| Function Available | Internal bypass |
| Supply voltage limits | 177...660 V |
| Supply frequency | 50...60 Hz - 10...10 % |
| Network Frequency | 45...66 Hz |
| Device connection | In the motor supply line |
| [Uc] control circuit voltage | 110 V - 15...10 % 50/60 Hz |
| Control circuit consumption | 20 W |
| Discrete output number | 2 |
| Discrete output type | Relay outputs R1 230 V running, alarm, trip, stopped, not stopped, starting, ready C/O Relay outputs R2 230 V running, alarm, trip, stopped, not stopped, starting, ready C/O |
| Minimum switching current | 100 mA 12 V DC relay outputs) |
| Maximum switching current | 5 A 250 V AC resistive 1 relay outputs 5 A 30 V DC resistive 1 relay outputs 2 A 250 V AC inductive 0.4 20 ms relay outputs 2 A 30 V DC inductive 7 ms relay outputs |
| Discrete input number | 3 |
| Discrete input type | LI1, LI2, LI3) logic, 5 mA 20 kOhm |
| Discrete input voltage | 110 V <= 121 V |
| Discrete input logic | Positive logic LI1, LI2, LI3 < 20 V <= 15 mA > 79 V, <= 2 mA |
| Output current | 0.4...1 Icl adjustable |
| PTC probe input | 750 Ohm |
| Communication Port Protocol | Modbus |
| Connector type | 1 RJ45 |
| Communication data link | Serial |
| Physical interface | RS485 multidrop |

The information provided in this documentation contains general descriptions and/or technical characteristics of the performance of the products contained herein. This documentation is not intended as a substitute for and is not to be used for determining suitability or reliability of these products for specific user applications. It is the duty of any such user or integrator to perform the appropriate and complete risk analysis, evaluation and testing of the products with respect to the relevant specific application or use thereof. Neither Schneider Electric Industries SAS nor any of its affiliates or subsidiaries shall be responsible or liable for misuse of the information contained herein.

| | |
|--------------------|--|
| Transmission Rate | 4800, 9600 or 19200 bps |
| Installed device | 31 |
| Protection type | Phase failure line Thermal protection motor Thermal protection starter |
| Marking | CE |
| Type of cooling | Forced convection |
| Operating position | Vertical +/- 10 degree |
| Height | 17.91 in (455 mm) |
| Width | 11.97 in (304 mm) |
| Depth | 13.37 in (339.7 mm) |
| Net Weight | 110.23 lb(US) (50 kg) |

Environment

| | |
|---------------------------------------|--|
| Electromagnetic compatibility | Conducted and radiated emissions level A IEC 60947-4-2 Damped oscillating waves level 3 IEC 61000-4-12 Electrostatic discharge level 3 IEC 61000-4-2 Immunity to electrical transients level 4 IEC 61000-4-4 Immunity to radiated radio-electrical interference level 3 IEC 61000-4-3 Voltage/current impulse level 3 IEC 61000-4-5 |
| Standards | EN/IEC 60947-4-2 |
| Product Certifications | C-tick CCC UL CSA GOST |
| Vibration resistance | 1 gn 13...200 Hz)EN/IEC 60068-2-6 1.5 mm 2...13 Hz)EN/IEC 60068-2-6 |
| Shock resistance | 15 gn 11 ms EN/IEC 60068-2-27 |
| Noise level | 56 dB |
| Pollution degree | Level 2 IEC 60664-1 |
| Relative humidity | 0...95 % without condensation or dripping water EN/IEC 60068-2-3 |
| Ambient air temperature for operation | 14...104 °F (-10...40 °C) without derating) 104...140 °F (40...60 °C) with current derating 2.2 % per °C) |
| Ambient Air Temperature for Storage | -13...158 °F (-25...70 °C) |
| Operating altitude | <= 3280.84 ft (1000 m) without derating > 3280.84...< 6561.68 ft (> 1000...< 2000 m) with current derating of 2.2 % per additional 100 m |

Ordering and shipping details

| | |
|-----------------------|-------------------------|
| Category | 22576 - ATS22 ALTISTART |
| Discount Schedule | CP1G |
| GTIN | 3606480211232 |
| Nbr. of units in pkg. | 1 |
| Package weight(Lbs) | 86.53 lb(US) (39.25 kg) |
| Returnability | Yes |
| Country of origin | CN |

Packing Units

| | |
|------------------------------|--------------------------|
| Unit Type of Package 1 | PCE |
| Package 1 Height | 19.69 in (50 cm) |
| Package 1 width | 15.75 in (40 cm) |
| Package 1 Length | 23.62 in (60 cm) |
| Unit Type of Package 2 | PAL |
| Number of Units in Package 2 | 1 |
| Package 2 Weight | 87.00 lb(US) (39.463 kg) |
| Package 2 Height | 16.00 in (40.64 cm) |
| Package 2 width | 21.00 in (53.34 cm) |
| Package 2 Length | 23.00 in (58.42 cm) |

Offer Sustainability

| | |
|----------------------------|---|
| Sustainable offer status | Green Premium product |
| California proposition 65 | WARNING: This product can expose you to chemicals including: Lead and lead compounds, which is known to the State of California to cause cancer and birth defects or other reproductive harm. For more information go to www.P65Warnings.ca.gov |
| REACH Regulation | REACH Declaration |
| EU RoHS Directive | Pro-active compliance (Product out of EU RoHS legal scope) EU RoHS Declaration |
| Mercury free | Yes |
| RoHS exemption information | Yes |
| China RoHS Regulation | China RoHS Declaration |
| Environmental Disclosure | Product Environmental Profile |
| Circularity Profile | End Of Life Information |
| WEEE | The product must be disposed on European Union markets following specific waste collection and never end up in rubbish bins. |

Contractual warranty

| | |
|----------|-----------|
| Warranty | 18 months |
|----------|-----------|

Frame Size E

Dimensions

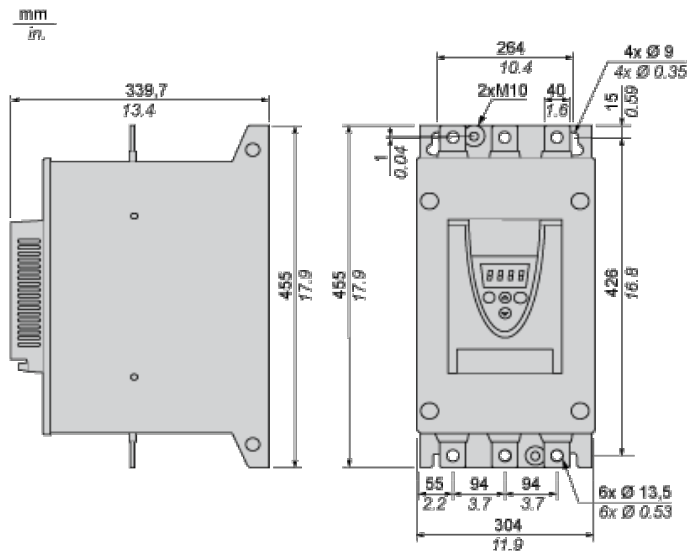

Precautions

Standards

The Altistart 22 soft starter is compliant with pollution Degree 2 as defined in NEMA ICS1-1 or IEC 60664-1.
For environment pollution degree 3, install the Altistart 22 soft starter inside a cabinet type 12 or IP54.

⚠ DANGER

HAZARD OF ELECTRIC SHOCK, EXPLOSION, OR ARC FLASH

ATS22 soft starters are open devices and must be mounted in a suitable enclosure.

Failure to follow these instructions will result in death or serious injury.

Air Circulation

Leave sufficient free space to help the air required for cooling purposes to circulate from the bottom to the top of the unit.

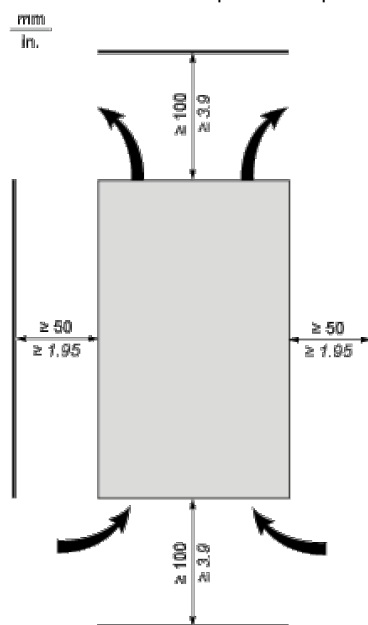

Overheating

To avoid the soft starter to overheat, respect the following recommendations:

- Mount the Altistart 22 Soft Starter within $\pm 10^\circ$ of vertical.
- Do not locate the Altistart 22 Soft Starter near heat radiating elements.
- Electrical current through the Altistart 22 Soft Starter will result in heat losses that must be dissipated into the ambient air immediately surrounding the soft starter. To help prevent a thermal fault, provide sufficient enclosure cooling and/or ventilation to limit the ambient temperature around the soft starter.
- If several soft starters are installed in a control panel, arrange them in a row. Do not stack soft starters. Heat generated from the bottom soft starter can adversely affect the ambient temperature around the top soft starter.

Wall mounted or Floor-standing Enclosure with IP 23 Degree of protection

Introduction

To help proper air circulation in the soft starter, grilles and forced ventilation can be installed.

Ventilation Grilles

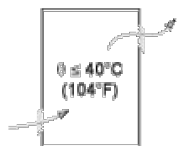

Forced Ventilation Unit

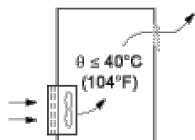

Power Terminal

Bar Style

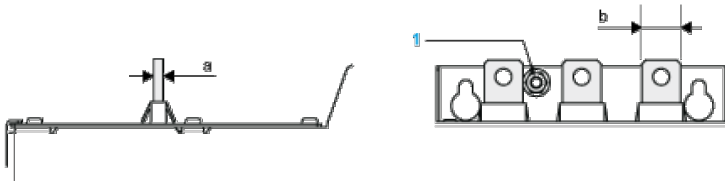

| | | | |
|----------------------------------|---------------|-----------------------|-----------------|
| Power supply and output to motor | Bar | b | 40 mm (1.18 in) |
| a | 5 mm (0.2 in) | | |
| Bolt | M12 (0.47 in) | | |
| Cable and protective cover | Size | 2X240 mm ² | |
| Gauge | 2X500 MCM | | |
| Protective cover | LA9F703 | | |
| Tightening torque | 57 N.m | | |
| 498.75 lb.in | | | |

Power connections, minimum required wiring section

| | |
|--|-------------------------------------|
| IEC cable mm ² (Cu 70°C/158°F) (1) | UL cable AWG (Cu 75°C/167°F) (1) |
| 2 X 150 | 3 X 350 MCM |

110 Vac control, Logic Inputs (LI) 110 Vac, 3-wire control

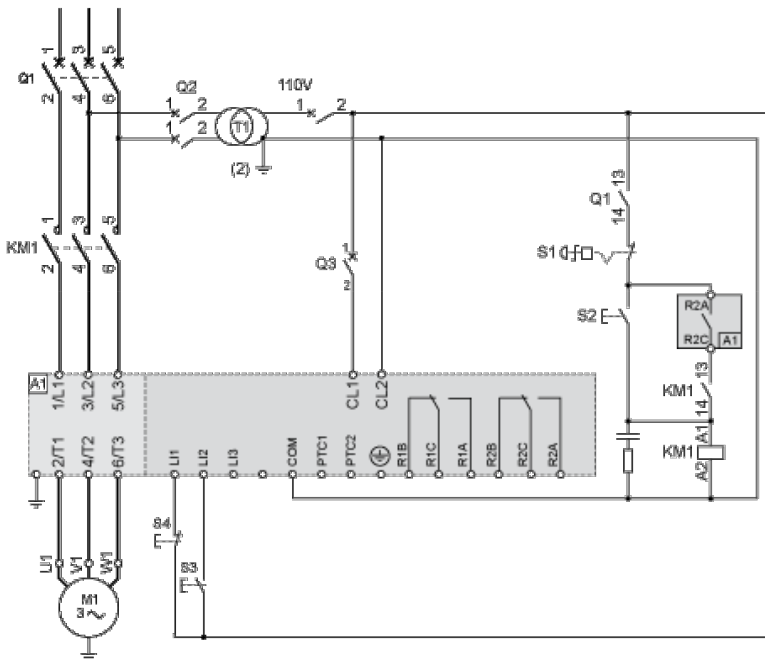

110 Vac control, Logic Inputs (LI) 110 Vac, 2-wire control, freewheelstop

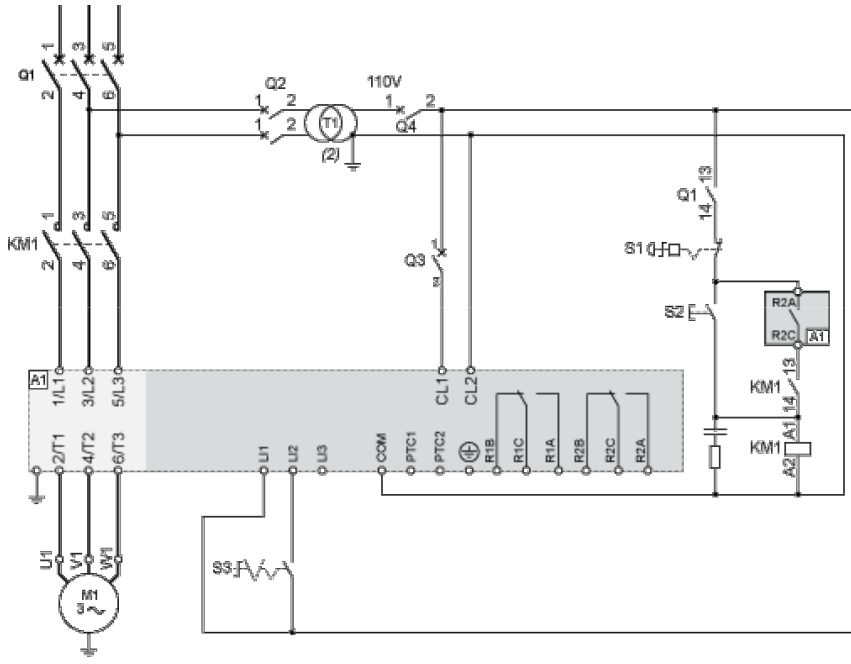

Motor Thermal Protection - Cold Curves

Curves

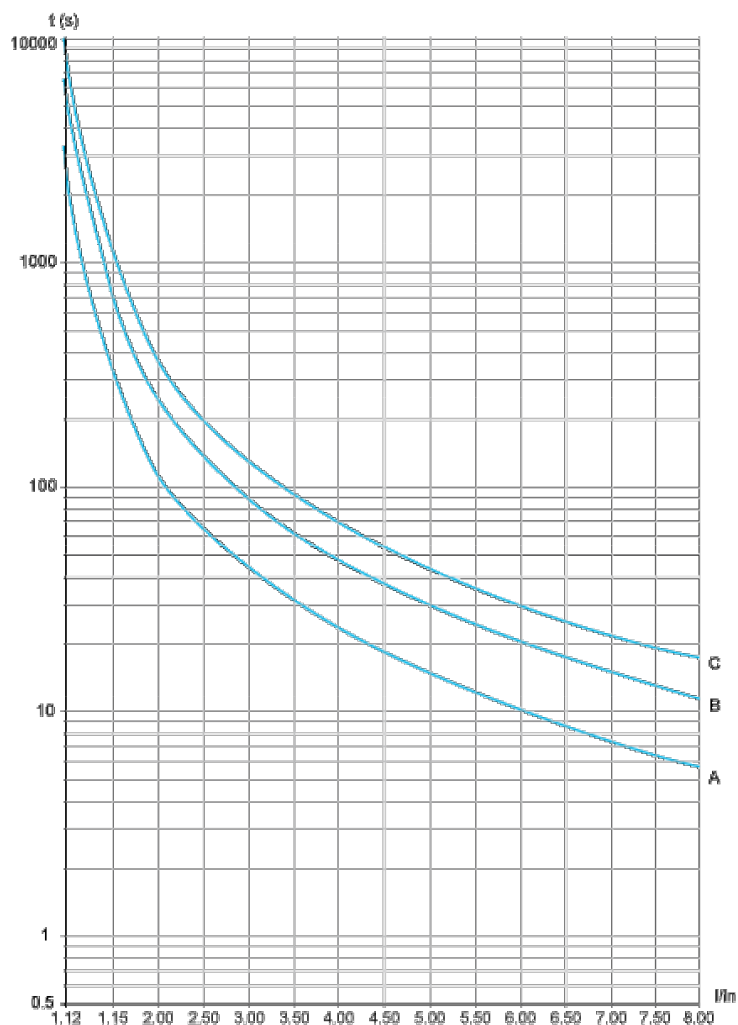

- A Class 10
- B Class 20
- C Class 30

Trip time for a Standard Application (Class 10)

| |
|--------|
| 3.5 In |
| 32 s |

Trip time for a Severe Application (Class 20)

| |
|--------|
| 3.5 In |
| 63 s |

Trip time for a Severe Application (Class 30)

| |
|--------|
| 3.5 In |
| 95 s |

Curves

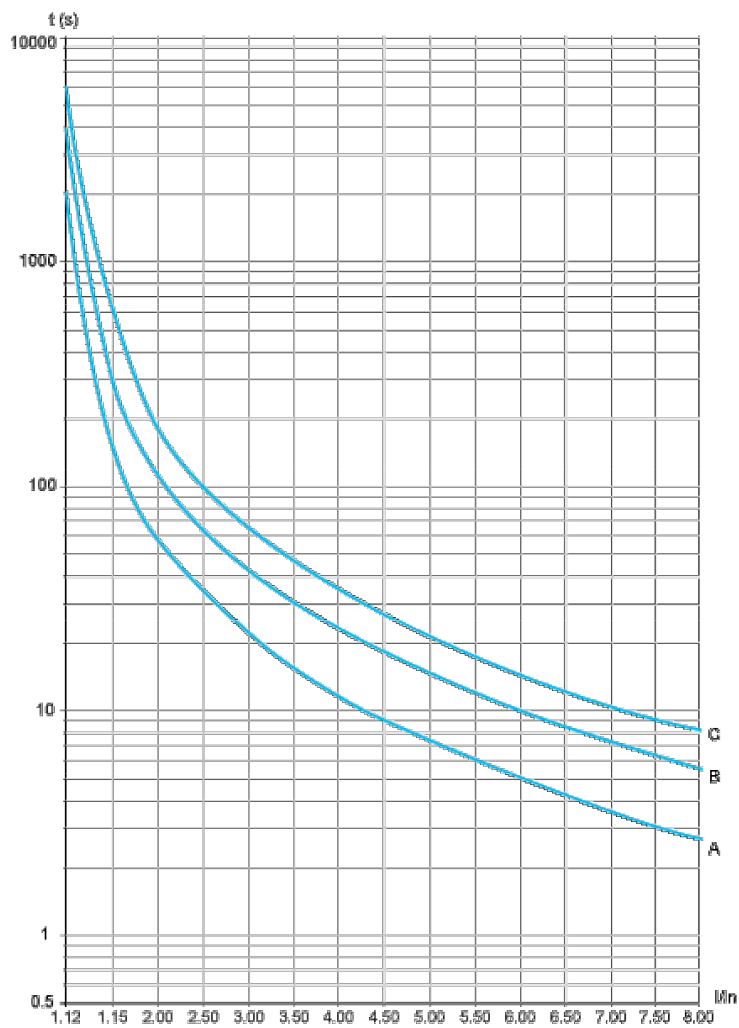

- A Class 10
- B Class 20
- C Class 30

Trip time for a Standard Application (Class 10)

| |
|--------|
| 3.5 In |
| 16 s |

Trip time for a Severe Application (Class 20)

| |
|--------|
| 3.5 In |
| 32 s |

Trip time for a Severe Application (Class 30)

| |
|--------|
| 3.5 In |
| 48 s |