



P-Channel 30-V (D-S) MOSFET with Schottky Diode

MOSFET PRODUCT SUMMARY		
V_{DS} (V)	$r_{DS(on)}$ (Ω)	I_D (A)
-30	0.045 @ $V_{GS} = -10$ V	± 5
	0.090 @ $V_{GS} = -4.5$ V	± 3.5

SCHOTTKY PRODUCT SUMMARY		
V_{KA} (V)	V_f (V) Diode Forward Voltage	I_F (A)
30	0.53 V @ 3 A	3

LITTLE FOOT Plus™

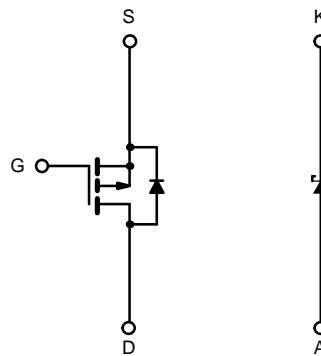
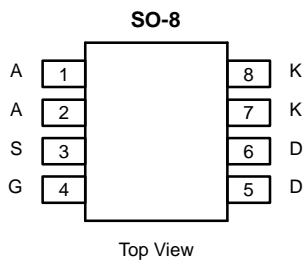

P-Channel MOSFET

ABSOLUTE MAXIMUM RATINGS ($T_A = 25^\circ\text{C}$ UNLESS OTHERWISE NOTED)				
Parameter		Symbol	Limit	Unit
Drain-Source Voltage (MOSFET)		V_{DS}	-30	V
Reverse Voltage (Schottky)		V_{KA}	30	
Gate-Source Voltage (MOSFET)		V_{GS}	± 20	
Continuous Drain Current ($T_J = 150^\circ\text{C}$) (MOSFET) ^{a, b}	$T_A = 25^\circ\text{C}$	I_D	± 5	A
	$T_A = 70^\circ\text{C}$		± 3.9	
Pulsed Drain Current (MOSFET)		I_{DM}	± 20	
Continuous Source Current (MOSFET Diode Conduction) ^{a, b}		I_S	-1.7	
Average Forward Current (Schottky)		I_F	3	
Pulsed Forward Current (Schottky)		I_{FM}	20	
Maximum Power Dissipation (MOSFET) ^{a, b}	$T_A = 25^\circ\text{C}$	P_D	2	W
	$T_A = 70^\circ\text{C}$		1.28	
Maximum Power Dissipation (Schottky) ^{a, b}	$T_A = 25^\circ\text{C}$		1.83	
	$T_A = 70^\circ\text{C}$		1.17	
Operating Junction and Storage Temperature Range		T_J, T_{stg}	-55 to 150	$^\circ\text{C}$

Notes

- a. Surface Mounted on FR4 Board.
- b. $t \leq 10$ sec.



THERMAL RESISTANCE RATINGS					
Parameter	Device	Symbol	Typical	Maximum	Unit
Maximum Junction-to-Ambient ($t \leq 10$ sec) ^a	MOSFET	R_{thJA}	52	62.5	°C/W
	Schottky		56	68	
Maximum Junction-to-Ambient ($t =$ steady state) ^a	MOSFET		82	100	
	Schottky		91	110	
Maximum Junction-to-Foot	MOSFET	R_{thJF}	27	33	
	Schottky		32	40	

Notes

- a. Surface Mounted on FR4 Board.
b. $t \leq 10$ sec.

MOSFET SPECIFICATIONS ($T_J = 25^\circ\text{C}$ UNLESS OTHERWISE NOTED)						
Parameter	Symbol	Test Condition	Min	Typ	Max	Unit
Static						
Gate Threshold Voltage	$V_{GS(th)}$	$V_{DS} = V_{GS}, I_D = -250 \mu\text{A}$	-1.0			V
Gate-Body Leakage	I_{GSS}	$V_{DS} = 0 \text{ V}, V_{GS} = \pm 20 \text{ V}$			± 100	nA
Zero Gate Voltage Drain Current	I_{DSS}	$V_{DS} = -24 \text{ V}, V_{GS} = 0 \text{ V}$			-1	μA
		$V_{DS} = -24 \text{ V}, V_{GS} = 0 \text{ V}, T_J = 75^\circ\text{C}$			-10	
On-State Drain Current ^a	$I_{D(on)}$	$V_{DS} \geq -5 \text{ V}, V_{GS} = -10 \text{ V}$	-20			A
Drain-Source On-State Resistance ^a	$r_{DS(on)}$	$V_{GS} = -10 \text{ V}, I_D = -5 \text{ A}$		0.036	0.045	Ω
		$V_{GS} = -4.5 \text{ V}, I_D = -3.5 \text{ A}$		0.060	0.090	
Forward Transconductance ^a	g_{fs}	$V_{DS} = -15 \text{ V}, I_D = -5 \text{ A}$		9		S
Diode Forward Voltage ^a	V_{SD}	$I_S = -1.7 \text{ A}, V_{GS} = 0 \text{ V}$		-0.75	-1.2	V
Dynamic^b						
Total Gate Charge	Q_g	$V_{DS} = -15 \text{ V}, V_{GS} = -5 \text{ V}, I_D = -5 \text{ A}$		10	20	nC
Gate-Source Charge	Q_{gs}		4.5			
Gate-Drain Charge	Q_{gd}		3.6			
Turn-On Delay Time	$t_{d(on)}$	$V_{DD} = -15 \text{ V}, R_L = 15 \Omega$ $I_D \cong -1 \text{ A}, V_{GEN} = -10 \text{ V}, R_G = 6 \Omega$		13	25	ns
Rise Time	t_r		15	30		
Turn-Off Delay Time	$t_{d(off)}$		37	70		
Fall Time	t_f		14	30		
Source-Drain Reverse Recovery Time	t_{rr}	$I_F = -1.7 \text{ A}, di/dt = 100 \text{ A}/\mu\text{s}$		35	70	

Notes

- a. Pulse test; pulse width $\leq 300 \mu\text{s}$, duty cycle $\leq 2\%$.
b. Guaranteed by design, not subject to production testing.

SCHOTTKY SPECIFICATIONS ($T_J = 25^\circ\text{C}$ UNLESS OTHERWISE NOTED)						
Parameter	Symbol	Test Condition	Min	Typ	Max	Unit
Forward Voltage Drop	V_F	$I_F = 3 \text{ A}$		0.485	0.53	V
		$I_F = 3 \text{ A}, T_J = 125^\circ\text{C}$		0.42	0.47	
Maximum Reverse Leakage Current	I_{rm}	$V_r = 30 \text{ V}$		0.008	0.1	mA
		$V_r = 30 \text{ V}, T_J = 75^\circ\text{C}$		0.4	5	
		$V_r = 30 \text{ V}, T_J = 125^\circ\text{C}$		6.5	20	
Junction Capacitance	C_T	$V_r = 15 \text{ V}$		102		pF



TYPICAL CHARACTERISTICS (25°C UNLESS NOTED) MOSFET

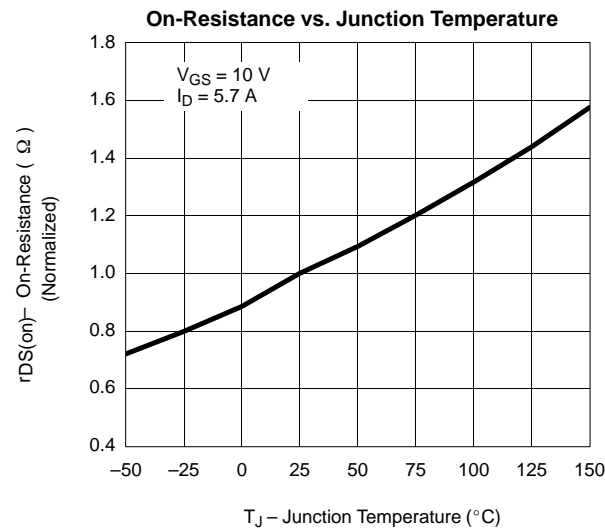
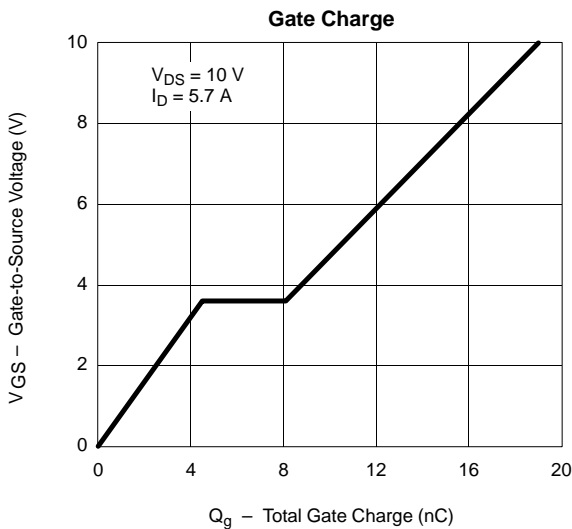
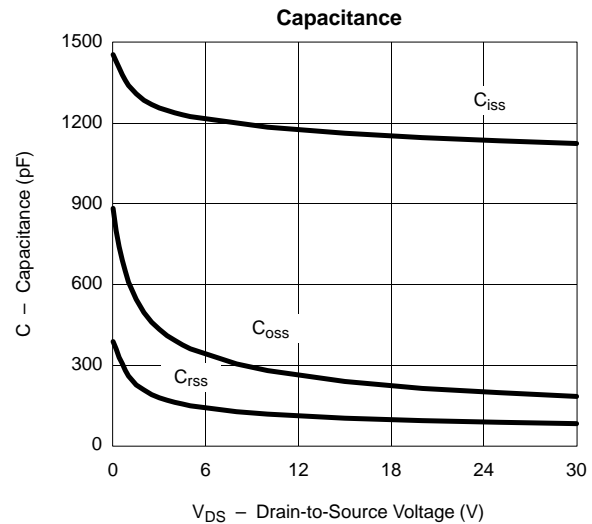
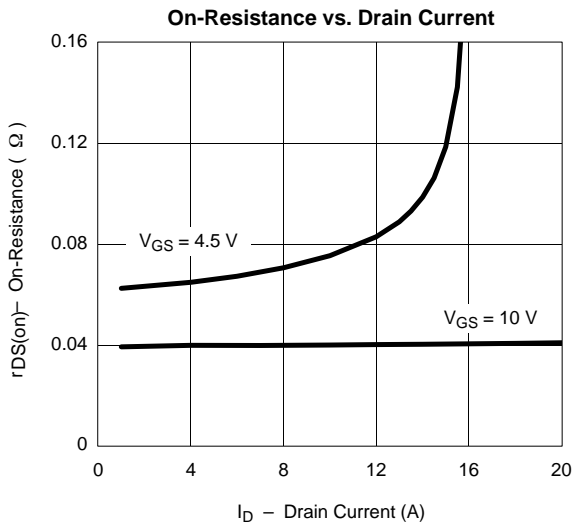
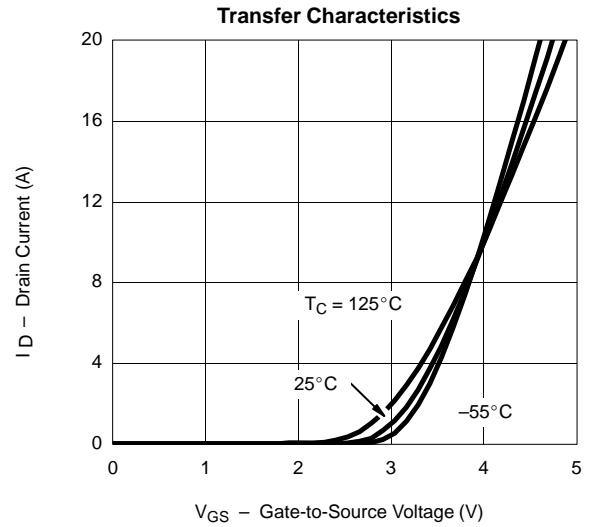
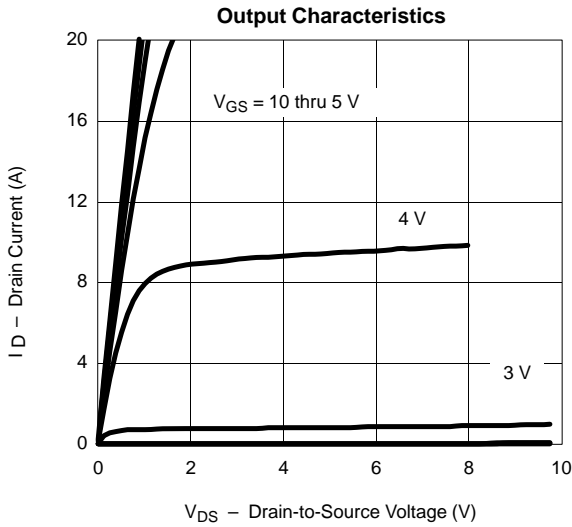



TYPICAL CHARACTERISTICS (25°C UNLESS NOTED) MOSFET

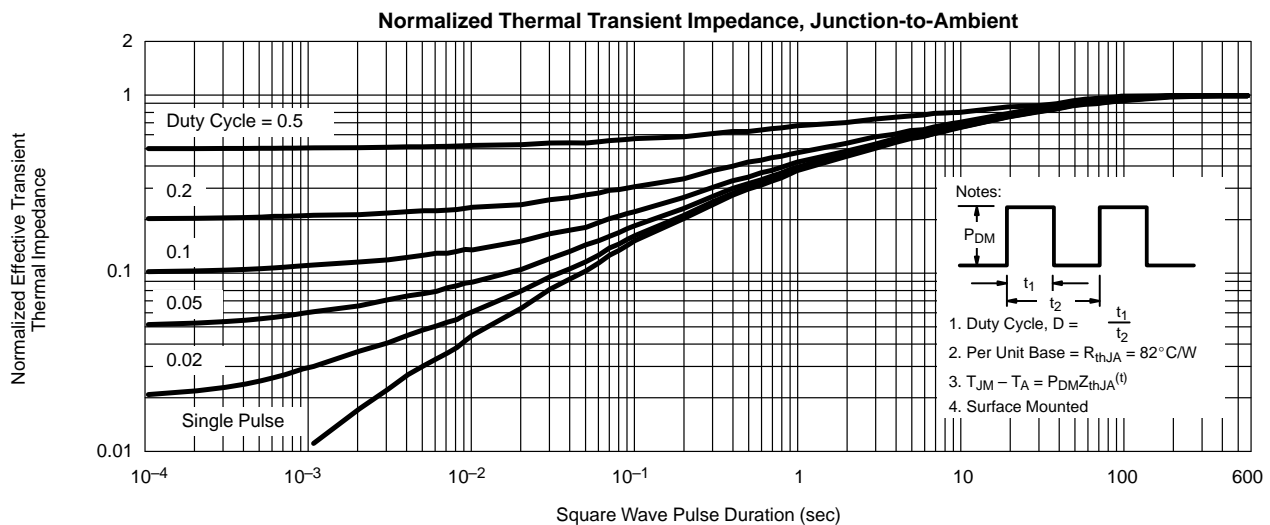
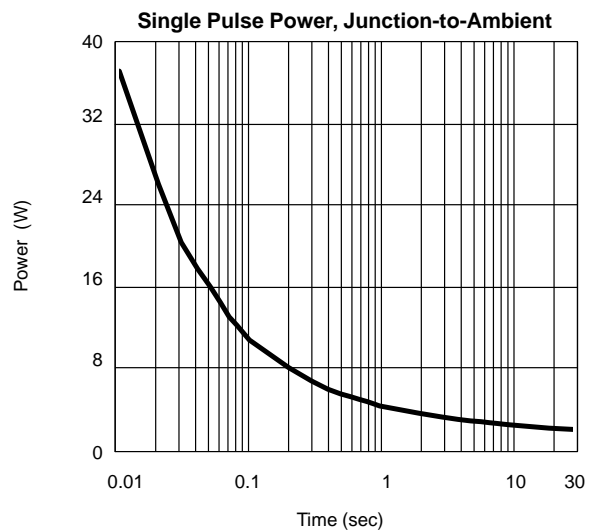
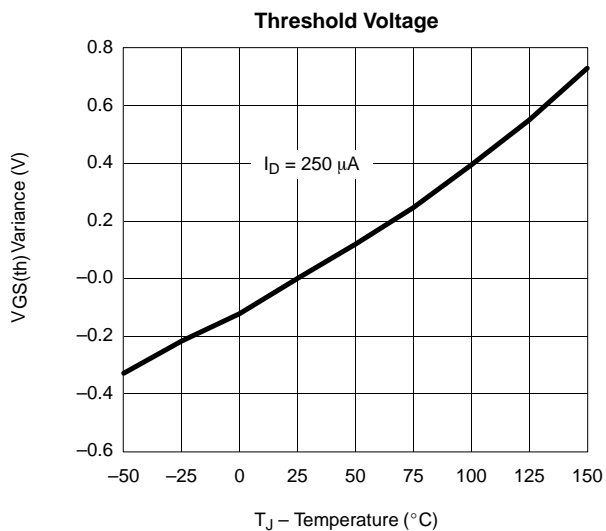
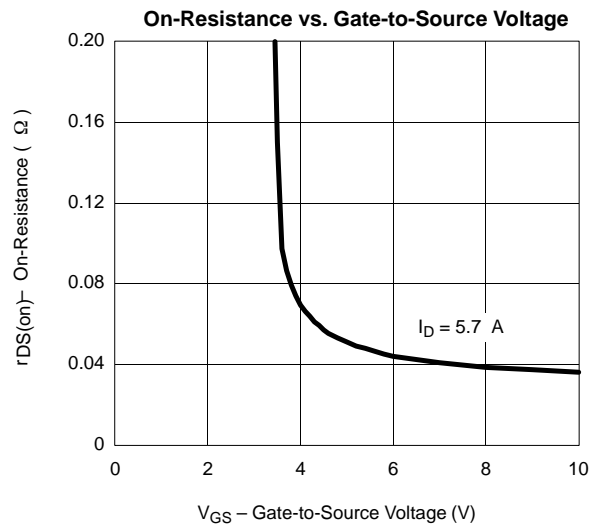
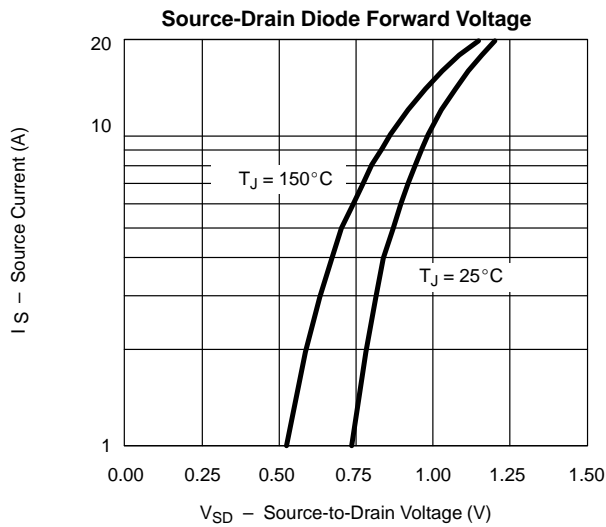



TYPICAL CHARACTERISTICS (25°C UNLESS NOTED) MOSFET

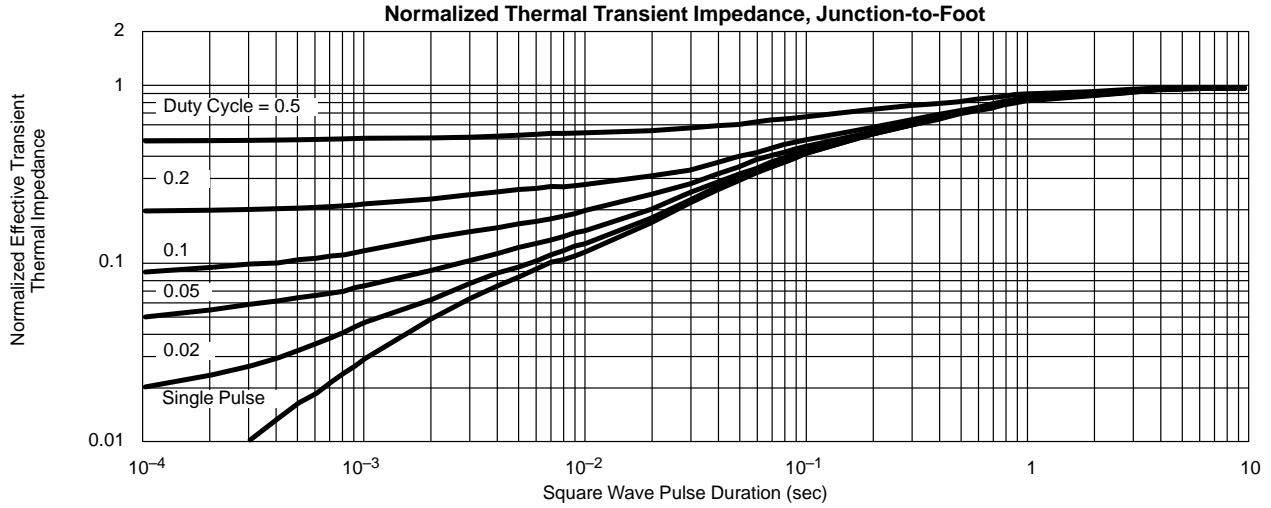

TYPICAL CHARACTERISTICS (25°C UNLESS NOTED) SCHOTTKY

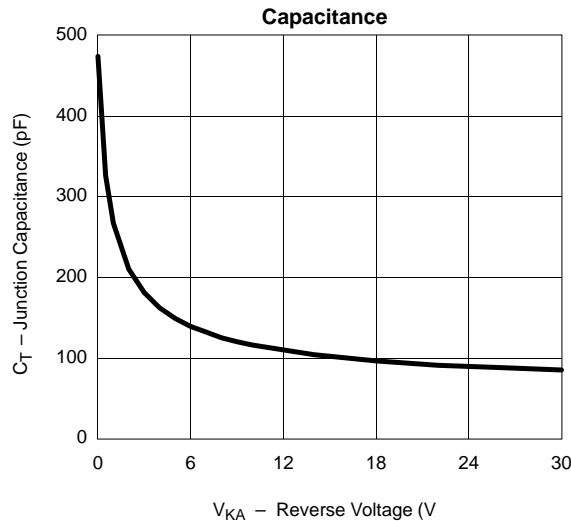
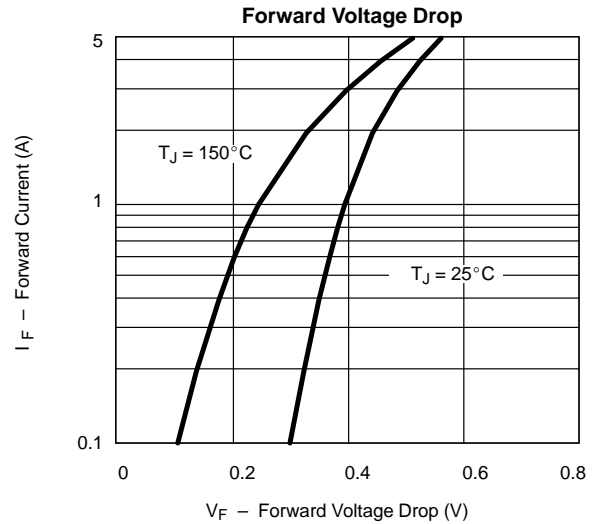
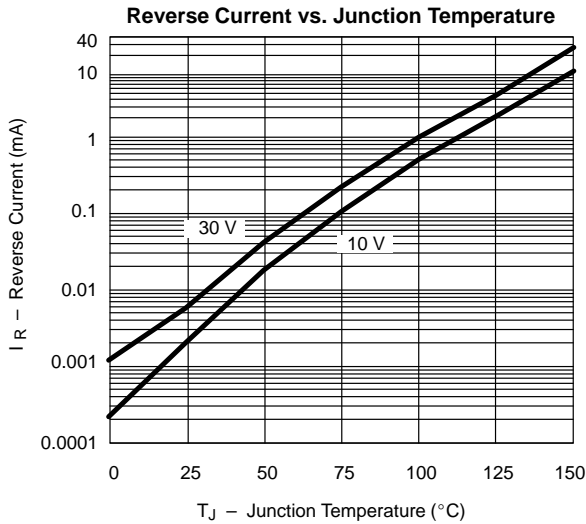



TYPICAL CHARACTERISTICS (25°C UNLESS NOTED)

SCHOTTKY

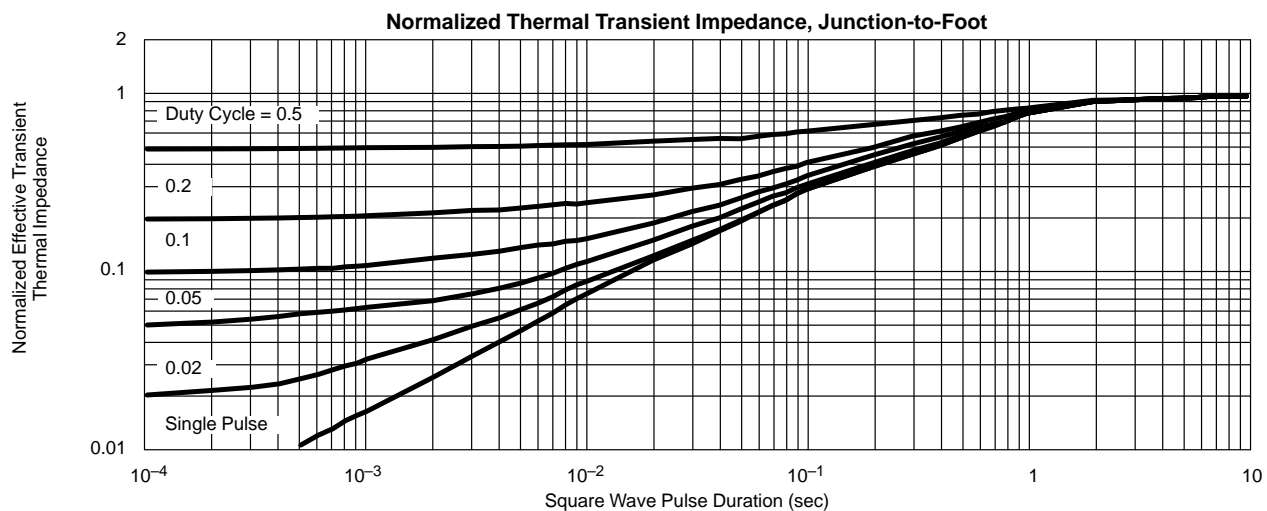
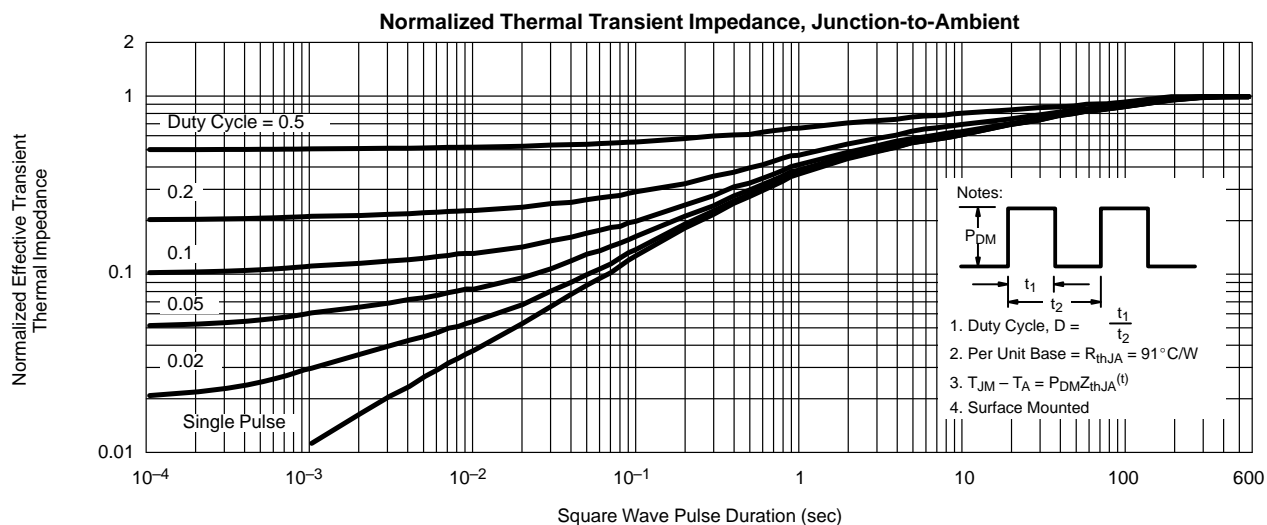



Disclaimer

All product specifications and data are subject to change without notice.

Vishay Intertechnology, Inc., its affiliates, agents, and employees, and all persons acting on its or their behalf (collectively, "Vishay"), disclaim any and all liability for any errors, inaccuracies or incompleteness contained herein or in any other disclosure relating to any product.

Vishay disclaims any and all liability arising out of the use or application of any product described herein or of any information provided herein to the maximum extent permitted by law. The product specifications do not expand or otherwise modify Vishay's terms and conditions of purchase, including but not limited to the warranty expressed therein, which apply to these products.

No license, express or implied, by estoppel or otherwise, to any intellectual property rights is granted by this document or by any conduct of Vishay.

The products shown herein are not designed for use in medical, life-saving, or life-sustaining applications unless otherwise expressly indicated. Customers using or selling Vishay products not expressly indicated for use in such applications do so entirely at their own risk and agree to fully indemnify Vishay for any damages arising or resulting from such use or sale. Please contact authorized Vishay personnel to obtain written terms and conditions regarding products designed for such applications.

Product names and markings noted herein may be trademarks of their respective owners.