

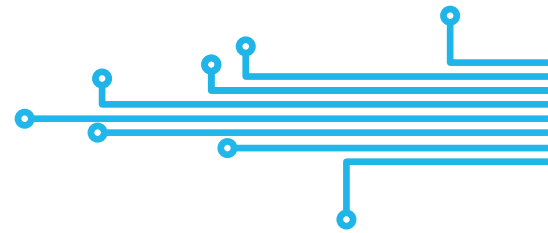

SGX

SENSORTECH

An Amphenol Company



PS1&PS4-VOC-10-MOD

Total Organic Volatile Module

Datasheet

Small size | Low cost | Long life | Fast response | High accuracy | Low power consumption



Quality, Safety, Responsibility

Product note

The PS1&PS4-VOC-10-MOD series TVOC gas module is the perfect combination of our sensor with an advanced printed circuit board. SGX Sensortech gas sensors are using a revolutionary 'Solid Polymer Electrolyte' technology that is based on the principle of catalytic reaction. The target gas to be measured generates a very small current, proportional to the gas concentration. Our technology offers a stable, high quality and cost-effective manufacturing process.

The module is equipped with a standard UART digital output, allowing operation by anyone without knowledge or understanding of the sensor application and the tedious work of calibration.

Features

- Sleeping function good for low power request IOT applications
- Combined with intelligent algorithms, it has stronger adaptability to the environment, more accurate detection, and stable zero point
- Good anti-toxicity, no consumption of chemical materials, more than 5 years Life time
- New micro circuit design, strong anti-electromagnetic interference ability
- Fast response, fast return to zero, plug and play
- Independent temperature and humidity digital sensor output
- The smallest size and lowest power consumption in the electrochemical field
- RoHS Eco-friendly design

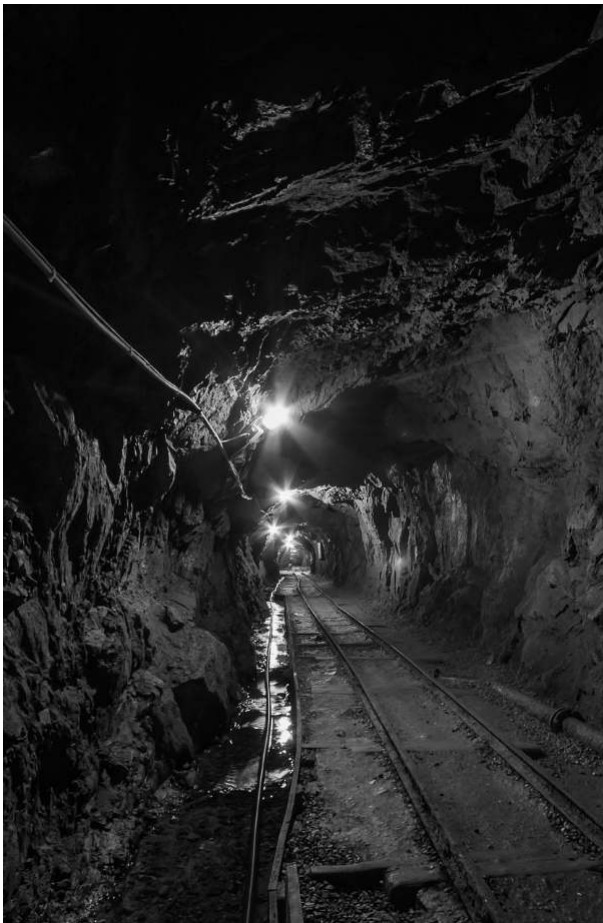
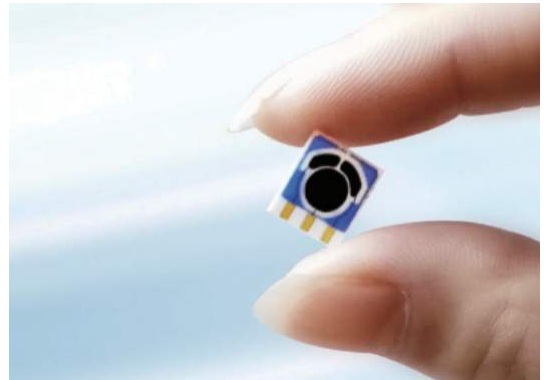

Application

- Commercial VOC emissions monitoring
- VOC monitoring of industrial exhaust emissions
- Monitoring of harmful gas released by home decoration materials
- Indoor and outdoor ambient air quality monitoring
- Air purification treatment efficiency monitoring
- Air quality monitoring of office buildings and public spaces
- VOCs monitoring of landfill and disposal environment
- Sewage treatment plant air quality monitoring
- VOC gas release from school plastic runway
- Monitoring of non-methane total hydrocarbons in rubber products workshop



Cross Sensitivity

Gas	Formula	Test Concentration	Sensor Reading
Acetic acid	CH ₃ COOH	5ppm	1.1ppm
Acetylene	C ₂ H ₂	/	Responded well
Acrylonitrile	C ₃ H ₃ N	/	Responded well
Ammonia	NH ₃	5ppm	1.5ppm
Benzene	C ₆ H ₆	5ppm	1.1ppm
Butadiene	C ₄ H ₆	/	Responded well
Carbon disulfide	CS ₂	5ppm	1.23ppm
DS-0423-PS1&PS4-VOC-10-MOD	CO	5ppm	3.38ppm
Dimethyl Disulfide	C ₂ H ₆ S ₂	2ppm	6.8ppm
Dining lampblack (dimensionless)	Unsaturated hydrocarbons	/	Responded well
Ethanol	C ₂ H ₆ O	5ppm	1.83ppm
Ethylene	C ₂ H ₄	5ppm	3.16ppm
Ethylene oxide	C ₂ H ₄ O	5ppm	3.83ppm
Formaldehyde	HCHO	5ppm	6ppm
Formic acid	HCOOH	5ppm	5.36ppm
Gasoline volatilization (dimensionless)	Aliphatic hydrocarbons, cycloalkanes, aromatic hydrocarbons	/	Responded well
Hydrogen	H ₂	5ppm	1.15ppm
Hydrogen chloride	HCl	5ppm	0.27ppm
Hydrogen cyanide	HCN	5ppm	0.36ppm
Isobutene	C ₄ H ₈	5ppm	5ppm
Methanol	CH ₃ OH	5ppm	5.95ppm
Methyl mercaptan	CH ₄ S	5ppm	7ppm
Methyl sulfide	C ₂ H ₆ S	5ppm	8.97ppm
Nitrogen dioxide	NO ₂	5ppm	1.86ppm
O-xylene	C ₈ H ₁₀	5ppm	0.58ppm
Styrene	C ₈ H ₈	0.5ppm	7.5ppm
Toluene	C ₇ H ₈	5ppm	0.81ppm
Trimethylamine	C ₃ H ₉ N	5ppm	0.65ppm

Note: 1) The above interference factors may be different due to different sensors and service life, please refer to the actual test results.
2) This table is not complete for all gases, and the sensor may be sensitive to other gases.

Order Informations

	Part Number	Range	Resolution
TVOC Gas Module	PS1-VOC-10-MOD	0-10ppm	0.01ppm
TVOC Gas Module	PS4-VOC-10-MOD	0-10ppm	0.01ppm
4Pin Cable	Module 4 PIN cable		

Specification

Principle	Solid Polymer Electrochemical Sensing Technology
Detection of gas	TVOC organic volatile gas
Detection Range	0-10ppm; Resolution: 0.01ppm
Lowest Detection Limit	0.05ppm
Full-scale accuracy error	± 5% F.S
Repeatability	<2%
Settling time	The first power-on under storage in clean air <120 seconds The first power-up under storage in non-clean air <240 seconds (except in the presence of high concentrations of polluted gas)
Response time	T90: <20 seconds
Zero return time	<80 seconds Note: The module is separated from the measured gas environment, in clean air, the displayed value returns to 0.03ppm or less
Calibration Gas	Isobutene standard gas 5ppm Note: The gas distribution standard uses clean air as the background gas, the humidity is 50%, and the normal temperature environment
Sensor expected life time	>3 years Note: Temperature (0-25) °C, Humidity (30-70)% RH, the measured gas concentration is within the range, and there is no gas environment that affects the warm-up time mentioned above
Output	The standard output is: 3.3V UART digital signal (see below for communication protocol) ; Optional custom Modbus protocol Interface definition: VCC- Red, GND- Black, RX- Yellow, TX- Green; Baud rate: 9600 Data bits: 8 bits Stop bits: 1 bit
Get data command	The communication is divided into active uploading and Q & A. The default is Q & A mode after power-on. You can use instructions to switch between the two modes. Return to Q & A mode after power off or switch power mode See next page for details
Working Voltage	3.3-5.5V DC
Working Current	< 5mA
Power Consumption	25mW @ 5V DC
Working temperature	(-40 - 55) °C
Optimal working temperature	(20 - 35) °C
Working humidity	(15-95) %RH. (Non-condensing)
Optimum working humidity	50% RH.
Working pressure	Atm ± 10%
Circuit board size	40X30X5.6 (mm)
Module size	With PS1 sensor: 40X30X12 (mm); With PS4 sensor: 40X30X22.45 (mm)
Weight	PS1-VOC-10-MOD < 15g; PS4-VOC-10-MOD < 25g
Temperature and humidity sensor Data	Temperature Range: (-40~85) °C Relative error: ± 0.2 °C Humidity measurement range: (10 ~ 95)% RH non-condensing Relative error: ± 2%
Warranty	12 months from the date of shipment

Structure Diagram (unit in mm)

PS1-VOC-10-MOD Dimension diagram

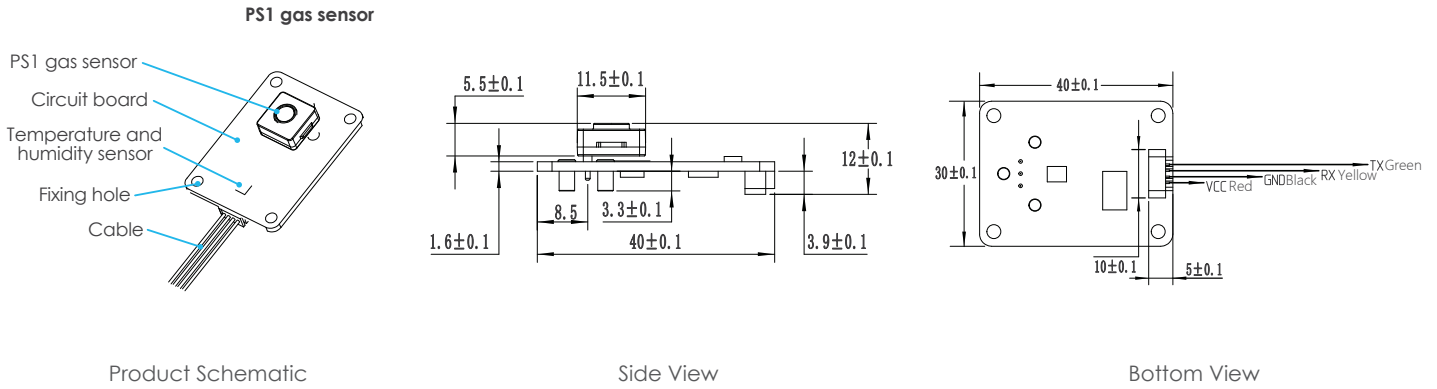

PS4-VOC-10-MOD Dimension diagram

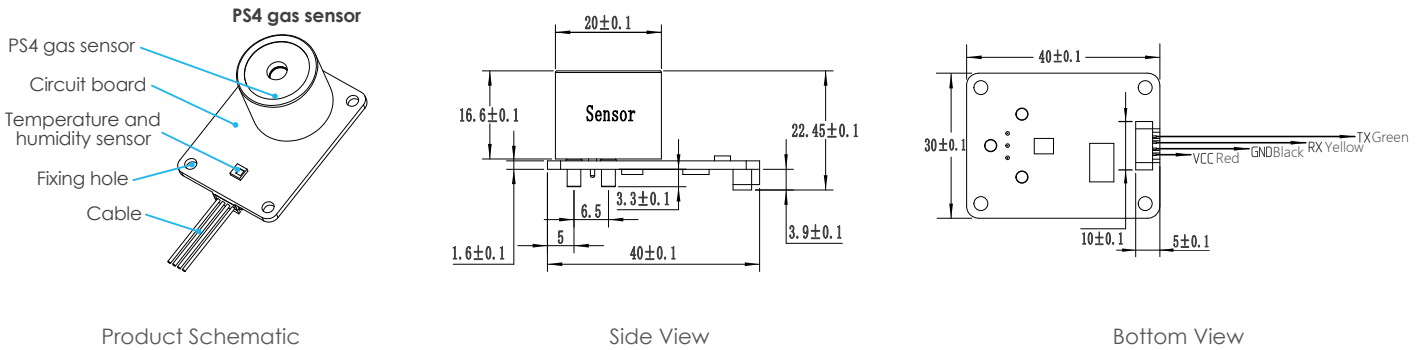

4Pin cable size diagram

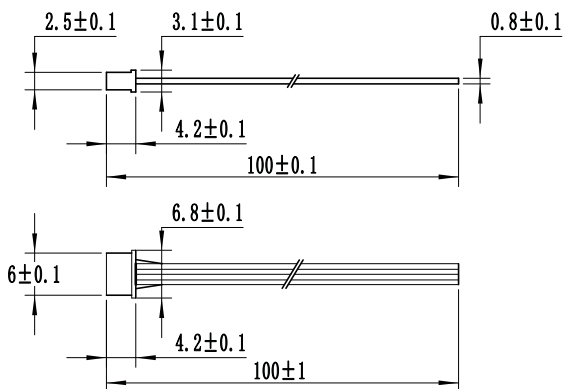

Linearity

Temperature environment: 26 °C; Humidity environment: 55%; Air chamber space: 0.03m³; Ventilation flow of air distribution system: 3000sccm

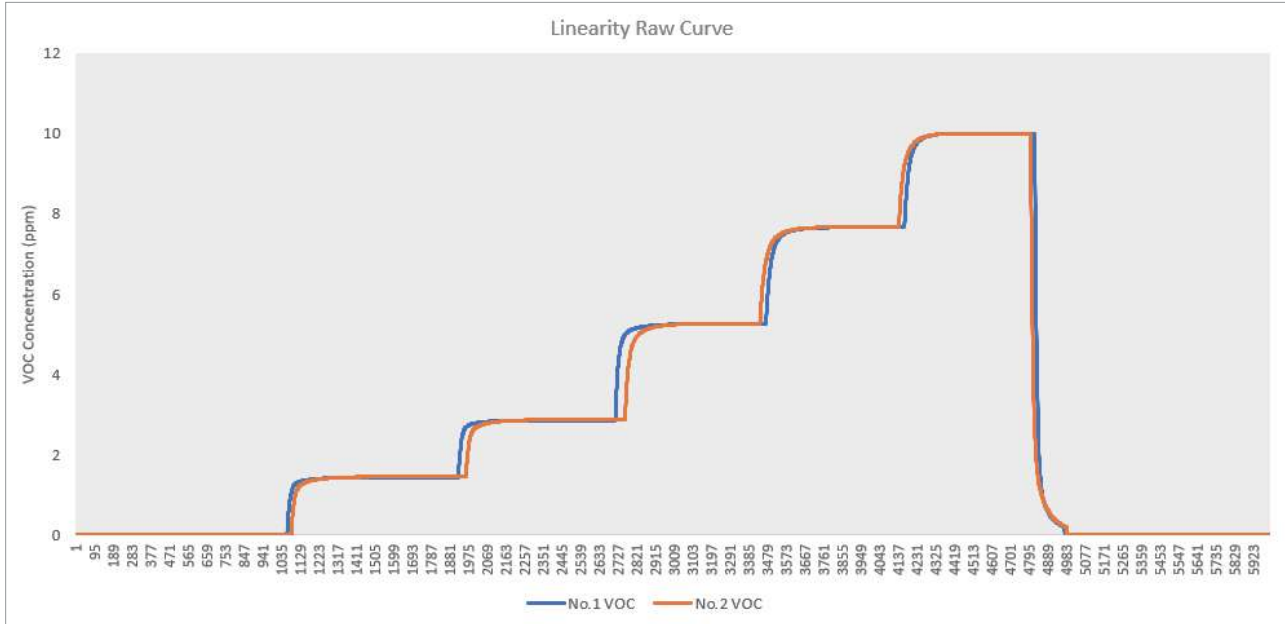

Repeatability

Temperature environment: 26 °C; Humidity environment: 55%; Air chamber space: 0.03m³; Ventilation flow of air distribution system: 3000sccm

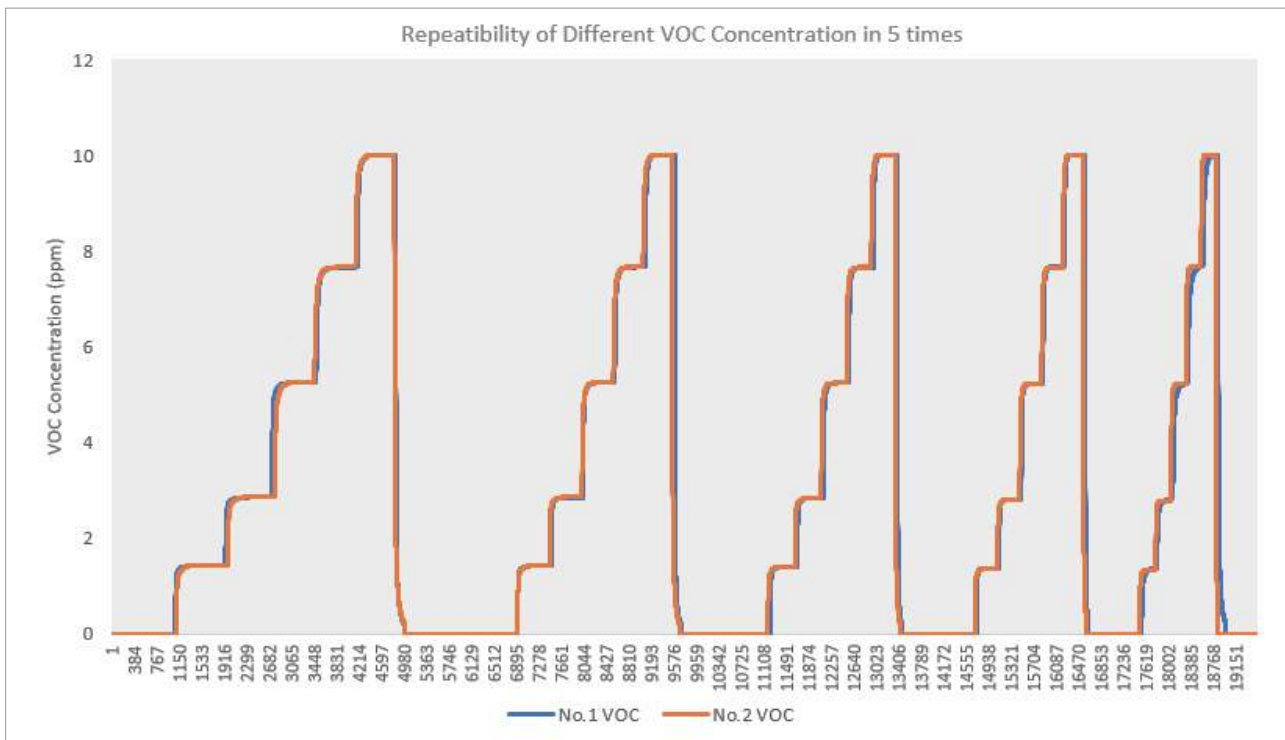

Temperature

Temperature environment: -15, -5, 5, 15, 25, 35, 45, 55° C; air chamber space: 0.03m³; ventilation flow of gas distribution system: 3000sccm,

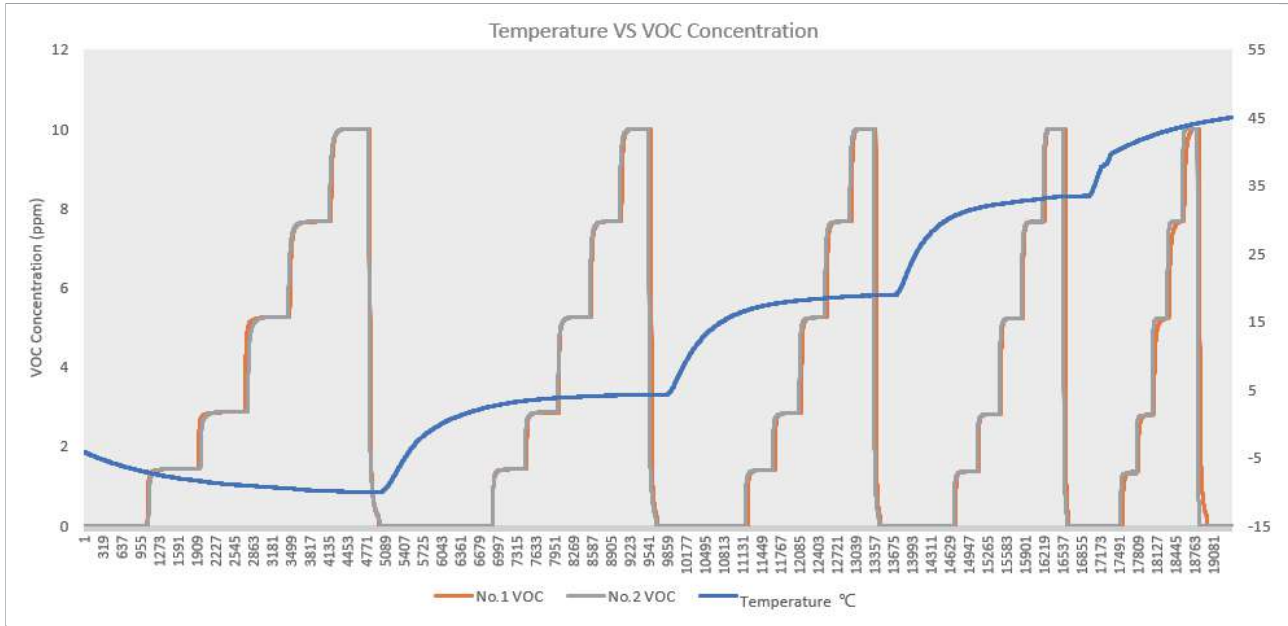

User Guide

Thank you for choosing SGX Sensortech module. Before using it, please read this document in detail in order to use our products correctly and effectively.

Storage

1. The best storage environment is: temperature (-5~30) °C, relative humidity 50% RH (non-condensing);
2. The storage environment should keep the air clean, no pollution gas, no acetone, no high concentration organic gas, no dust, no smoke;
3. Avoid storage with alcohol (ethanol), perfume, sodium silicate and polyurethane liquids or solids;
4. Avoid high temperature and low humidity storage.

Packing and shipping

1. Avoid prolonged direct sunlight during transportation, prevent rainwater penetration;
2. Transport packaging should be protected with shock-proof bubble film or non-odor environmentally friendly sponge;
3. During long-distance transportation, the temperature inside the sensor package should be kept within 40 °C as much as possible, and the maximum temperature should not exceed 55 °C (can not be stored or used at this temperature for a long time), and the humidity should not be less than 15% RH;

Steps for usage

1. Warm-up

- The TVOC module is designed to have a plug-and-play function, but due to the electrochemical nature of the TVOC sensor, after receiving the calibrated product, it still takes about 2 minutes to warm up the machine when it is first powered on. After the output signal is constant, the warm-up is complete.

(Note: under different storage and measurement environments, the first electrode stabilization time is different)

- When warming up, it is recommended to first warm the machine in clean air for about 2 minutes, observe whether the output of the TVOC module is 0ppm (due to storage and environmental differences, the indicated value <0.03ppm can be confirmed as normal), confirm TVOC after the module is normal, put it into the environment under test and let the sensor adapt to its environment. At this time, valid data can be obtained.

2. Connection

- Please refer to the 4Pin cable in the "Structure Diagram" above. For the power supply, see the voltage and current ranges marked in the performance indicators. Note: incorrect wiring will cause the module to malfunction or damage the module.

3. Diffusion use

- When using in a closed environment, it is necessary to ensure a constant pressure and the working pressure range is within $\pm 10\%$ of atmospheric pressure. To ensure accurate measurement data, when using under different pressure environments, re-sensitivity calibration should be performed according to the pressure of the use environment.
- Usually the change of pressure will cause the output signal to change. If the pressure increases, the signal will increase, the pressure change suddenly, and the sensor signal will have a sudden change in peak value.

4. Pump suction use

- When using the sensor in the pumping detection mode, the gas flow rate must be controlled within 500ml per minute, and the flow rate must be stable. The change of flow will cause the signal to fluctuate. When the flow is large, it will bring the change of pressure, which will cause the sensor signal value to change.
- When using the pump suction mode, it is best to add a flow sensor or an air pump control according to the product design to avoid negative pressure and physical damage to the sensor that cannot be recovered.
- The design of the gas path should avoid direct gas flow to the front of the sensor. An optional flow cap should be used, while the air is inlet and the air is outlet (normally small in and large out). The inlet and outlet gas is designed to be 90 degrees or straight-through with a barrier type to ensure that the gas can fully contact the TVOC sensor.

5. Temperature and humidity effects

- The TVOC Gas module has been corrected for temperature compensation through an intelligent algorithm, which is suitable for the detection environment of -40 ~ 55 °C.
- The TVOC sensor module must not be used and stored for a long time in a high-temperature and low-humidity environment with a humidity below 10% or a temperature above 55 °C. Failure to do so will result in reduced sensor life. Either failure or test data is invalid.
- The frequent and rapid changes in temperature or humidity will affect the chemical material and cause an unexpected decrease in the sensor life.
- TVOC sensors are generally not affected by humidity, but during use, it is necessary to avoid condensation blocking the air inlet holes on the surface of the filter membrane, resulting in the inability of TVOC to diffuse into the sensor and no signal output.
- Impact of environmental changes on sensors: Due to the principle and characteristics of electrochemical sensors, environmental changes have varying degrees of influence on the chemical electrolytes inside the sensors. The TVOC detection module analyzes the changes in the current data of the sensor in detail through different environmental temperature and humidity effects tests, and combines the temperature and humidity sensor data to perform algorithmic compensation to correct the resulting deviations. Sudden changes in temperature and humidity will cause abnormal fluctuations in the trace data of the sensor, but generally it can fully adapt to the new environment and be stable within 5-10 minutes.

6. Maintain

- The maintenance of the TVOC detection module is mainly for accuracy calibration. Generally, the solid polymer TVOC sensor does not consume chemical electrolyte, but it can be affected by temperature, humidity, dust, and other gases used in the environment. The sensitivity of the sensor will shift, and the TVOC sensor needs to be re-calibrated. The better the use environment, the longer the maintenance cycle and less maintenance workload.
- In case a calibration is needed the user may make sure that clean air is available or the module can be sent back to the factory for recalibration.

User Guide

Precautions

1. The main function of the gas sensor is to detect the gas composition and content. Please make sure that the sensor is not getting in touch with any liquid;
2. Different gas sensors have different measurement concentration ranges (ranges), and should not be exposed to over-range/high concentrations for a longer time;
3. The sensor is covered with a waterproof and breathable filter (on the top of the sensor), which should not be damaged, scratched or pulled off;
4. Please make sure that the ventilation (filter) surface of the sensor is not blocked or contaminated. Blockage of the filter may lead to a reduced sensitivity, slow response time, or no response.
5. Please do not exchange the sensors of different gas detection modules, this will cause measurement errors, because all the parameters of each sensor and each circuit board are matched and calibrated, there will be deviations after the exchange;
6. Once the PS1 TVOC sensor is unplugged and reinserted into the circuit board, please check that the three electrodes of PS1 correspond to the sockets on the circuit board to avoid irreversible damage to the sensor after reverse insertion;
7. Avoid excessive impact or vibration, such as the shell rupture, reveal the internal structure, the output will not guarantee the effectiveness.

DISCLAIMER:

SGX Europe Sp. z o.o. reserves the right to change design features and specifications without prior notification. We do not accept any legal responsibility for customer applications of our sensors. SGX Europe Sp. z o.o. accepts no liability for any consequential losses, injury or damage resulting from the use of this document, the information contained within or from any omissions or errors herein. This document does not constitute an offer for sale and the data contained is for guidance only and may not be taken as warranty. Any use of the given data must be assessed and determined by the user thereof to be in accordance with federal, state and local laws and regulations. All specifications outlined are subject to change without notice.

SGX Europe Sp. z o.o. sensors are designed to operate in a wide range of harsh environments and conditions. However, it is important that exposure to high concentrations of solvent vapours is to be avoided, both during storage, fitting into instruments and operation. When using sensors on printed circuit boards (PCBs), degreasing agents should be used prior to the sensor being fitted. SGX Europe Sp. z o.o. makes every effort to ensure the reliability of its products. Where life safety is a performance requirement of the product, we recommend that all sensors and instruments using these sensors are checked for response to gas before use.

Copyright© 2012-2022 SGX Sensortech All rights reserved.

Trademarks and registered trademarks are the property of their respective owners.

No part of this publication may be reproduced, distributed, or transmitted in any form or by any means, including photocopying, recording, or other electronic or mechanical methods, without the prior written permission of the publisher, except in the case of brief quotations embodied in critical reviews and certain other non-commercial uses permitted by copyright law.

For permission requests or technical support please contact or write to the publisher, addressed "Attention: Permissions Coordinator,".

Communication Protocol

General settings

The sensor module uses serial communication. The communication configuration parameters are as follows:

Baud rate	9600
Data bits	8 bits
Stop bit	1 bit
Parity bit	None

Note: The communication is divided into active uploading and Q & A mode. The default mode is Q & A mode after power-on. You can use commands to switch between the two modes. After power-off or switching power consumption mode, the mode is restored.

Transmission mode switching instruction

Command 1 Instruction one switches to active upload. The command line format is as follows:

0	1	2	3	4	5	6	7	8
Start bit	Retain	Switch command	Automatic upload	Retain	Retain	Retain	Retain	Proof test value
0 x FF	0 x 01	0 x 78	0 x 40	0 x 00	0 x 00	0 x 00	0 x 00	0 x 47

Note: This format is fixed

Command 2 Switch to passive upload. The command line format is as follows:

0	1	2	3	4	5	6	7	8
Start bit	Retain	Switch command	Answer	Retain	Retain	Retain	Retain	Proof test value
0 x FF	0 x 01	0 x 78	0 x 41	0 x 00	0 x 00	0 x 00	0 x 00	0 x 46

Note: This format is fixed

Get module information instruction

Command 3 Gets sensor type, maximum range, unit, unit decimal places command: 0xD1
Returned value:

0	1	2	3	4	5	6	7	8
Sensor type	Maximum range high	Maximum range low	Unit	Retain	Retain	Retain	Number of decimal places (bit[4]~bit[7]) Data sign (bit[0]~bit[3])	Parity bit
0 x 23	0 x 00	0 x CB	0 x 02	0 x 00	0 x 00	0 x 00	0 x 00	0 x 35

Note:

Max range = (Max range high << 8) | Max range low

Units: 0x02 (ppm and mg / m³) 0x04 (ppb and ug / m³)

Signs: 0 (positive number) 1 (negative number)

Decimal places: how many decimal places to read the concentration value, the maximum number of decimal places is 3

Communication Protocol

Command 4 Get the sensor type, maximum range, unit, and decimal places command: 0xD7

0	1	2	3	4	5	6	7	8
Command header 1	Command header 2	Sensor type	Maximum range high	Maximum range low	Unit	Number of decimal places (bit[4]~bit[7]) Data sign (bit[0]~bit[3])	Retain	Parity bit
0 x FF	0 x D7	0 x 23	0 x 00	0 x C8	0 x 02	0 x 01	0 x 00	0 x 3B

Explanation:

Checksum: 1 ~ 7 bits of data are added to generate an 8-bit data.invert every bit and add 1 to the end

Decimal places bit [4] ~ bit [7]:

(bit[7]<<3) | (bit[6]<<2) | (bit[5]<<1) | bit[4] = decimal places

Data sign (bit[0]~bit[3]):

(bit[3]<<3) | (bit[2]<<2) | (bit[1]<<1) | bit[0] = 0 Negative inhibition

(bit[3]<<3) | (bit[2]<<2) | (bit[1]<<1) | bit[0] = 1 Positive inhibition

Unit :

0x02: unit is mg/m³ and ppm

0x04: unit is um/m³ and ppb

0x08: unit is 10g/m³ and %

Command 5 The format for actively reading the gas concentration value is as follows :

0	1	2	3	4	5	6	7	8
Start bit	Retain	Command	Retain	Retain	Retain	Retain	Retain	Parity bit
0 x FF	01	0 x 86	0 x 00	0 x 00	0 x 00	0 x 00	0 x 00	0 x 79

Returned value:

0	1	2	3	4	5	6	7	8
Start bit	Command	High gas concentration (ug/m ³)	Low gas concentration (ug/m ³)	Full range high	Full range low	High gas concentraton (ppb)	Low gas concentraton (ppb)	Parity bit
0 x FF	0 x 86	0 x 00	0 x 2A	0 x 00	0 x 00	0 x 00	0 x 20	0 x 30

Description:

Checksum: 1 ~ 7-bit data is added to generate an 8-bit data.invert every bit and add 1 to the end

Gas concentration value = high gas concentration *256 + low gas concentration ;

(The high and low concentrations need to be converted from hexadecimal to decimal and then brought into this formula to calculate

Communication Protocol

Command 6 Gas concentration value and temperature and humidity combined reading instruction

0	1	2	3	4	5	6	7	8
Start bit	Retain	Command	Retain	Retain	Retain	Retain	Retain	Parity bit
0 x FF	0 x 00	0 x 87	0 x 00	0 x 00	0 x 00	0 x 00	0 x 00	0 x 79

Returned value:

0	1	2	3	4	5	6	7	8	9	10	11	12
Start bit	Command	High gas concentration (ug/m ³)	Low gas concentration (ug/m ³)	Full range high	Full range low	High gas concentration (ppb)	Low gas concentration (ppb)	Temperature high	Temperature low	Humidity high	Humidity low	Parity bit
0 x FF	0 x 87	0 x 00	0 x 2A	0 x 03	0 x E8	0 x 00	0 x 20	0 x 09	0 x C4	0 x 13	0 x 88	0 x DC

Description:

Checksum: 1 ~ 11 bits of data are added to generate an 8-bit data, each bit is inverted, and 1 is added at the end.

Gas concentration value = high gas concentration * 256 + low gas concentration;

(The high and low concentrations need to be converted from hex) adecimal to decimal and then brought into this formula to calculate

Temperature is signed data with two decimal places (°C-Celsius) Pseudo code calculation formula:

$$T = (\text{float})((\text{int})((0x0A \ll 8) | 0x09)) / 100$$

Humidity is data without signs and two decimal places. The unit is (rh%). Pseudo code calculation formula:

$$Rh = (\text{float})((\text{uint})((0x0A \ll 8) | 0x09)) / 100$$

Command 7 Get the current temperature and humidity

Returned value:

0	1	2	3
Temperature high 8 bit	Temperature low 8 bit	Humidity high 8 bit	Humidity low 8 bit
0 x 0A	0 x 09	0 x 11	0 x F4

Description:

Temperature is signed data with two decimal places and the unit is (°C-Celsius)

Pseudo code calculation formula:

$$T = (\text{float})((\text{int})((0x0A \ll 8) | 0x09)) / 100$$

Humidity is data without sign and two decimal places, the unit is (rh%)

Pseudo code calculation formula:

$$Rh = (\text{float})((\text{uint})((0x0A \ll 8) | 0x09)) / 100$$

Communication Protocol

Command 8 Get the current temperature and humidity with calibration
Returned value:

0	1	2	3	4
Temperature high 8 bit	Temperature low 8 bit	Humidity high 8 bit	Humidity low 8 bit	Checksum
0 x 0A	0 x 09	0 x 11	0 x F4	0 x E8

Description:

Checksum: 0 ~ 3 digits of data are added to generate an 8-bit data. Each bit is inverted, plus 1 at the end
Temperature is data with a sign and two decimal places. The unit is (°C-Celsius)

Pseudo code calculation formula:

$$T = (\text{float})((\text{int})((0x0A \ll 8) | 0x09)) / 100$$

Humidity is data with no sign and two decimal places in units (rh%).

Pseudo code calculation formula:

$$Rh = (\text{float})((\text{uint})((0x0A \ll 8) | 0x09)) / 100$$

Command 9 Get the current version number
Returned value:

0	1	2	3	4	5
0 x 19	0 x 05	0 x 27	0 x 00	0 x 10	0 x 01

Data in active upload mode

The upload data format is as follows:

0	1	2	3	4	5	6	7	8
Start bit	Command	High gas concentration (ug/m ³)	Low gas concentration (ug/m ³)	Full range high	Full range low	High gas concentration (ppb)	Low gas concentration (ppb)	Parity bit
0 x FF	0 x 86	0 x 00	0 x 2A	0 x 00	0 x 00	0 x 00	0 x 20	0 x 30

Note:

Checksum: Add 1 to 11 digits of data to generate 8 digits of data, invert each bit, add 1 at the end

Gas concentration value = high gas concentration * 256 + low gas concentration

(The high and low concentrations need to be converted from hexadecimal to decimal and then brought into this formula to calculate)

Low power switching

Enter sleep mode

0	1	2	3	4	5
0 x AF	0 x 53	0 x 6C	0 x 65	0 x 65	0 x 70

Returned value :

0	1
0 x 4F	0 x 4B

Communication Protocol

Exit sleep mode

0	1	2	3	4
0x AE	0x 45	0x 78	0x 69	0x 74

Returned value :

0	1
0x 4F	0x 4B

Note: after exiting sleep mode, it takes 5 seconds to recover, no data within 5 seconds

Enter sleep mode

0	1	2	3	4	5	6
0x A1	0x 53	0x 6C	0x 65	0x 65	0x 70	0x 32

Returned value :

0	1	2	3	4	5	6	7	8
0x FF	0x A1	0x 00	0x 00	0x 00	0x 00	0x 00	0x 00	5F

Exit sleep mode

0	1	2	3	4	5
0x A2	0x 45	0x 78	0x 69	0x 74	0x 32

Returned value :

0	1	2	3	4	5	6	7	8
0x FF	0x A2	0x 00	0x 00	0x 00	0x 00	0x 00	0x 00	5E

Communication Protocol

Turn off the running lights

0	1	2	3	4	5	6	7	8
Start bit	Retain	Command	Retain	Retain	Retain	Retain	Retain	Checksum
0 x FF	0 x 01	0 x 88	0 x 00	0 x 00	0 x 00	0 x 00	0 x 00	0 x 77

Return :

0	1
0 x 4F	0 x 4B

Turn on the running lights

0	1	2	3	4	5	6	7	8
Start bit	Retain	Command	Retain	Retain	Retain	Retain	Retain	Checksum
0 x FF	0 x 01	0 x 89	0 x 00	0 x 00	0 x 00	0 x 00	0 x 00	0 x 76

Return :

0	1
0 x 4F	0 x 4B

Query the running light status

0	1	2	3	4	5	6	7	8
Start bit	Retain	Command	Retain	Retain	Retain	Retain	Retain	Checksum
0 x FF	0 x 01	0 x 8A	0 x 00	0 x 00	0 x 00	0 x 00	0 x 00	0 x 75

Return :

0	1	2	3	4	5	6	7	8
Start bit	Command	State value	Retain	Retain	Retain	Retain	Retain	Checksum
0 x FF	0 x 8A	0 x 01	0 x 00	0 x 00	0 x 00	0 x 00	0 x 00	0 x 75

Note: Status value 1 (light on), 0 (light off)