

Low Profile Shielded SMD Chip Power Inductor



ASPI-0312FS



3.0 x 3.0 x 1.2mm
RoHS/RoHS Compliant

Features

- Small size and low profile: 1.2mm
- Small DCR and high rated current
- High reliability to mechanical stress
- Magnetically shielded by magnetic powder molding
- Suitable for RoHS reflow profile

Applications

- Mobile phones
- MP3 & 4 and other portable communication equipment
- Digital cameras

Electrical Specifications

Operating Temperature & Humidity:	-40°C to +125°C (Including self generated heat)
Storage Temperature & Humidity:	-40°C to +125°C

Part Number ASPI-0312FS Inductance Code	Inductance	Inductance Tolerance	DC Resistance		Saturation Current	Temperature Rise Current	Self-Resonant Frequency
			Max	Typ			
Units	μH	%	mΩ	mΩ	A	A	MHz
Symbol	L	M, N	DCR		Isat	Irms	SRF
ASPI-0312FS-R22	0.22	N	22	17	5.3	3.0	321
ASPI-0312FS-R82	0.82	N	39	30	2.05	2.47	180
ASPI-0312FS-1R0	1.0	N	52	40	1.87	2.20	120
ASPI-0312FS-1R2	1.2	N	59	45	2.22	2.01	120
ASPI-0312FS-1R5	1.5	N	59	45	1.62	2.01	110
ASPI-0312FS-1R8	1.8	N	82	63	1.30	1.65	90
ASPI-0312FS-2R2	2.2	N	98	75	1.20	1.55	84
ASPI-0312FS-2R4	2.4	N	88	68	1.15	1.60	100
ASPI-0312FS-2R7	2.7	M	110	85	1.14	1.48	65
ASPI-0312FS-3R3	3.3	M	130	100	1.05	1.36	64
ASPI-0312FS-3R6	3.6	M	130	100	1.05	1.36	36
ASPI-0312FS-3R9	3.9	M	189	145	1.00	1.24	61
ASPI-0312FS-4R7	4.7	M	156	120	0.90	1.24	61
ASPI-0312FS-6R8	6.8	M	247	190	0.75	0.98	61
ASPI-0312FS-100	10.0	M	345	265	0.60	0.83	42
ASPI-0312FS-120	12.0	M	449	345	0.48	0.73	32
ASPI-0312FS-150	15.0	M	468	360	0.45	0.71	27
ASPI-0312FS-180	18.0	M	709	545	0.43	0.58	25
ASPI-0312FS-220	22.0	M	839	645	0.42	0.53	23

Low Profile Shielded SMD Chip Power Inductor



ASPI-0312FS



3.0 x 3.0 x 1.2mm
RoHS/RoHS Compliant

Electrical Specifications cont.

Part Number ASPI-0312FS Inductance Code	Inductance	Inductance Tolerance	DC Resistance		Saturation Current	Temperature Rise Current	Self-Resonant Frequency
			Max	Typ			
Units	μH	%	$\text{m}\Omega$	$\text{m}\Omega$	A	A	MHz
Symbol	L	M, N	DCR		Isat	Irms	SRF
ASPI-0312FS-270	27.0	M	1131	870	0.35	0.47	21
ASPI-0312FS-330	33.0	M	1138	875	0.36	0.46	18
ASPI-0312FS-360	36.0	M	1235	950	0.34	0.44	18
ASPI-0312FS-390	39.0	M	1729	1330	0.30	0.37	18
ASPI-0312FS-470	47.0	M	1885	1450	0.27	0.35	14
ASPI-0312FS-560	56.0	M	1794	1380	0.26	0.28	9
ASPI-0312FS-680	68.0	M	2171	1670	0.24	0.33	7
ASPI-0312FS-820	82.0	M	3302	2540	0.17	0.27	7
ASPI-0312FS-101	100.0	M	3718	2860	0.21	0.25	5

Test Conditions

1. Inductance is measured using a WK3260B LCR meter or equivalent.
2. DCR is measured using HIOKI 3540 or equivalent.
3. Isat : Based on inductance change ($\Delta L/L_0 : \leq -30\%$)
4. Irms : Based on temperature rise ($\Delta T : 40^\circ\text{C TYP.}$)
5. SRF: Agilent E4991A+16197 or equivalent.
6. Test Freq: 100KHz, 1Vrms

Part Number Identification

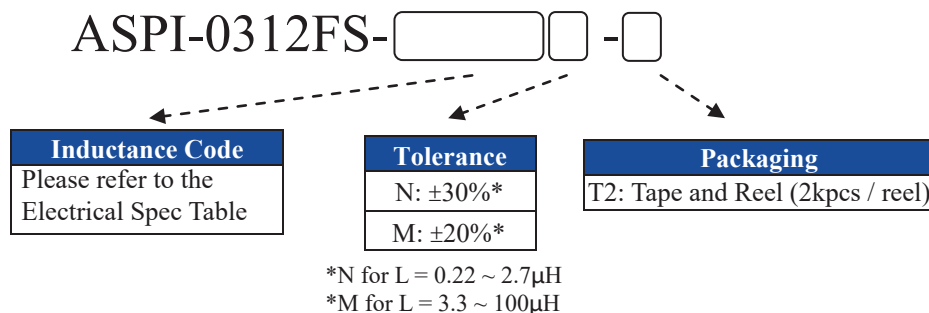

Low Profile Shielded SMD Chip Power Inductor



ASPI-0312FS



3.0 x 3.0 x 1.2mm
RoHS/RoHS Compliant

Mechanical Information

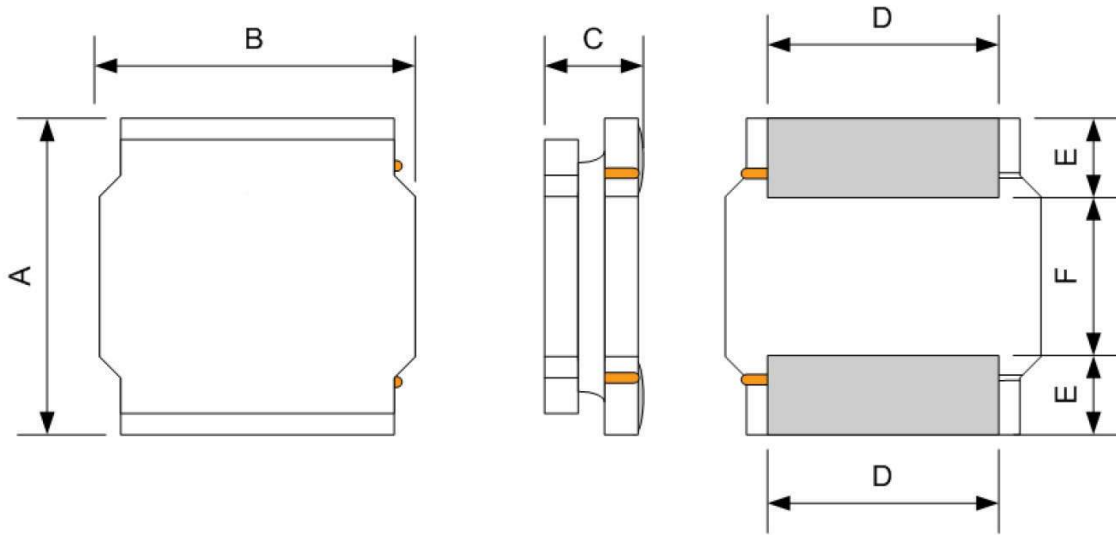

A	B	C	D	E	F	a Typ.	b Typ.	C Typ.
3.0 ± 0.2	3.0 ± 0.2	1.2 Max	2.50 ± 0.2	0.75 ± 0.2	1.5 ± 0.2	1.5	0.8	2.7

Circuit Schematic

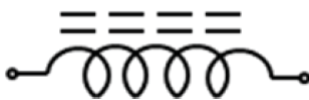

No Polarity

Recommended Land Pattern

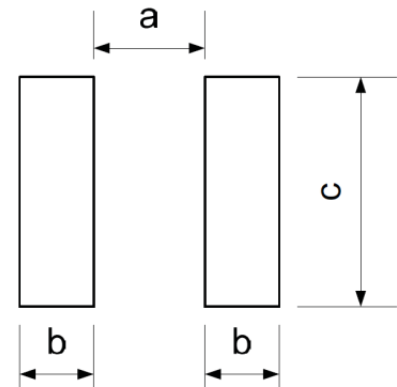

Dimensions: mm

Low Profile Shielded SMD Chip Power Inductor



ASPI-0312FS



3.0 x 3.0 x 1.2mm
RoHS/RoHS Compliant

Reflow Profile

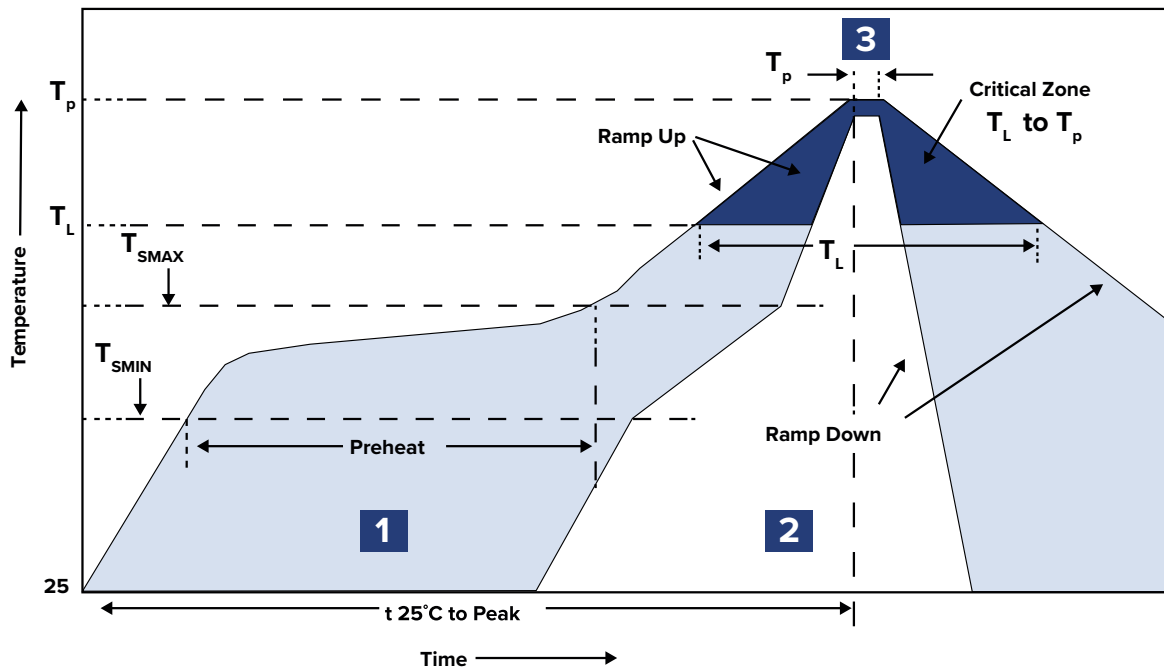

Zone	Description	Temperature	Time
1	Preheat / Soak	$T_{SMIN} \sim T_{SMAX}$ 150°C ~ 200°C	60 ~ 120 sec.
2	Reflow	T_L 217°C	60 ~ 90 sec.
3	Peak heat	T_P 260°C	10 sec. MAX

Low Profile Shielded SMD Chip Power Inductor



ASPI-0312FS



3.0 x 3.0 x 1.2mm
RoHS/RoHS Compliant

Packaging

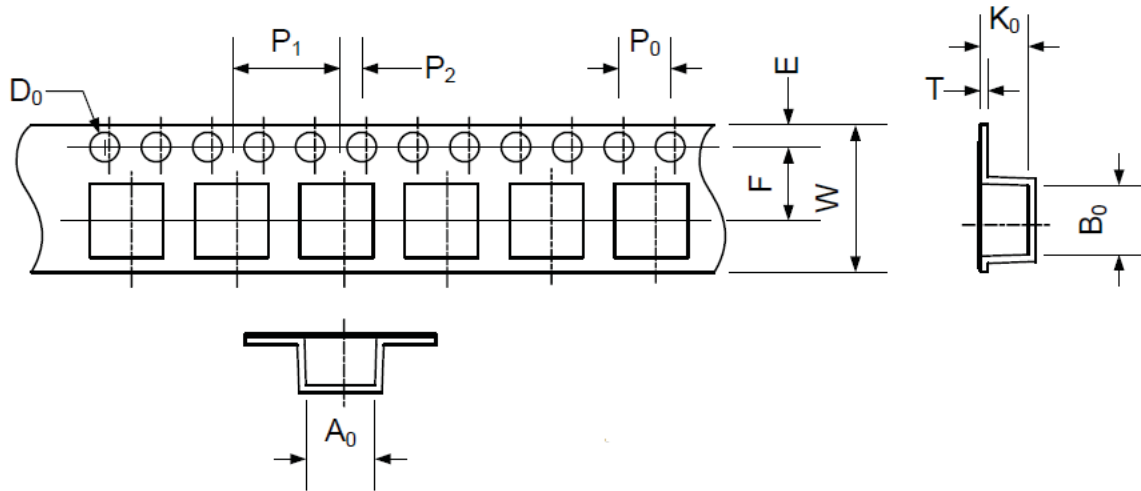

A_0	B_0	W	E	F	P_0	P_1	P_2	D_0	T	K_0
3.3 ± 0.1	3.3 ± 0.1	8.0 ± 0.3	1.75 ± 0.1	3.5 ± 0.05	4.0 ± 0.1	4.0 ± 0.1	2.0 ± 0.1	1.5 +0.1/-0.0	0.25 ± 0.03	1.6 ± 0.1

Dimensions: mm

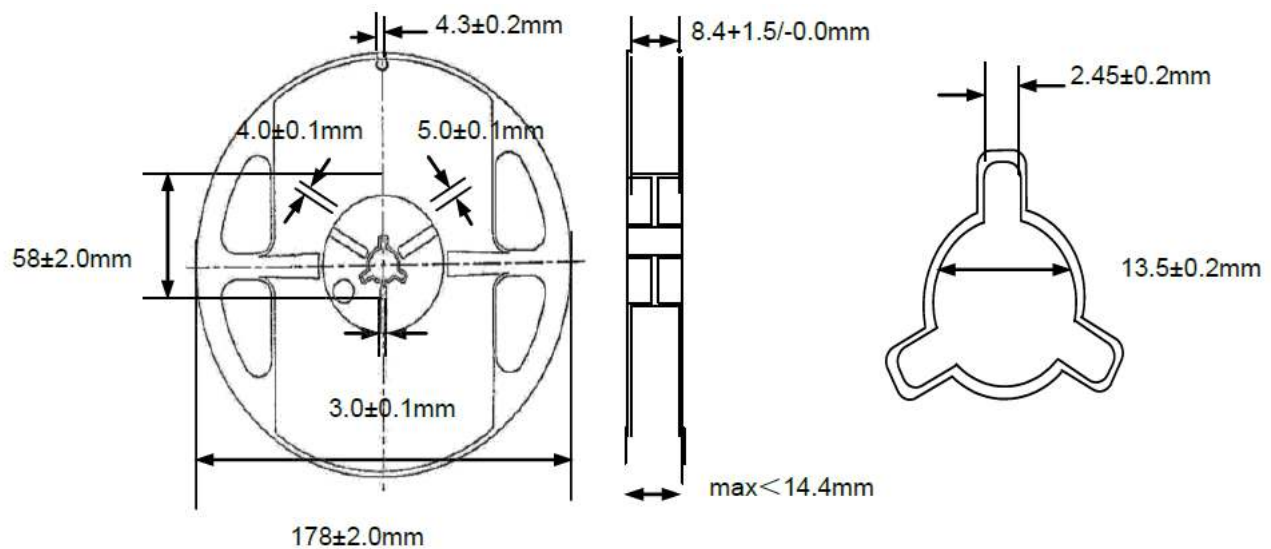

ATTENTION: Abracon LLC's products are COTS – Commercial-Off-The-Shelf products; suitable for Commercial, Industrial and, where designated, Automotive Applications. Abracon's products are not specifically designed for Military, Aviation, Aerospace, Life-dependent Medical applications or any application requiring high reliability where component failure could result in loss of life and/or property. For applications requiring high reliability and/or presenting an extreme operating environment, written consent and authorization from Abracon LLC is required. Please contact Abracon LLC for more information.



5101 Hidden Creek Ln Spicewood TX 78669
Phone: 512-371-6159 | Fax: 512-351-8858
For terms and conditions of sales, please visit:
www.abracon.com

REVISED: 04-14-20

ABRACON IS
ISO9001-2015
CERTIFIED