

Type BLC-108 Fuse Block 8 Pole – Regular Auto Blade



www.optifuse.com

(619) 593-5050

Specifications:

Max Current Rating: 25A per Circuit - 150A Max Input

Max Voltage: 32VDC

Fuse Type: Regular Auto Blade (APR series)

Base: Polycarbonate

Terminals: 8 ea Copper, Tin plated 0.250" Quick Connect Terminals,

1 ea #10-32 stud terminal with hex nut, flat washer and lockwasher supplied.

Mounting: 4 mounting holes for #10-32 screws (not supplied)

Cover available: BLC-108-C

Mechanical Dimensions: Inches [mm]

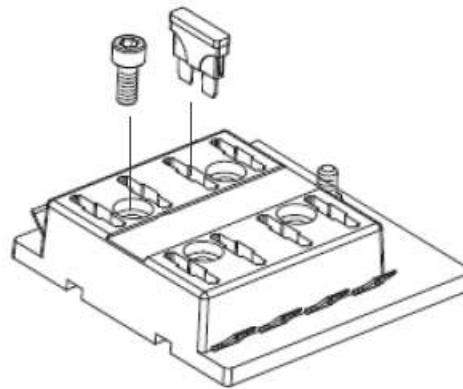
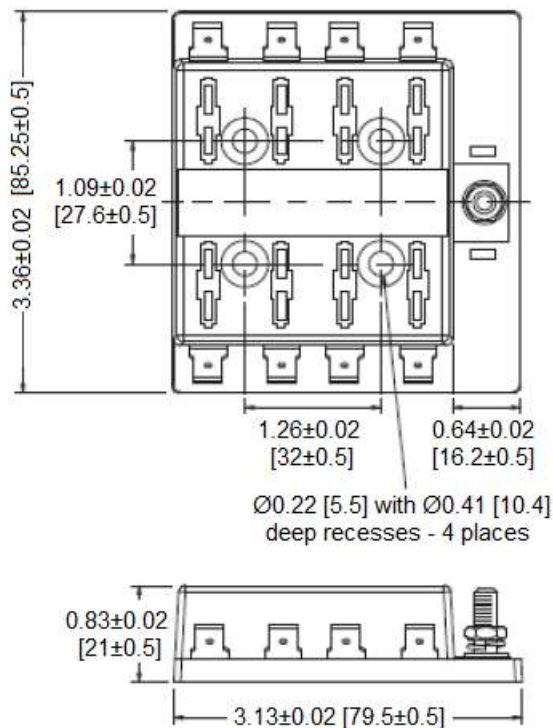

Warning:



-Operation beyond the specified maximum ratings or improper use may result in damage and possible electrical arcing and/or flame.

-Avoid contact of device with chemical solvent. Prolonged contact may damage the device performance.

Note: All specifications subject to change without notice.

Rev C 01/2012 - Page: 1/1
Code B01-01H