

WDF 82-9167-4
WMS STM

Zeichnung geschützt durch © Copyright 1982 AMP DEUTSCHLAND GmbH Alle Rechte vorbehalten	Index	Anderung	Tag	Name

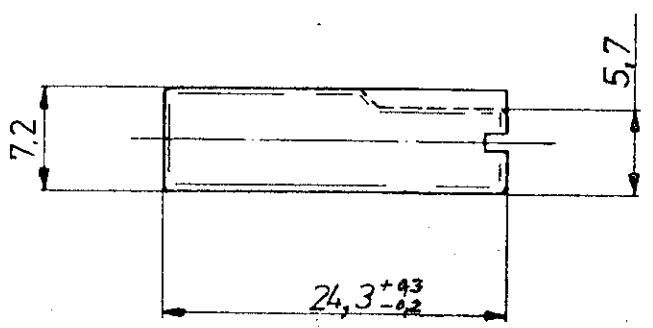

Schnitt section A-A

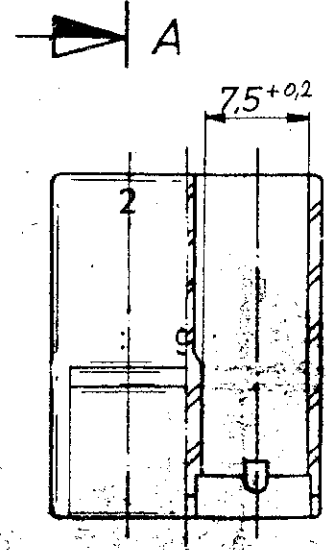
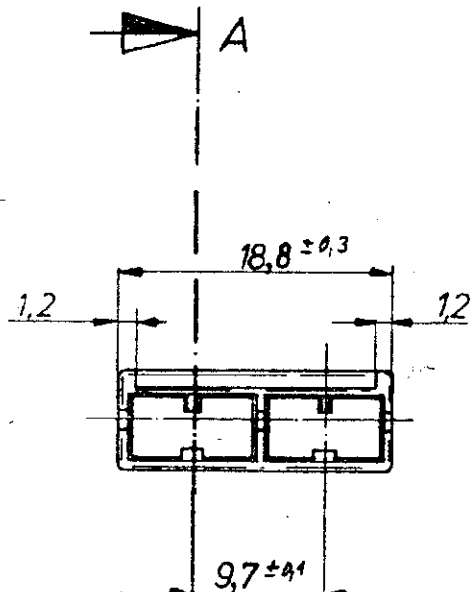
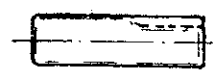
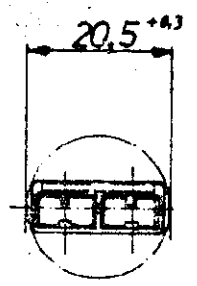
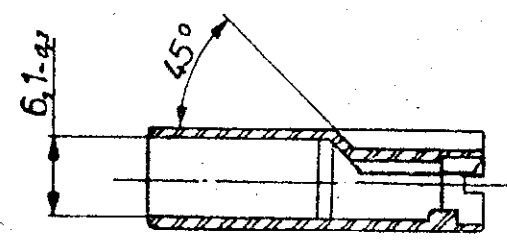

Maßstab scale 1:1

Anderungen, die dem technischen Fortschritt dienen, behalten wir uns vor.

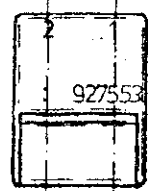

		AMP AMP DEUTSCHLAND GmbH Langen b Ffm	
		Benennung 2 pol. POSITIVE LOCK Gehäuse	
927 553-1	PA 6.6	schwarz	
Bestell-Nr.	Werkstoff	Oberfläche Farbe	Nicht tolerierte Maße ± 0,2 mm ± 1°-30'
Gez. 11.3.85 Druft	12.3.85 Wly	Gepr.	Format B Zeichnungs-Nr. 927 553
		Maßstab 2:1	Blatt-Nr. 1 von 1

K